

# Zieher online catalogue

Welcome to the online catalogue.

Similar to the printed version, you may browse the catalogue at your own leisure. Additionally in the online version we offer the option to add the desired items to your shopping basket and to submit with a few clicks only.

**For a short video demonstration of the functions please click [here](#).**

Enjoy browsing through our catalogue and request your personal offer with a few clicks.



With the “More catalogues” button you also have the option to choose between different catalogues (if available) and add more items to your shopping basket.



Items may be put onto the shopping list to save them for a later inquiry.



Clicking on the “view items” button, a detailed list of all items featured on the displayed catalogue page will open.

ZIEHER



2020  
PROFESSIONAL





represents innovative design in high-quality craftsmanship and is appreciated for more than 30 years as a reliable partner for luxury hotels and high class gastronomy. Impressive buffet performances, luxurious food presentations and exclusive home accessories bear the name Zieher around the globe. Since 2015, unique wine glasses and decanters are also on offer.



Zieher products are destined for the most demanding customers and convince with the highest quality, exquisite materials and unique design. The range is constantly being developed in close cooperation with professional chefs and top hoteliers and thus always offers new inspiration for extraordinary presentations.

A stylized, handwritten signature in black ink, which appears to read 'M. Zieher'.

Manfred Zieher

All information about Zieher and the complete product range is available at [www.zieher.com](http://www.zieher.com).



page 5



page 141



page 183



page 199



page 227

## Buffet

5

- buffet displays: etagere / display "Falcon" - "Somnia" - "Spike" - "Textura"
- buffet displays: "Crossline"
- buffet systems: "Skyline" - "Squareline" - "Curve"
- The Zieher-System: "StiXXX" - "V12" - "Basic" - "Luxor" - "Classy" - "Solid" - "Konkret!" - "Antique" - "Lightning Buffet"
- cooling element "Chiller-Base"
- buffet platters made of natural stone, laminated plastic and glass, buffet steps made of glass
- buffet stands "Stablo"
- buffet bowls made of pewter, brass, shell, glass, stainless steel and walnut
- buffet etageres
- serving tongs
- "Fingerfood-Tree"
- serving trays and buffet systems made of walnut: "Mercato" - "Solid"
- buffet bridges and trays "Podia"

## Catering

121

- Bento Box
- melamine trays and accessories
- serving trays and cutlery boxes
- tray system "Modul": walnut - melamine - glass and china inserts

## China, glass and more!

141

- main series and small series made of china / glass
- china plates, platters, trays, bowls and small bowls
- glass plates, platters, trays, bowls and small bowls
- napkin ring made of pewter
- cloches made of glass
- charger plates

## Wine glasses and more!

183

- wine decanter / carafe "Star" - "Star" mini
- basic ring with LED for decanter "Star" and "Eddy"
- wine decanter "Eddy" - "Eddy" mini
- wine decanter "Pebble"
- wine glass series VISION
- champagne flute "Vaganza"

## Miniatures

199

- anti-slip coasters made of silicone
- glass miniatures, borosilicate glass, double-walled glass
- china miniatures
- stainless steel miniatures
- skewers and natural stone
- party cutlery, amuse gueule / tapas spoons, glass- and honey spoons

## Cruet stands, trays, etageres and more!

227

- trays made of melamine and wood
- Bento Box made of melamine
- chocolate / truffles boxes, suitable inserts made of solid surface material
- bread baskets / boxes, trays and snack boards made of walnut
- etageres made of stainless steel
- jam trays and food displays
- vinegar / oil bottles
- cruet stands and trays with suitable inserts
- trays made of melamine and glass with 3 / 4 sockets for inserts
- wind lights and accessories

## Room service / guestrooms

271

- roomservice trays and accessories
- storage / presentation boxes, cutlery box "Solid"
- displays and trays "Podia"
- etagere "DressCoat"
- coat rack "Kibu"

## List of items in ascending order

281

## Table of content

287

# Excellence since 1986 - Exclusive design since 2006

In the year 2006 we designed the first items ourselves and placed them on the market. Since that time developing and implementing exclusive design objects has been our calling. On this page we show a couple of the most important creations of the past years.

Design, innovation and quality are our mission!



[WWW.ZIEHER.COM](http://WWW.ZIEHER.COM)  
PHOTOGRAPHY: [www.die-lichtzeichner.de](http://www.die-lichtzeichner.de)



# The Zieher Design History



2015

2017

2019

2014

2016

2018



Solid, page 104-119



Falcon, page 6, 7



Star, page 183-187



StiXXX, page 27



# NEWS 2020!

Reef, page 64-67



XXL-Bowl, page 73



Flex-Tree, page 91



Splash, page 63





# Buffet







**etagere "Falcon"**

massive stainless steel 18/10, highly polished, dishwasher-safe, food-safe, anti-slip silicone sleeves for use with buffet platters included

item	l x w x h in cm
8086	24x20x45



**buffet platter, laminated plastic**

laminated plastic, 8 mm thick, dark grey, black intermediate ply, break-proof, scratch-proof, dishwasher-safe, antistatic, deburred edges, rounded corners

item	version	l x w in cm
8006.08	rectangular	80x21
8006.14	rectangular	91x21
8006.15	rectangular	102x21



**coup plate "Catering"**

china, white, round, flat

item	Ø in cm	PU
3954.21	21	12 pcs



**coup plate "Catering"**

china, matt black, round, flat

item	Ø in cm	PU
3954.23S	23	12 pcs



**plate "Rough!"**

china, matt black, round, structured surface

item	Ø in cm	PU
4567.24	24	4 pcs





More buffet platters made of laminated plastic are available on pages 48 and 49.



Anti-slip sleeves provide a safe positioning of buffet platters.

## "Falcon" - really detached!

This etagere, inspired by the elegance of a falcon, is giving wings to the creativity at the buffet. A single one can bear up to three plates on its wings or, when used as a duo, fitting buffet platters or a combination of both can be installed. Anti-slip supports can be plugged on if needed and thus provide a safe positioning of the platters.

As a high-tea stand, the etagere carries plain white coup plates or matt-black plates with a slate-like structure. Those plates fit exactly into the slots of the wings.

The mirror polished, solid stainless steel (3 mm) punctuates the precious impression of the dynamic shape, incorporated handrails facilitate the service. This majestic creature is sitting on a stylized branch, which also provides a firm stand.





# "Somnia"



2386.10 + 4814.40 + 4685



## candle holder/wind light "Somnia"

brass, golden, matt, not dishwasher-safe, for glass insert item 4991.02 (please order separately) and candles up to Ø 7 cm

item	Ø stand in cm	Ø top in cm	height in cm
2383.01	11	approx. 16.5	approx. 19.5



## wind light

borosilicate glass, satined inside, open at the top and the bottom, for candle holder/wind light "Somnia" item 2383.01

item	Ø in cm	height in cm	PU
4991.02	9	14.5	6 pcs



## buffet display "Somnia"

brass, golden, matt, not dishwasher-safe

item	Ø in cm	height in cm
2386.10	approx. 21.5	approx. 10.5
2386.20	approx. 21.5	approx. 20.5



## protecting cap

rubber, black, for buffet display "Somnia" items 2386...

item	Ø in cm	PU
4685	0.4	10 pcs



## display for bowls "Somnia"

brass, golden, matt, not dishwasher-safe

item	Ø in cm	height in cm	for glass bowl
2385.01	approx. 15.5	approx. 13.5	4814.17
2385.02	approx. 23.5	approx. 22.5	4814.23



## glass bowl

dark grey, round, handblown, ground edge

item	Ø in cm	height in cm	content in l
4814.17	17	5.5	approx. 0.3
4814.23	23	9.5	approx. 1.5
4814.30	30	13	approx. 3.25
4814.40	40	10	approx. 4.5





2385.01 + 4814.17

2385.02 + 4814.23

At first glance the golden branches, carefully strapped to a bundle, are reminiscent of a besom and braided objects of a different kind. The buffet displays and luminaires of the "Somnia" series are assembled from organically shaped, filigree rods which are made of solid brass in traditional sand casting. These single components, reminiscent of brittle branches, are afterwards melded in complex handicraft to impressive unique pieces. The matt-golden surface of the "Somnia" series harmonizes elegantly with the grey glass of the handblown bowls, which have been specially adapted to the shape of the small stands. The two bigger buffet raisers form a precious basis for bowls and buffet platters of all kind. Optionally available black rubber caps can be fixed if required to improve the slip resistance and to protect the sensitive surface of furniture. The smallest version of these little pieces of art also impresses at a set table. An amuse-bouche, bedded on a nest of golden branches, will be treasured by the guests for a long time.



The wind light of the "Somnia" series is equipped with a solid base plate with an elevated rim. This base avoids a leakage of wax and protects the table surface from heat. Furthermore, it forms the frame for a removable cylinder, made of heat resistant glass, which by way of its satined surface, intensifies the mood of light and protects the flame from wind at the same time. With candlelight, this extraordinary lighting object creates fascinating effects and provides for a cosy and comfortable ambience.



# "Spike"



## Modern and compact - bowl displays "Spike"

The anthracite coloured displays of the "Spike" series consist of translucent acrylic with a silk-matt surface. They are an elegant combination of shapely elements with a flexibility, suitable for everyday usage. As the stands have been adapted exactly to the grey glass bowls belonging to the series, they form a harmonious picture and additionally provide a safe stand. A combination of the stands/trestles with buffet platters – even in a flipped position – is also possible and increases the usefulness of the displays enormously.

The plug connections between the single items are very practical. They are compatible with one another within one size of stands which guarantees a maximum of variability and creative freedom. Existing elements can therefore be newly arranged and extended almost arbitrarily by buying additional single items.

The displays of the "Spike" series are available in ten single units for several bowl sizes as well as ten pre-configured sets. Optionally available wooden transport and storage boxes simplify a space-saving storage of the single pieces.

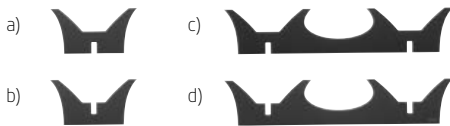

### buffet display "Spike" S - parts

acrylic glass, 6 mm thick, anthracite, satined, translucent, size S for glass bowl item 4814.17

item	version	l x h in cm
a) 8260.10	top part onefold	11.6x6
b) 8260.1U	bottom part onefold	11.6x6
c) 8260.20	top part twofold	30.3x6
d) 8260.2U	bottom part twofold	30.3x6

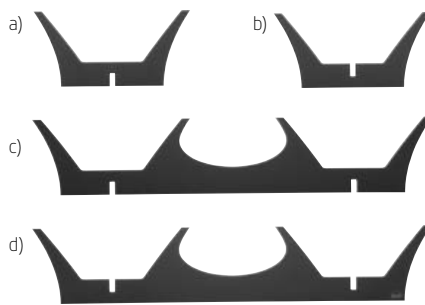

### buffet display "Spike" M - parts

acrylic glass, 6 mm thick, anthracite, satined, translucent, size M for glass bowl item 4814.23 und 4814.30

item	version	l x h in cm
a) 8261.10	top part onefold	20.8x10
b) 8261.1U	bottom part onefold	20.8x10
c) 8261.20	top part twofold	52.6x10
d) 8261.2U	bottom part twofold	52.6x10

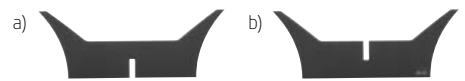

### buffet display "Spike" L - parts

acrylic glass, 6 mm thick, anthracite, satined, translucent, size L for glass bowl item 4814.40

item	version	l x h in cm
a) 8262.10	top part onefold	24.7x9
b) 8262.1U	bottom part onefold	24.7x9



### glass bowl

dark grey, round, handblown, ground edge

item	Ø in cm	height in cm	content in l
4814.17	17	5.5	0.3



### glass bowl

dark grey, round, handblown, ground edge

item	Ø in cm	height in cm	content in l
4814.23	23	9.5	1.5
4814.30	30	13	3.25



### glass bowl

dark grey, round, handblown, ground edge

item	Ø in cm	height in cm	content in l
4814.40	40	10	4.5





"Spike" offers numerous possible ways of combinations and extensions. We have a selection of different pre-configured sets in our assortment which can be combined with each other or extended with the also available individual parts.



**buffet display "Spike", set S**

acrylic glass, 6 mm thick, anthracite, satined, translucent, pluggable

item	consists of items	for glas bowl item
a) 8260.01	8260.10 (1x) / 8260.1U (1x)	4814.17
b) 8260.02	8260.10 (2x) / 8260.2U (1x)	4814.17
c) 8260.03	8260.10 (1x) / 8260.1U (1x) / 8260.20 (1x) / 8260.2U (1x)	4814.17
d) 8260.04	8260.20 (2x) / 8260.2U (2x)	4814.17
e) 8260.05	8260.10 (2x) / 8260.20 (1x) / 8260.2U (2x)	4814.17



**buffet display "Spike", set M**

acrylic glass, 6 mm thick, anthracite, satined, translucent, pluggable

item	consists of items	for glas bowl item
a) 8261.01	8261.10 (1x) / 8261.1U (1x)	4814.23 and 4814.30
b) 8261.02	8261.10 (2x) / 8261.2U (1x)	4814.23 and 4814.30
c) 8261.03	8261.10 (1x) / 8261.1U (1x) / 8261.20 (1x) / 8261.2U (1x)	4814.23 and 4814.30
d) 8261.04	8261.20 (2x) / 8261.2U (2x)	4814.23 and 4814.30



**buffet display "Spike", set L**

acrylic glass, 6 mm thick, anthracite, satined, translucent, pluggable

item	consists of items	for glas bowl item
8262.01	8262.10 (1x) / 8262.1U (1x)	4814.40

5665.01



5665.02



**storage/transportation box**

veneer plywood, dovetailed corners, 1 divider

item	l x b x h in cm	for Buffetdisplay "Spike" item
5665.01	34x16x8.5	8260...
5665.02	56x25x13	8261... and 8262...





# "Textura"



The cloches and porcelain bowls and plates of the series "Cuspis" are available on page 144 and 172.

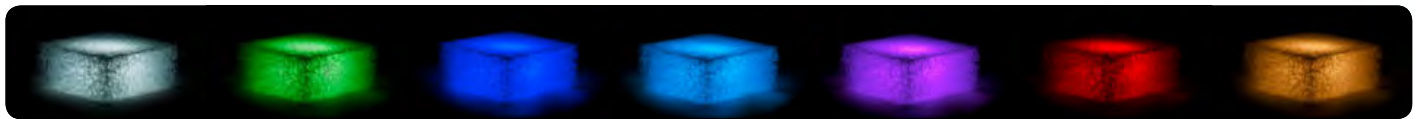

In order to grant a harmonic all-over illumination while using stacked cuboids, it is recommended to use one LED lamp per item. For usage of bigger buffet platters, we suggest to employ the elements with 30 cm edge length. Due to the flexible material, we recommend stacking a maximum of two cubes on top of each other, when the system is equipped with heavy platters or bowls.



Precisely fitting recess for ZIEHER LED lights (page 44 / 45)



## buffet display "Textura"

polyethylene, transparent, with notch for rechargeable LED-light item 8150

item	l x w x h in cm
8232.24	approx. 24x24x10.5
8232.30	approx. 30x30x10.5



## “Textura” - indestructible, innovative, exclusive!

The exclusive cuboids of the „Textura“ series are exceedingly interesting, even at a second glance, due to their awesome structure. They consist of thin polyethylene filaments, which are convoluted intricately and fused together. This awards them a flexible but nevertheless very stable texture. The true potential of this innovative material is only disclosed in connection with light. The light-conducting properties of the filigree filaments manifest effectively when using the rechargeable Zieher LED light (page 44/45), which fits exactly into the cut-outs on the bottom side of the displays.

The “Textura” buffet cuboids are available in two sizes which, when used separately or stacked on top of each other, create different presentation levels on the buffet. Buffet platters and trays are reliably kept in position due to the non-slip features of this material. “Textura” lives up to the high demands of gastronomy and catering in numerous ways. The displays are indestructible and very light, washable and dirt-repellent. The countless interspaces create a light-flooded meshwork, which dries very quickly and is therefore resistant to humidity and mold. Also the raw material itself is something to be proud of. Polyethylene can repeatedly be 100% recycled without losing its outstanding characteristics. It is physiologically non-hazardous, odorless, tasteless and resistant to a variety of acids, oils and grease.



All information about the cooling elements “Chiller Base” can be found on pages 40 and 41.



# "Crossline"

The buffet platters "Industry 2.0" are available on page 49.



Buffet bowls in copper PVD coating are available upon request.



## buffet bowl

glass, 8 mm thick, dark grey, oval, structured, delivery in strong wooden box

item	l x w x h in cm
5176	130x42x8

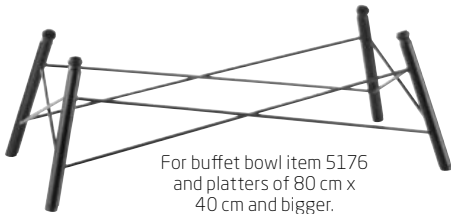

For buffet bowl item 5176 and platters of 80 cm x 40 cm and bigger.

Hinged beams at the upper side of the trestle can be adjusted individually to the shape of bowls and platters.



For buffet bowl item 5176 and platters of 80 cm x 40 cm and bigger.

## buffet stand "Crossline"

galvanised steel, matt black (powder coating), rectangular, hinged beams on top

item	l x w x h in cm	l x w in cm (on top)
8325.23	70.5x33.5x23.5	59.5x22



For buffet bowl item 5704 (page 73) and platters of 42 cm x 42 cm and bigger.



## buffet stand "Crossline" - rust

steel, rusted surface, transparent sealing, rectangular, hinged beams on top

item	l x w x h in cm	l x w in cm (on top)
8325.23R	70.5x33.5x23.5	59.5x22



For buffet bowl item 5704 (page 73) and platters of 42 cm x 42 cm and bigger.

## buffet stand "Crossline"

galvanised steel, matt black (powder coating), square, hinged beams on top

item	l x w x h in cm	l x w in cm (on top)
8320.15	41.5x41.5x15.5	34x34
8320.31	49.5x49.5x31	34x34

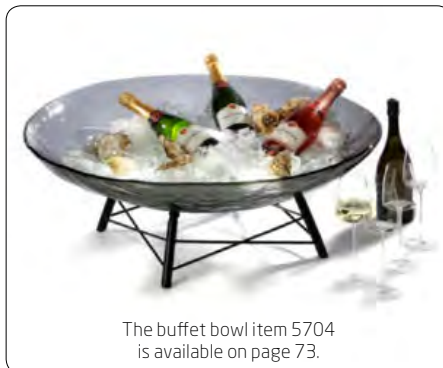

The buffet bowl item 5704 is available on page 73.

## buffet stand "Crossline" - rust

steel, rusted surface, transparent sealing, square, hinged beams on top

item	l x w x h in cm	l x w in cm (on top)
8320.15R	41.5x41.5x15.5	34x34
8320.31R	49.5x49.5x31	34x34





More dark grey glass bowls are available on pages 72 to 77.

## Filigree understatement!

The filigree displays of the "Crossline" series feature an enormous stability due to their cleverly elaborated statics. These elements, which have been deliberately designed to have a plain and restrained appearance, unobtrusively blend into every ambience.

The rectangular base has been constructed especially for a presentation bowl made of dark grey glass, which impresses by its length of 130 cm. Hinged beams at the upper side of the trestle can be adjusted to the shape of the bowl individually. Hence also Zieher buffet platters of 80 cm x 40 cm and bigger can be installed. The supports are felt-covered, which minimises disturbing noise, evens out smaller asperities and provides for slip-resistance. Two more versions in square shape are constructed identically and are, in example, suitable for buffet platters in sizes 42 cm x 42 cm or 50 cm x 50 cm.

All trestles are made of galvanised steel and afterwards coated with a robust and scratch-proof powder-coating in a classy matt black. Therefore the stands are also suitable for outdoor areas. A second variant of raw steel with a rusted and sealed surface inspires by the charm of corroded metal and perfectly matches the industrial style of modern architecture! Low weight, space-saving storage due to its stackability, easy handling and quick installation are just a few advantages of the "Crossline" series. The matt black colouring of the stands can be combined harmoniously with many different materials. Thanks to the large variety of Zieher buffet platters, the arrangement of buffets can be redesigned again and again.



The dark grey glass bowls are available on page 72, our complete range of buffet platters is available on pages 46 to 54.

# "Skyline" - Manhattan-Feeling on the buffet



"Skyline", Zieher's buffet system, allows a maximum of flexibility for the most exclusive buffet presentations. Different heights enable you to install big buffet platters on the one hand - on the other hand, they can be stabilised by insertion into the corresponding serration. The square columns are made of highly-polished stainless steel and due to the standardised serration heights, they can be combined with the "Squareline" (pages 22 to 24) and "Curve" series (page 25).

The spectacular look that brings the silhouette of skyscrapers to mind, is available in a highly-polished version and for an intensified effect, also in black and white colouring (gold and copper on request!). The optionally available Zieher LED-lights are a perfect addition to the system and come in 2 versions: cabled and rechargeable (pages 44 and 45). In combination with light-diffusing tubes (page 44), they provide a perfect illumination of the system in various colours.



The buffet platters are available on page 53.





Buffet platters made of grey glass are available on page 53,  
black glass trays and glass steps on page 54.

“Skyline” - the original!





# "Skyline"- the original

Buffet platters made of glass, laminated plastic and slate are available from page 46 onwards.



## buffet stand "Skyline"

massive stainless steel 18/10, matt black (powder-coated), square, not dishwasher-safe

item	l x w x h in cm
8300.10	25x25x10.5
8300.22	25x25x22.5
8300.34	25x25x34.5
8300.58	32x32x58.5

## buffet stand "Skyline"

massive stainless steel 18/10, white (powder-coated), square, not dishwasher-safe

item	l x w x h in cm
8305.10	25x25x10.5
8305.22	25x25x22.5
8305.34	25x25x34.5
8305.58	32x32x58.5

## buffet stand "Skyline"

massive stainless steel 18/10, highly polished, square, dishwasher-safe, food-safe

item	l x w x h in cm
2177.10	25x25x10.5
2177.22	25x25x22.5
2177.34	25x25x34.5
2177.58	32x32x58.5

The glass bowl item 5308.26 are available on page 170.



The LED-lights, either as rechargeable or cable version, are available on pages 44 and 45.



## acrylic glass tube

satined (white), removable lid for easy fitting of bowls etc., notch for cable for LED-light item 8104 (not included, please order separately)

item	Ø in cm	height in cm	PU
8122.10	12	10	3 tubes
8122.22	12	22	3 tubes
8122.34	12	34	3 tubes
8122.58	12	58	3 tubes



**silicone sleeve**

transparent, slotted lengthwise, for buffet stand "Squareline" items 8081..., 8082..., 8084... and buffet stand "Skyline" items 2177..., 8300... and 8305... (prevents the slipping of buffet platters)

item	length in cm	PU
4684	2	10 pcs

**Storage and transportation trolley**  
 We are happy to offer you an individual solution for transportation and storage of your miscellaneous items.  
**Please ask us!**



The displays of the series "Skyline" and many other items made of stainless steel can be refined to gold and copper versions. All information about refining of stainless steel in PVD process on page 80.





# "Skyline"



Please note: The bread baskets from the "Skyline" series have a closed base plate and rubber feet. They deviate in height from the buffet stands items 2177...



## fruit/bread basket "Skyline"

massive stainless steel 18/10, highly polished, square, with bottom plate and 4 rubber feet

item	l x w x h in cm
2179.10	25x25x11.5
2179.22	25x25x23.5
2179.34	25x25x35.5

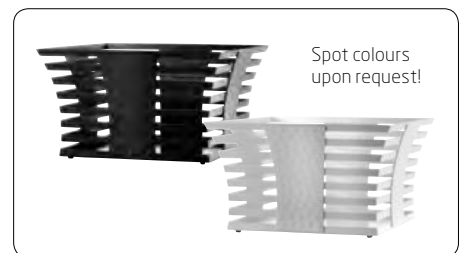

Spot colours upon request!



## fruit/bread basket "Skyline"

massive stainless steel 18/10, highly polished, square, with bottom plate and 4 rubber feet

item	l x w x h in cm
2178.23	40x40x23.5

The bowl "Sixth Sense" is available on page 83.





## "Skyline" made by Zieher - Compare the original to copies of inferior quality!

Reasons to stick with the original:

- Different versions: polished, matt black and white (golden and copper on request)
- Highest Zieher quality and perfect accuracy in manufacturing
- Compatibility with other Zieher systems
- 100 % fitting illumination
- Massive stainless steel 18/10
- Design by Zieher in 2009



Cabled and rechargeable, battery-powered LED-lights are available on pages 44 and 45.

The "Skyline" buffet system allows a maximum of flexibility for the most exclusive buffet presentations.

Due to the same serration heights, the "Skyline" system is combinable with our "Squareline" (pages 22 to 24) and "Curve" systems (pages 25). The different adaptors of the "Squareline" system may equally be used with the "Skyline" stands (exception: columns with 58 cm height).

Please note: Due to constructional reasons, the combination of "Skyline" with the walnut adaptor (item 4736) can only be illuminated with limitations.

Some exemplary displays can be seen here:



"Skyline" black, connector pieces acrylic glass satined (page 24), acrylic glass tubes (page 18), rechargeable LED-lights (page 45).

"Skyline" white, walnut connector piece (page 24), walnut tray (page 234).

"Skyline" highly polished, connector pieces acrylic glass black (page 24), platters black glass (page 50), acrylic glass tubes (page 18), rechargeable LED-lights (page 45).

# "Squareline"



"Squareline" black, acrylic connector pieces satined (page 24), glass platters grey (page 53), "Lightning Buffet" tubes (page 44), rechargeable LED-lights (page 45).

The rechargeable LED-light (item 8150, optionally available, page 45) offers numerous fixedly pre-installed colours, as well as special programs like colour gradient and flickering-candle-effect. The compatible remote control (item 8151) allows the synchronization of up to 20 LED-lights at the same time and enables the change of the complete buffet-colouring by just pressing one button!

Alternatively and especially for fixed buffet installations, we recommend the use of the Zieher LED-lights with cable (item 8104, page 44). With this item, 5 lighting colours can be set by using stick-on colour-filters.

The connector pieces feature slots, so that the cables can be laid invisibly through the columns of the "Lightning Buffet". To do this, the detachable lids of the acrylic tubes have to be removed. If cabled LED-lights are used, it is recommended to lay down all components of a "Squareline"- tower next to each other on the table to facilitate the installation of the cables.

Please note: To illuminate the system, you will need one LED-light and one acrylic column in the fitting size (12 resp. 24 cm) for each "Squareline" stand. The acrylic columns are available in sets of 3 pieces (items 8120..) and can be found on page 44, the information on our LED-lights can be found on pages 44 and 45.



"Squareline" polished, connector pieces walnut wood (page 24), buffet platters made of glass (page 50-54), trays "Solid" walnut wood (page 114), glass steps transparent (page 54).

"Squareline" black, acrylic connector pieces black (page 24), glass platters black (page 50), glass steps black (page 54).





# "Squareline", the buffet system with 1000 faces!



"Squareline" white, acrylic connector pieces black (page 24), glass platters black (page 50), glass steps black and glass trays black (page 54).

Our classic "Skyline" has been changed and advanced to become "Squareline", which now offers several new features apart from its pure design.

The stainless steel displays are available in two heights. Three versions - highly polished, matt black and white (golden and copper on request), grant the columns completely different effects! The "Squareline" towers can be stacked on top of each other by using connector pieces, which are available in three different versions. A 90° rotated arrangement of the stands increases the creative leeway tremendously and permits a buffet set-up at an angle.

Besides the technical aspect, the connector pieces are mainly a decorative element. They are available in glossy black as well as satined, light-diffusing acrylic. The third version is handmade from solid walnut wood in best quality. In connection with the various displays and buffet platters, countless possibilities for the creation of a buffet arise.

Optionally, "Squareline" offers the possibility of a 100 % integration of our "Lightning Buffet" - the full height of the columns will be illuminated from the inside. When using the satined connector pieces, their light-diffusing effect even enhances the spectacular sight. The system is based on the buffet classic "Skyline" (pages 16 to 21), both in construction and in form. So both systems can be combined quite easily.

Just let your imagination run wild!



"Squareline" polished, acrylic connector pieces satined (page 24), platters transparent glass (page 52), buffet platter (page 74) and glass steps transparent (page 54), "Lightning Buffet" tubes (page 44), rechargeable LED-lights (page 45).



# "Squareline"



## silicone sleeve

transparent, slotted lengthwise, for buffet stand "Squareline" items 8081..., 8082..., 8084... and buffet stand "Skyline" items 2177..., 8300... and 8305... (prevents the slipping of buffet platters)

item	length in cm	PU
4684	2	10 pcs



## buffet stand "Squareline"

massive stainless steel 18/10, highly polished, square, dishwasher-safe, food-safe

item	l x w x h in cm
8081.13	24x24x13.5
8081.25	24x24x25.5



## buffet stand "Squareline"

massive stainless steel 18/10, white (powder-coated), square, not dishwasher-safe

item	l x w x h in cm
8084.13	24x24x13.5
8084.25	24x24x25.5



## buffet stand "Squareline"

massive stainless steel 18/10, matt black (powder-coated), square, not dishwasher-safe

item	l x w x h in cm
8082.13	24x24x13.5
8082.25	24x24x25.5



## walnut connector "Squareline"

food-safe sealed, not dishwasher-safe, with 4 holes for cable run

item	l x w x h in cm
4736	27x27x7



## acrylic connector "Squareline"

clear satined (translucent), with 4 stainless steel pins and 4 holes for cable run

item	l x w x h in cm
8083.01	27x27x3.5

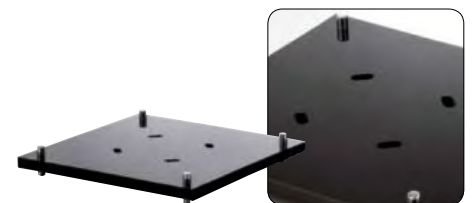

## acrylic connector "Squareline"

black, glossy, with 4 stainless steel pins and 4 holes for cable run

item	l x w x h in cm
8083.02	27x27x3.5



cabled LED-light, page 44

rechargeable LED-light, page 45

acrylic tubes, items 8120..., page 44

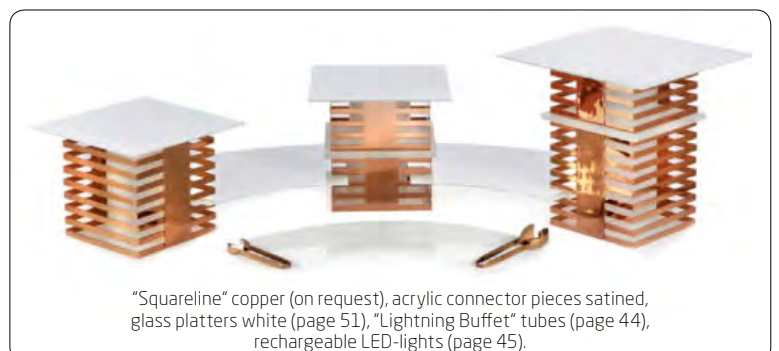

"Squareline" copper (on request), acrylic connector pieces satined, glass platters white (page 51), "Lightning Buffet" tubes (page 44), rechargeable LED-lights (page 45).



## Flexibility with a concept

"Curve" is made of 3 mm strong, galvanised steel with a high grade powder coating. This guarantees great stability and corrosion-resistance. The gaps between the bars were expressly chosen by the Milanese designer Itamar Harari to make the raisers completely compatible with the systems "Skyline" (pages 16 to 21) and "Squareline" (pages 22 to 24). The attractively priced "Curve" is therefore not only suitable as a starter version, but also as an optimal extension of existing systems.

During the development of "Curve", special attention was given to the mobile usage. Thus all components can be stored in an extremely space-saving way. Simple and swift to install, "Curve" is the perfect equipment for outdoor areas, events and catering.

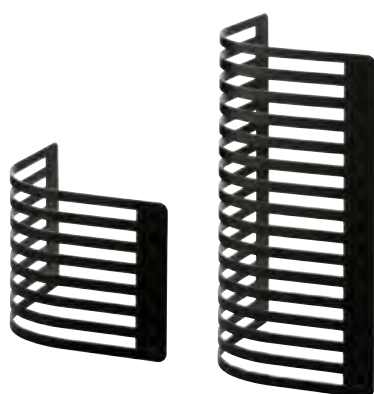

### buffet stand "Curve"

galvanised steel, 3 mm thick, matt black (powder-coated), not dishwasher-safe

item	l x w x h in cm	PU
8310.22	27x27x22.5	2 pcs
8310.46	27x27x46.5	2 pcs

Design: Itamar Harari





# The "Zieher-System"

Zieher offers innumerable possibilities to present food optically appealing and highly flexible. When developing new buffet products, it is most important for Zieher to guarantee compatibility among the individual systems.

The "Zieher-System" with its different heights of 12, 24 and 36 cm or 8, 16, and 24 cm leads to a perfect composition of different presentation levels on the buffet, thus offering more flexibility in its arrangement. A wide range of buffet platters and trays of hardened glass, natural slate and laminated plastic in various styles are available on pages 46 to 53.

Thanks to the boundless possibilities, varying materials and designs, every buffet can easily be adapted to any accommodation. The system becomes part of the whole interior and assimilates harmonically into any ambiance.

## "Konkret!" (from page 37 on)

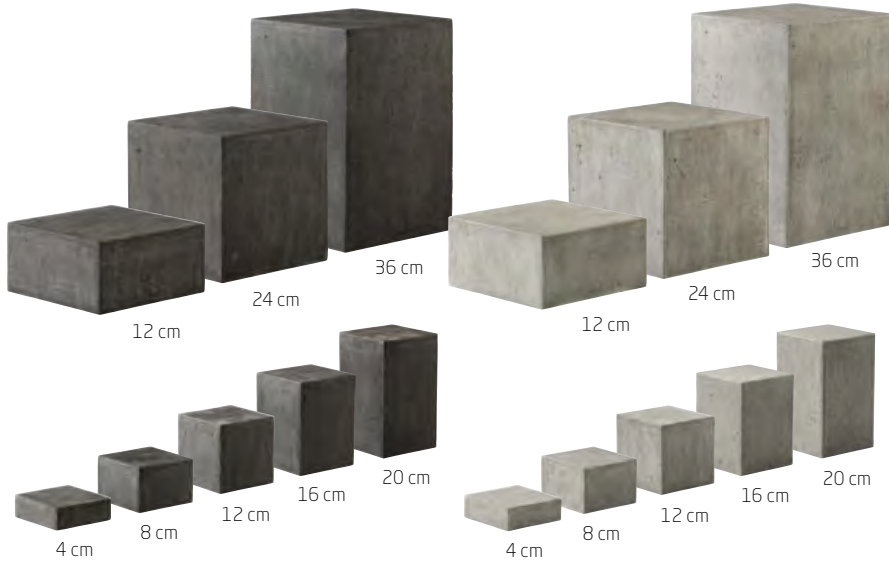

## NEW "StiXXX" (page 27)

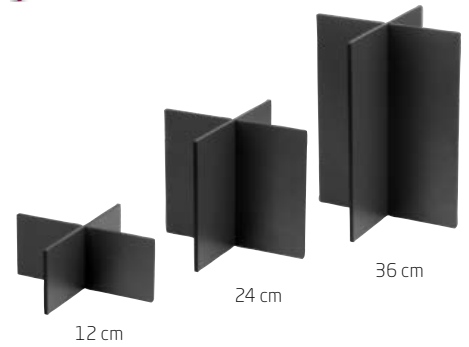

## "Basic" (from page 30 on)



## "V12" - Carbon (from page 28 on)

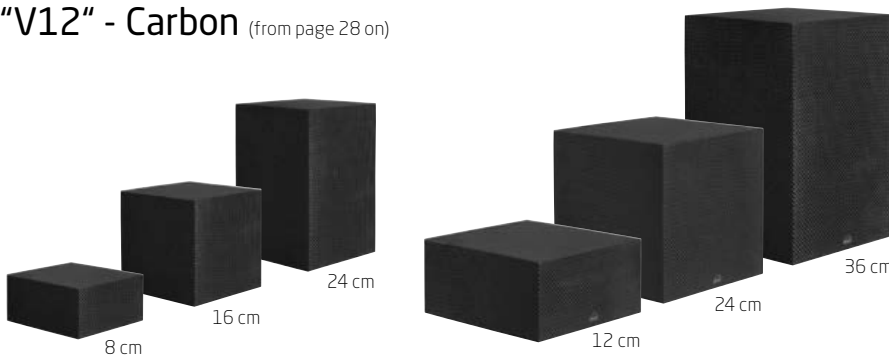

## "Solid" (page 36)



## "Classy" (from page 34 on)



## "Antique" (page 42)



## "Luxor" (from page 32 on)

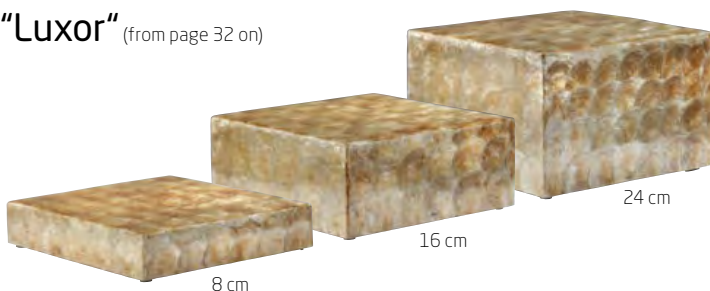

## "Lightning Buffet" (from page 43 on)

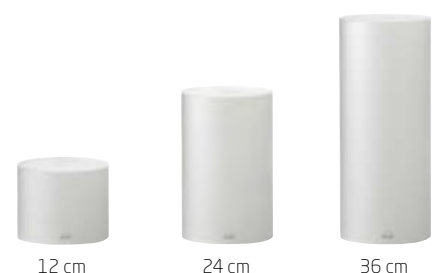

The trays made of grey glass are available on page 165.  
 Buffet platters made of laminated plastic are available on page 48/49.

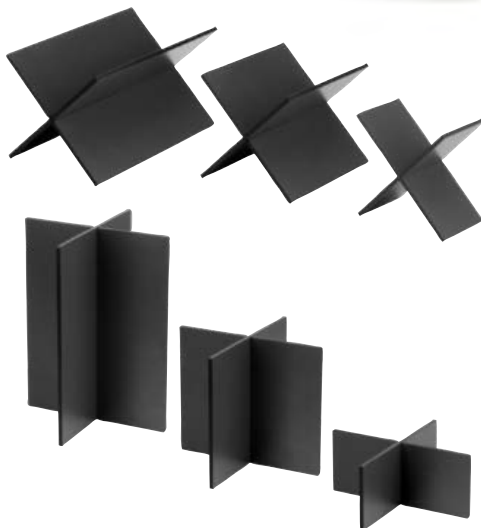

**buffet display "StiXXX"**

laminated plastic, 8 mm thick, dark grey, black intermediate ply, break-proof, scratch-proof, dishwasher-safe, antistatic, deburred edges, rounded corners, pluggable, 1 set (2 parts)

item	l x w x h in cm
8060.12	20x20x12
8060.24	20x20x24
8060.36	20x20x36

The indestructibility of laminated platters meets the advantages of plug-in systems. The plain displays are loosely stuck together, which ensures a quick and uncomplicated set-up as well as a space-saving storage of the single components. Thereby "StiXXX" meets in particular the hard requirements of daily use in the catering business.

The heights of the puristic displays match perfectly with other series of the Zieher-System, by what creates numerous possible combinations. Positioned as an "X" results in further presentation possibilities with a particularly slight and filigree alignment. The Zieher buffet platters and displays made of laminate are usable on both sides by the double-sided decoration. This exceedingly robust raw material is break- and scratch-proof, antistatic and dishwasher-safe and thus offers numerous advantages compared to other raw materials.

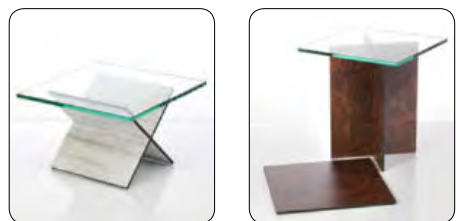
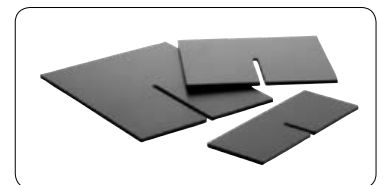

Special decor "Vintage" and "Industry 2.0" (page 49) upon request.





# "V12" - Carbon

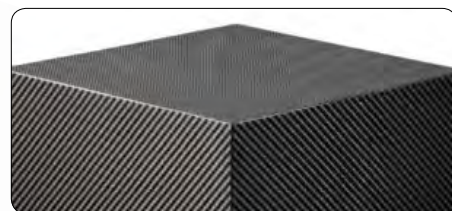

## buffet display "V12"

carbon fibre (fabric), high-gloss, black, not dishwasher-safe, splashproof, bottom side closed

item	l x w x h in cm
8206.08	20x20x8
8206.16	20x20x16
8206.24	20x20x24



## buffet display "V12"

carbon fibre (fabric), high-gloss, black, not dishwasher-safe, splashproof, bottom side closed

item	l x w x h in cm
8205.12	24x24x12
8205.24	24x24x24
8205.36	24x24x36



The complete range of buffet platters is available on pages 46 to 54.

"V12" combines modern and reduced forms with the precious material carbon. The elegant and three-dimensional look of the carbon fibre paired with maximum stability - "V12" adds high-tech to the buffet!

In connection with the huge Zieher assortment of buffet platters, "V12" provides a maximum in flexibility and best usage of buffet surfaces. Six different sizes of the "V12" displays offer a lot of possibilities for the individual composition of your buffet.

The standard heights of the carbon buffet displays of 12, 24 and 36 cm resp. 8, 16 and 24 cm permit an easy and simple combination with other Zieher systems. For an overview, please consult page 26.



The buffet stands "Basic" are available on page 30, the cloches on pages 173 to 176.





"Basic"



Food: Pâtisserie Walter ([www.patisserie.de](http://www.patisserie.de))



**buffet stand "Basic"**

stainless steel 18/10 brushed (pipe Ø 3.2 cm), with felt pad at the top (black)

item	Ø in cm	height in cm	PU
8080.04	7	4	2 pcs
8080.08	7	8	2 pcs
8080.16	7	16	2 pcs
8080.24	7	24	2 pcs





The card holder made of stainless steel is available on page 100.

"Basic" is the simple and flexible solution to create different presentation levels. The high-quality columns made of matt brushed stainless steel (18/10) are a fitting base for buffet platters made of glass and other materials. The columns are fitted with felt pads on the top to protect the surface of glass platters and to level out any unevenness of the tables. The feet with 7 cm in diameter guarantee firm standing. The unobtrusive and unadorned design of the buffet stands puts food and drinks into the limelight.

"Basic" is available in four heights and can be combined with several Zieher buffet systems (pages 26). The carbon buffet stands "V12" presented here can be found on pages 28 to 29.

Please note: We do not recommend the use of "Basic" in combination with buffet platters made of natural slate. Due to the slightly varying thickness of natural slate platters, this combination might shake.



"Basic" & "Konkret!"

"Basic" & "V12" Carbon





# "Luxor"

Buffet bowls made of grey glass are available on pages 72 to 77.



The glass tubes of the "Flex" series are available on page 202.



## buffet display "Luxor"

high-quality shell imitation, golden, washable, bottom side open, with 4 resin feet, not dishwasher-safe

item	l x w x h in cm
8221.08	38x38x8
8221.16	38x38x16
8221.24	38x38x24



Buffet platters made of glass are available from page 50 on.



The shimmering displays of the “Luxor” series enchant by the colour play of golden shades in variable nuances. This effect is created by high-quality shell imitations, which are arranged fan-shaped on a fibreglass base in sophisticated handcrafting. The honed and highly polished, multiple sealing with resin (Polyresin), emphasizes the pattern and the pearlescent shine of the gold-coloured discs and provides the surface with a striking depth effect.

The buffet cuboids are available in heights of 8, 16 and 24 cm and are therefore compatible with many other displays of the Zieher system. The 38 cm x 38 cm large bearing surface can be used directly for presentation purposes or as a basis for buffet platters or stairs of various kinds.

“Luxor” adds a touch of extravagance to both the modern and classic ambience, setting extraordinary accents in any environment.





The buffet displays "Classy" are made of translucent material and impress by their fascinating texture, which is reminiscent of Italian marble or alabaster. The precise workmanship of the cubes as well as the silk-matt surface, increase the fancy impression even more.

"Classy" is available in the Zieher system heights of 8, 16 and 24 cm and can therefore be combined in various ways. The open bottom side of the large displays allows an effective illumination by the optionally available LED-lights. With their different light colours, the LED-lights emphasize the appealing look and the interesting marbling of the material.

The small cube has no open underside and thus cannot be illuminated. The advantage of this construction lies in its high functionality. Its dimensions of 24 cm x 16 cm x 8 cm enable a positioning in 3 heights - a clever supplement to the squarish displays.

The baskets of the "Reef" series are available on pages 64 to 67.



It is possible to stage "Classy" with or without lighting, strikingly eye-catching or quite discreetly. Whether unobtrusive and modern or playful and opulent - "Classy" fits perfectly into any ambience!



Closed on all sides, cannot be illuminated.



### buffet display "Classy"

resin, white, alabaster look, not dishwasher-safe, closed on all sides, can be used in any position

item	l x w x h in cm
8231	24x16x8



The LED-lights are available on pages 44 and 45.



Notch for cable  
for LED-light item 8104



**buffet display "Classy"**

resin, white, translucent, alabaster look, not dishwasher-safe, bottom side open, notch for cable on back side

item	l x w x h in cm
8230.08	38x38x8
8230.16	38x38x16
8230.24	38x38x24





# "Solid"



The buffet displays of the "Solid" series are, as all the other items of this series, made of solid walnut wood. They may be used as containers for cutlery or French bread, but they are particularly suitable for the elevation of the "Modul" walnut trays (page 130) or other buffet platters.

The filigree finger joints at the corners testify to precise craftsmanship of the highest quality and guarantee perfect stability!

The displays made of solid wood are visually appealing and fit perfectly into the existing buffet systems "Solid" and "Mercato" (pages 104 to 117).

Please note the care instructions:  
not dishwasher-safe, do not immerse in water!



## buffet display "Solid"

walnut, food-safe sealed, not dishwasher-safe, bottom side open, can be used as a stand or as a container

item	l x w x h in cm	PU
4767.12	12x12x12	2 pcs
4767.24	12x12x24	2 pcs





## “Konkret!” - Distinct design for highest flexibility!

Plain lines, neutral shapes and two different colour variations put your food presentation into focus and offer a maximum of flexibility, while at the same time, using the available space at your buffet most effectively. Maximum reduced shapes in combination with the rough look of concrete – “Konkret!” blends in particularly well with modern architecture. “Less is more” is the motto!

Both variants of the displays (light grey and dark grey) are available in eight sizes.

A real eye-catcher is the double-walled XXL bowl in dark grey colour. The impressive diameter of 100 cm creates space for various drinks or chilled dishes (page 38).



The displays consist of a mixture of fibreglass and stone and therefore offer the deceptively genuine optics of concrete combined with low weight and high stability, which greatly facilitates handling. The puristic flair of that system will be intensified by using glass platters. Those and other variations made of laminated plastic and slate are available on pages 46 to 54.



The XXL bowl “Konkret!” is available on page 38.



# "Konkret!"



## buffet display "Konkret!"

fibreglass/resin, dark grey (concrete look), not dishwasher-safe, splash-proof, hollow inside, bottom side open

item	l x w x h in cm
8200.12D	24x24x12
8200.24D	24x24x24
8200.36D	24x24x36



## buffet display "Konkret!"

fibreglass/resin, dark grey (concrete look), not dishwasher-safe, splash-proof, hollow inside, bottom side open

item	l x w x h in cm	PU
8210.04D	12x12x4	2 pcs
8210.08D	12x12x8	2 pcs
8210.12D	12x12x12	2 pcs
8210.16D	12x12x16	2 pcs
8210.20D	12x12x20	2 pcs



## XXL bowl "Konkret!"

fibreglass/resin, dark grey (concrete look), round, double-walled, not dishwasher-safe, waterproof-coated inside

item	Ø in cm	height in cm
8212.D	100	28

The separating plate is kept in position by a bearing edge integrated in the bowl.

The rechargeable LED-light item 8150 is available on page 45.



## hand pump

highly elastic PVC, 2.5 mm thick, with hose, for easy drainage of melt water, professional quality, vacuum capacity: 10 l/min

item	Ø hose in cm	total length hose in cm
5662	2	250



## buffet/separating platter

hardened glass, 10 mm thick, satined, round, edge polished and deburred, separates ice from melt water

item	Ø in cm
5240.M	60



## rack for XXL bowls

steel, matt black (powder-coated), three-part for self assembly, adjustable feet for firm positioning on most surfaces, for XXL bowl "Konkret!" item 8212.D and XXL glass bowl item 5704

item	l x w x h in cm
8213	70x70x57



### buffet display "Konkret!"

fibreglass/resin, light grey (concrete look), not dishwasher-safe, splash-proof, hollow inside, bottom side open

item	l x w x h in cm
8200.12L	24x24x12
8200.24L	24x24x24
8200.36L	24x24x36



### buffet display "Konkret!"

fibreglass/resin, light grey (concrete look), not dishwasher-safe, splash-proof, hollow inside, bottom side open

item	l x w x h in cm	PU
8210.04L	12x12x4	2 pcs
8210.08L	12x12x8	2 pcs
8210.12L	12x12x12	2 pcs
8210.16L	12x12x16	2 pcs
8210.20L	12x12x20	2 pcs



"Konkret!"

The XXL bowl in dark-grey concrete look inspires by its enormous size and the low weight. In empty state, it can easily be carried by one person. A filigree, but extremely solid stand made of powder-coated steel forms the perfect basis. A round glass plate separates ice from melting water and at the same time creates space for the Zieher rechargeable LED-light (page 45), which allows the illumination of the ice in striking colours. No matter if placed on the buffet table or on the stand - this bowl will leave a permanent impression on your guests!





# "Chiller-Base"



The porcelain bowl "Cave" is available on page 155.



## cooling pack

nylon, black/white, non-toxic cooling gel

item	l x w in cm
5663.20	20x20



Precise recesses on the underside facilitate positioning!



## chiller base/tray

melamine, square, for cooling pack item 5663.20

item	colour	l x w x h in cm
4597.01	black	41x41x3.5
4597.02	white	41x41x3.5



The „Textura“ buffet displays are available on page 12 / 13.

## "Chiller-Base" - just stay cool!

The cooling elements by Zieher are an elegant and simple solution for a quick and flexible installation of chilled platters. They can be arranged either at different heights by using displays or freely positioned on the buffet table.

The flat bowls are available in matt black and white melamine and have been designed specifically for food whose presentation can be extended significantly by cooling.

The puristic form, the compact height of only 35 mm as well as the restrained colouring allow a stylishly discreet integration into numerous buffet constructions. Tailored recesses on the underside of the trays facilitate symmetrical positioning on most Zieher buffet systems. So a harmonious overall picture can be achieved quickly. Unobtrusive rubber buffers in the corners of the "Chiller-Base" ensure a non-slip and secure fit of laid-up platters in sizes starting from 42 x 42 cm (page 50 - 53).

The cooling pads have been tailor-made for the melamine base to provide for an optimal cooling surface by the perfect fit. The pads can optionally be flipped, depending on whether the black top or the white bottom fits into the overall picture more harmoniously. So, they are applicable inconspicuously, even with slightly translucent or satined buffet platters.

The attractive contrast of top and bottom can also be used on the laid table to deliberately set accents. Serving chilled foods becomes a visual highlight. The high-quality case made of black or white nylon fabric looks very noble and yet discreet. It is filled with gel, which remains malleable, even when frozen and thus allows an adaptation to a wide variety of tableware used.



"Skyline", page 16 - 21



"Basic", page 30/31



"Konkret!", page 38/39



"Skyline", page 16 - 21



"Squareline", page 22 - 24





"Antique"



Please note: Due to the density of the material, the glow may be limited.

Notch for cable for LED-light item 8104



**buffet stand "Antique"**

polyresin sandstone mixture, sandy colour, hollow inside, notch for cable on back side

item	Ø in cm	height in cm
8011.12	12.5	12
8011.24	12.5	24
8011.36	12.5	36

"Stablo" page 55 to 59



"Squareline" page 22 to 24



XXL bowl glass page 73



"Konkret!" page 37 to 39



# "Lightning Buffet"

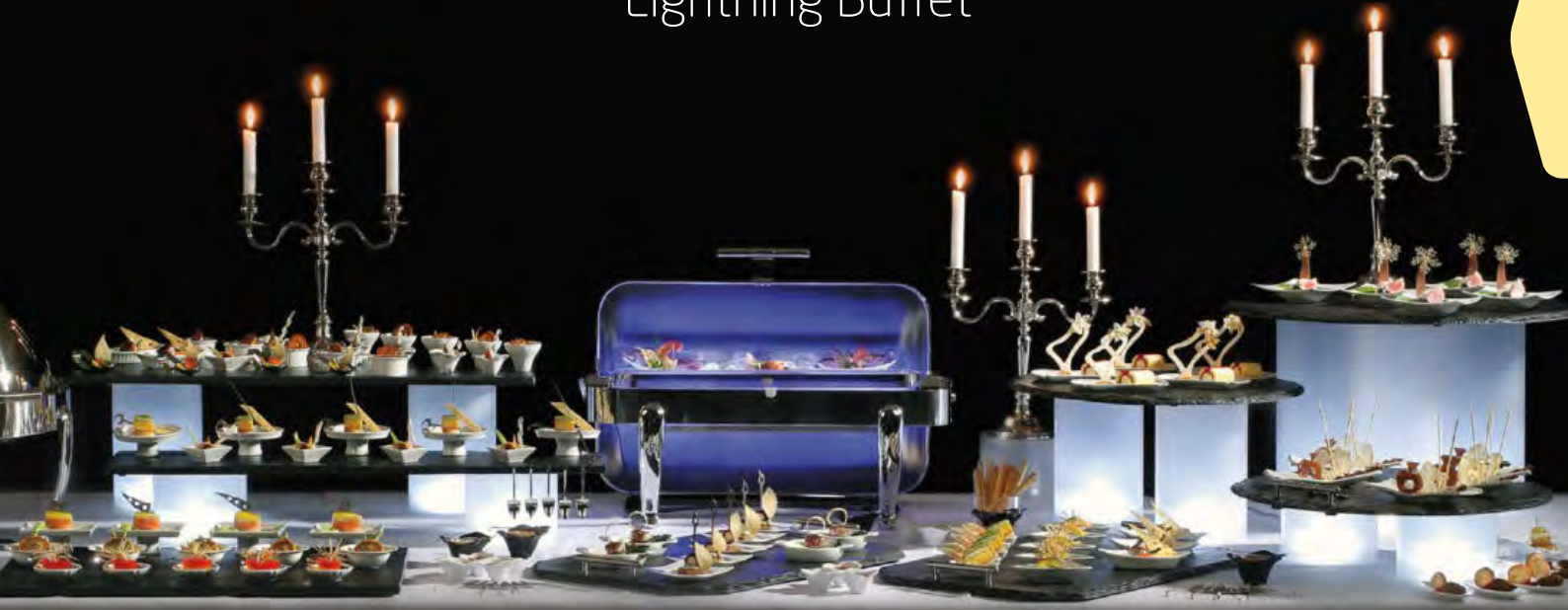

## Bringing light into the darkness!

The illuminated buffet stands, in connection with platters made of natural slate, laminated plastic or glass (pages 46 to 54), make every buffet shine in a radiant new light.

The innovative LED technology does not radiate any heat and is powered by a harmless voltage. It is characterized by its longevity and its low power consumption. The standard light of the cabled LED is white, but thanks to the coloured plastic covers, the colour scale is enlarged to contain red, yellow, green and blue (page 44).

Alternatively, there is a rechargeable LED-light with several different functions available. Besides a fixed colour range and special programs, its particular feature is a remote control that enables changing colours and programs during use. For a detailed description of this LED-light and its functions, please check out page 45.

The columns made of satined acrylic (page 44) are available in seven sizes and feature a removable cover to enable the insertion of round bowls.

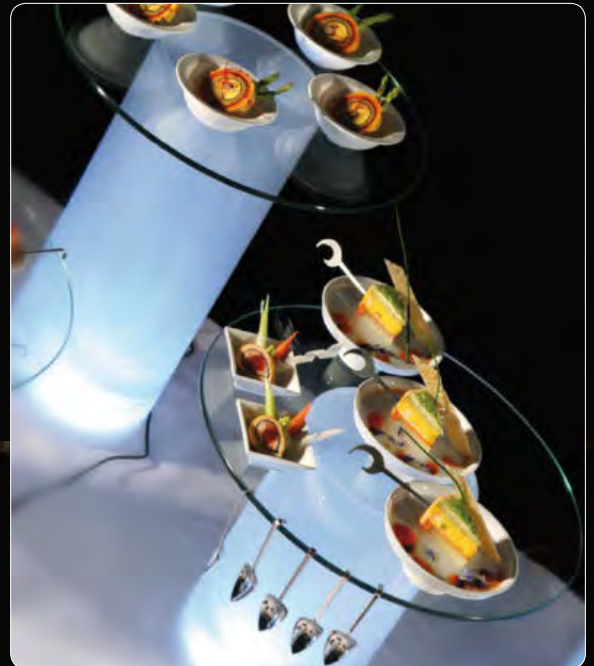



## LED-light with cable, item 8104...



For permanently installed buffets which are not dismantled on a daily basis, it is recommended to use the LED-light with cable item 8104.

The standard light is white; the alternative colours blue, yellow, green and red can be chosen by using the precisely fitting plastic covers items 8105... (available as accessories).

A set consists of 3 lights and the matching power supply, which can be fitted with a total of 6 lights. All cables are white and the power cable of the light has a length of 3 metres, which is enough to stow away adapter and power supply safely and invisibly under the buffet table.



### LED-light

white light, set of 3 LED-lights including power supply (cable), sixfold junction for up to 6 lights, 100-240 V, 50/60 Hz, Ø 9.7 cm, 2 cm high

item	power plug
8104	Europe
8104.UK	UK
8104.USA	USA

Please note: The luminosity depends on the spatial realities; the actual colouring may deviate from the colours shown in the pictures!



### colour cover

plastic, for LED-light items 8104..., Ø 10 cm

item	colour	PU
8105.01	blue	3pcs
8105.02	yellow	3pcs
8105.03	green	3pcs
8105.04	red	3pcs



### acrylic glass tube

satined (white), removable lid for easy fitting of bowls etc., notch for cable for LED-light item 8104 (not included, please order separately)

item	Ø in cm	height in cm	PU
8122.10	12	10	3 tubes
8122.22	12	22	3 tubes
8122.34	12	34	3 tubes
8122.58	12	58	3 tubes



### acrylic glass tube

satined, white, removable lid for easy fitting of bowls etc., notch for cable for LED-light item 8104 (not included in delivery, please order separately)

item	Ø in cm	height in cm	PU
8120.01	15	12	3 tubes
8120.02	15	24	3 tubes
8120.03	15	36	3 tubes

The height of the columns items 8122... have been adjusted especially for the illumination of the "Skyline" buffet system. The lids of all acrylic glass tubes are removable. Therefore the tubes can also function as supports for plates, bowls, etc.

## Rechargeable LED-light with radio remote control:

The compact LED-light is controlled by remote control, which allows for a more flexible use of the Zieher "Lightning Buffet" and renders it independent from any power supply and spatial requirement.

This creates a lot of new possibilities for the buffet set-up: out in the open, next to the pool or in the middle of the room – without any troublesome cables and controllers that might get into the guests' or the personnel's way.

The necessary radio remote control item 8151 (to be ordered separately) rounds off the whole system in regard to function and handling and allows to choose the colouring within a range of up to 15 m without dismantling the buffet first. Due to many different colours and special programs, the buffet will fit into every kind of atmosphere. The lighting colour for the complete buffet can be changed by pressing only one button.

- 7 fixed colours and 3 special programs, manageable via remote control (white, green, red, blue, yellow, violet, turquoise, flickering-candle-effect, colour change, colour gradient)
- 3 different brightness-settings selectable (100 % - 70 % - 50 %, only adjustable directly)
- Fixedly integrated high-performance batteries guarantee a running-time of up to 20 hrs (at the lowest brightness-setting)
- LED-light waterproof up to a depth of 1 mtr.
- Remote control (to be ordered separately) controls up to 20 LED-lights simultaneously / range up to 15 m
- Charging device can be mounted on a wall and features a space-saving cable spool



Waterproof up to a depth of 1 metre!



Experience the "Lightning Buffet" - no matter where - you will be excited!



### rechargeable LED-light

remote-controlled, 3 different degrees of brightness (only selectable on the light directly), 7 fixed colours (white, green, red, blue, yellow, violet, turquoise) and additionally: candle flickering, colour gradient and colour change (only selectable by remote control item 8151, please order separately)

item	Ø in cm	height in cm
8150	9.5	3



### remote control

for rechargeable LED-light item 8150, white with grey cord

item	l x w x h in cm
8151	8.5x5.2x2.8

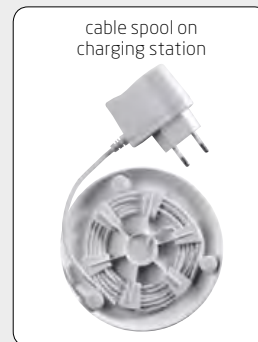
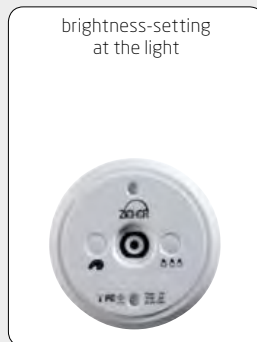
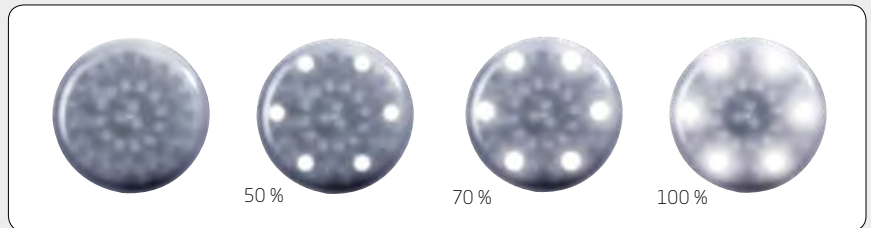

### charging device for rechargeable LED-light

white, with handy cable spool (1.5 m of cable), wall fixing possible, 3 anti-slip rubberfeet, Ø 13 cm, 2 cm high

item	power plug
8152.EU	Europe
8152.UK	UK
8152.US	USA



The entire instruction sheet with a detailed description of all functions is available at [https://www.zieher.com/fileadmin/ZieherUploads/Bedienungsanleitungen/Bedienungsanleitung\\_Akku\\_LED\\_Leuchte\\_\\_8150\\_.pdf](https://www.zieher.com/fileadmin/ZieherUploads/Bedienungsanleitungen/Bedienungsanleitung_Akku_LED_Leuchte__8150_.pdf)

Please note: The luminosity depends on the spatial realities; the actual colouring may deviate from the colours shown in the pictures!





# Buffet platters and more!

Zieher is offering a wide range of buffet platters made of laminated plastic, several kinds of glass and natural slate. Due to the wide choice of formats and types of materials, there are many possibilities of combinations with Zieher's buffet systems (pages 10 to 43). The offer is being completed by various buffet stairs, trays and bowls (pages 54 to 88).

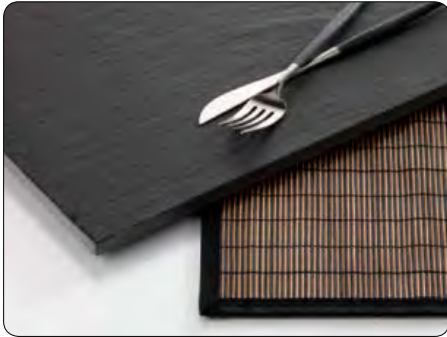

Natural slate, page 47

- Food-safe sealed/unsealed
- 10 - 15 mm thick
- With rubber feet



Laminated plastic, page 48

- Dark grey, black intermediate ply
- 8 mm thick
- Break-proof
- Dishwasher-safe
- Scratch-proof
- Antistatic



Laminated plastic, page 49

- Matured wood look, white or rusted look, black intermediate ply
- 8 mm thick
- Break-proof
- Dishwasher-safe
- Scratch-proof
- Antistatic



Black glass, page 50

- Specially hardened safety glass
- 4 mm thick, low weight
- Edges polished and rounded
- Underside scratch-resistant, black
- Shock-proof, heat-resistant
- Dishwasher-safe



White glass, page 51

- Special hardened safety glass
- 4 mm thick, low weight
- Edges rounded and polished
- Underside scratch-resistant, white
- Shock-proof, heat-resistant
- Dishwasher-safe

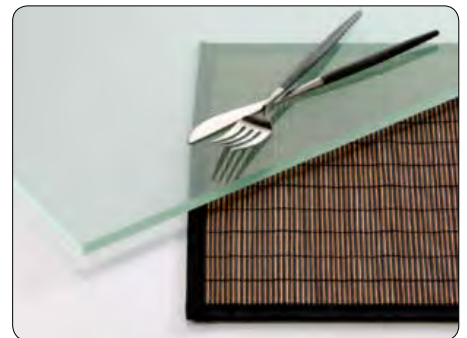

Satin glass, page 52

- Specially hardened safety glass
- 10 mm thick
- Edges polished and deburred
- Underside satin
- Dishwasher-safe

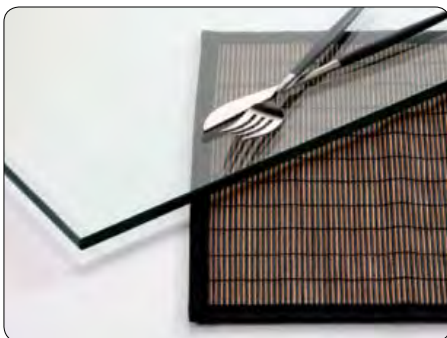

Transparent glass, page 52

- Specially hardened safety glass
- 10 mm thick
- Edges polished and deburred
- Dishwasher-safe

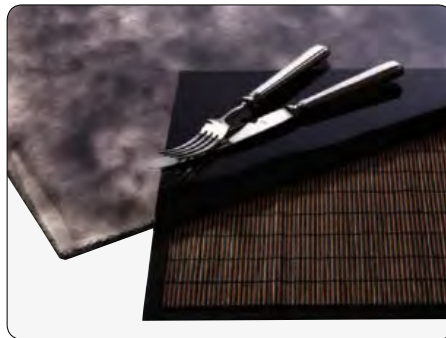

Structured glass, page 53

- Special hardened safety glass
- 5 or 8 mm thick (depending on size)
- Edges rounded
- Underside structured
- Irregular colouring in cloudy optic
- Dishwasher-safe



Dark grey glass, page 53

- Specially hardened safety glass
- 10 mm thick, transparent
- Edges polished and deburred
- Dishwasher-safe



# Buffet platters made of slate!

- Natural slate
- Food-safe sealed/unsealed
- 10 to 15 mm thick
- With rubber feet



## charger plate, slate

natural slate, approx. 5 mm thick, food-safe (sealed), not dishwasher-safe, with rubber feet

item	version	l x w in cm
2543.30	square	30 x 30
2544.30	rectangular	30 x 20



## buffet platter 1/1 GN, slate

natural slate, 10 to 15 mm thick, unsealed, not dishwasher-safe, rectangular, with rubber feet

item	l x b in cm
8020	53x32.5

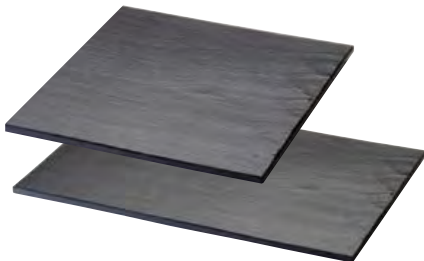

## buffet platter, slate

natural slate, 10 to 15 mm thick, food-safe (sealed), not dishwasher-safe, with rubber feet

item	version	l x w in cm
8005.01	square	50x50
8005.02	rectangular	50x42
8005.04	square	42x42
8005.05	rectangular	42x34
8005.06	square	34x34
8005.07	rectangular	60x40



## buffet platter, slate

natural slate, 10 to 15 mm thick, food-safe (sealed), not dishwasher-safe, round, with rubber feet

item	Ø in cm
8005.21	60

Slate is a unique and exceptional natural product. The surfaces of our slate plates have the typical cleavage. Every piece is unique. Small deviations in structure, thickness (10 to 15 mm) and weight of the platters cannot be avoided, as it is in the nature of the product. Also, there could be single inclusions of other minerals and fossils. These exceptional features give slate its precious and vivid appearance. Please note: Specific groceries, especially those that contain fruit acid (citric acid) may damage the surface in case of prolonged contact. Therefore we recommend avoiding any direct contact with edibles.





# Buffet platters made of laminated plastic!

- Dark grey, black intermediate ply
- 8 mm thick
- Break-proof
- Dishwasher-safe
- Scratch-proof, antistatic



The buffet-stands "StiXXX" made of laminated plastic are available on page 27.



The "Amuse" series is available on pages 206 to 208.



## buffet platter, laminated plastic

laminated plastic, 8 mm thick, dark grey, black intermediate ply, break-proof, scratch-proof, dishwasher-safe, antistatic, deburred edges, rounded corners

item	version	l x w in cm
8006.01	square	50x50
8006.02	rectangular	50x42
8006.04	square	42x42
8006.06	square	34x34
8006.08	rectangular	80x21
8006.11	1/1 GN	53x32.5
8006.13	rectangular	95.4x39
8006.14	rectangular	91x21
8006.15	rectangular	102x21

The buffet stands "Basic" are available on page 30, "Konkret!" on pages 37 to 39.



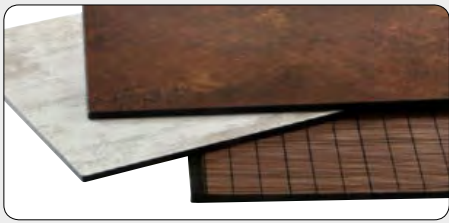

# Buffet platters made of laminated plastic!

- Matured wood look, white / rusted look, black intermediate ply
- 8 mm thick
- Break-proof
- Dishwasher-safe
- Scratch-proof, antistatic



## buffet platters "Vintage"

laminated plastic, 8 mm thick, matured wood look, white, black intermediate ply, break-proof, scratch-proof, dishwasher-safe, antistatic, deburred edges, rounded corners

item	version	l x w in cm
8001.01	square	50x50
8001.02	rectangular	50x42
8001.04	square	42x42
8001.06	square	34x34
8001.08	rectangular	80x21
8001.11	1/1 GN	53x32.5
8001.13	rectangular	95.4x39

## The charm of transience

Break- and scratch-resistant, anti-static and dishwasher-safe - these features of laminated plastic platters and the resulting advantages are convincing!

The buffet platters made of laminated plastic are available in a neutral, dark grey version as well as in two extraordinary variations. The antique white "Vintage" decor is reminiscent of weathered and white, discoloured old timber planks. It emphasizes the radiance of imperfection and perfectly fits the furnishings of the attractive country style.

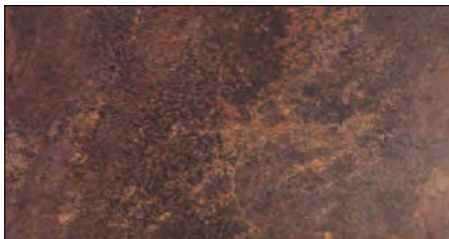

Unplastered brick-lined walls, load-bearing structural elements made of steel beams, exposed concrete and the morbid charms of abandoned factory buildings create the ambience for the rust-coloured decoration "Industry 2.0". This is evocative of weathered steel surfaces, which are marked by decades of corrosion and fits perfectly into the industrial style of modern architecture.

All laminated buffet platters by Zieher have a dark middle layer and can be used on both sides because they are double-coated.

## buffet platter "Industry 2.0"

laminated plastic, 8 mm thick, rusted look, black intermediate ply, break-proof, scratch-proof, dishwasher-safe, antistatic, deburred edges, rounded corners

item	version	l x w in cm
8007.01	square	50x50
8007.02	rectangular	50x42
8007.04	square	42x42
8007.06	square	34x34
8007.08	rectangular	80x21
8007.11	1/1 GN	53x32.5
8007.13	rectangular	95.4x39

All information about the displays of the "Crossline" series can be found on pages 14/15.



Please note: With these decors, each plate is unique - none of them look alike.



# Buffet platters made of black glass!

- Special hardened safety glass
- 4 mm thick, low weight
- Edges rounded and polished
- Underside scratch-resistant, black
- Shock-proof, heat-resistant, dishwasher-safe



## buffet platter, black glass

special hardened safety glass, 4 mm thick, black, rounded edges, polished rim, dishwasher-safe, rubber feet included (adhesive), underside scratch-proof

item	version	l x w in cm
1668.01	square	50x50
1668.03	rectangular	50x34
1668.04	square	42x42
1668.05	rectangular	42x34
1668.06	square	34x34
1668.08	rectangular	80x21
1668.09	rectangular	80x40
1668.10	rectangular	30x18
1668.12	rectangular	66x10

NEW



## buffet platter, black glass

special hardened safety glass, 4 mm thick, with 2 concave cutouts, rounded edges, polished rim, dishwasher-safe, rubber feet included (adhesive), underside scratch-proof

item	l x w in cm
1668.20	49x21

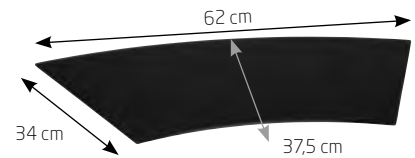

## buffet platter Curve 45°

special hardened safety glass, 4 mm thick, curved shape, rounded edges, polished rim, dishwasher-safe, rubber feet included (adhesive), underside scratch-proof

item	l x w in cm	PU
1668.14	62x37,5	2 pcs

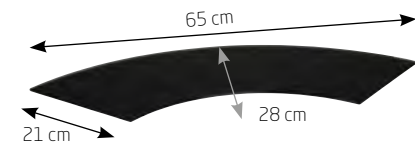

## buffet platter Curve 90°

special hardened safety glass, 4 mm thick, curved shape, rounded edges, polished rim, dishwasher-safe, with rubber feet included (adhesive), underside scratch-proof

item	l x w in cm	PU
1668.15	65x28	2 pcs



## buffet platter, black glass

special hardened safety glass, 4 mm thick, black, round, edges polished, dishwasher-safe, with rubber feet (adhesive), underside scratch-proof

item	Ø in cm
1669.33	33
1669.53	53



# Buffet platters made of white glass!

- Special hardened safety glass
- 4 mm thick, low weight
- Edges rounded and polished
- Underside scratch-resistant, white
- Shock-proof, heat-resistant, dishwasher-safe



## buffet platter, white glass

special hardened safety glass, 4 mm thick, white, rounded edges, polished rim, dishwasher-safe, rubber feet included (adhesive), underside scratch-proof

item	version	l x w in cm
1670.01	square	50x50
1670.03	rectangular	50x34
1670.04	square	42x42
1670.06	square	34x34
1670.08	rectangular	80x21
1670.09	rectangular	80x40
1670.10	rectangular	30x18
1670.12	rectangular	66x10



## buffet platter, white glass

special hardened safety glass, 4 mm thick, with 2 concave cutouts, rounded edges, polished rim, dishwasher-safe, rubber feet included (adhesive), underside scratch-proof

item	l x w in cm
1670.20	49x21

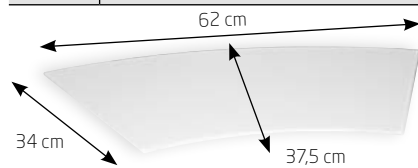

## buffet platter Curve 45°

special hardened safety glass, 4 mm thick, white, curved shape, rounded edges, polished rim, dishwasher-safe, rubber feet included (adhesive), underside scratch-proof

item	l x w in cm	PU
1670.14	62x37.5	2 pcs

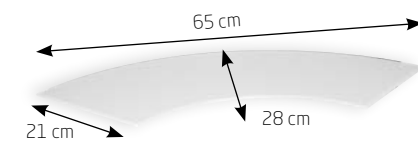

## buffet platter Curve 90°

special hardened safety glass, 4 mm thick, white, curved shape, rounded edges, polished rim, dishwasher-safe, rubber feet included (adhesive), underside scratch-proof

item	l x w in cm	PU
1670.15	65x28	2 pcs



## buffet platter, white glass

special hardened safety glass, 4 mm thick, white, round, edges polished, dishwasher-safe, with rubber feet (adhesive), underside scratch-proof

item	Ø in cm
1671.33	33
1671.53	53

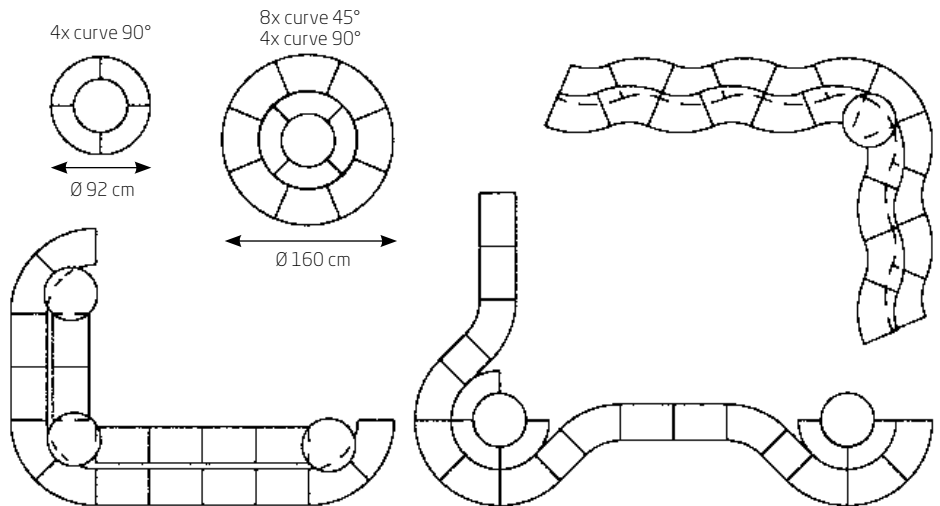

The curved platters combined with compatible buffet platters and buffet stands allow innumerable variations! These platters are available in black glass (page 50), white glass (page 51) and transparent glass (page 52).





## Buffet platters made of satined glass!

- Special hardened safety glass
- 10 mm thick
- Edges polished and deburred
- Underside satined
- Dishwasher-safe

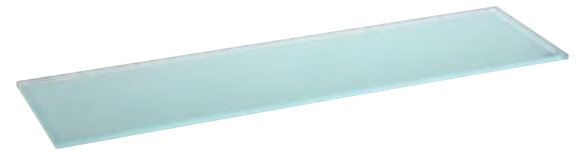
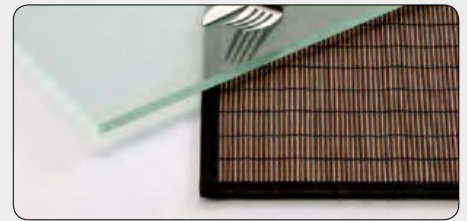

### buffet platter, satined glass

hardened glass, 10 mm thick, satined, edges polished and deburred

item	version	l x w in cm
5243.M	rectangular	80x21



### buffet platter, satined glass

hardened glass, 10 mm thick, satined, round, edges polished and deburred

item	Ø in cm
5240.M	60

## Buffet platters made of transparent glass!

- Special hardened safety glass
- 10 mm thick
- Edges polished and deburred
- Dishwasher-safe

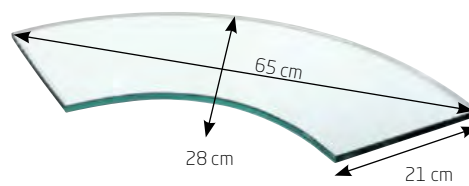

### buffet platter Curve 90°

hardened clear glass, 10 mm thick, curved shape, edges polished and deburred

item	l x w in cm	PU
5241	65x28	2 pcs

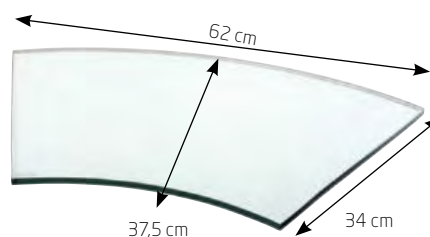

### buffet platter Curve 45°

hardened clear glass, 10 mm thick, curved shape, edges polished and deburred

item	l x w in cm
5242	62x37.5

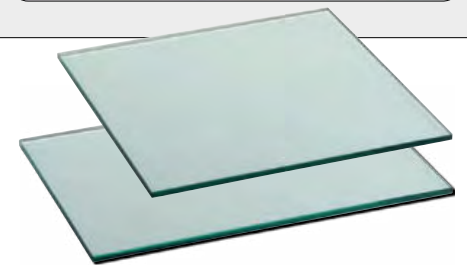

### buffet platter, clear glass

hardened glass, 10 mm thick, edges polished and deburred

item	version	l x w in cm
8004.01	square	50x50
8004.02	rectangular	50x42
8004.03	rectangular	50x34
8004.04	square	42x42
8004.05	rectangular	42x34
8004.06	square	34x34
5243	rectangular	80x21
5000	rectangular	95.4x39



### charger plate/glass insert

hardened clear glass, 6 mm thick, round, edge polished and deburred, for serving tray "Solid" item 4710

item	Ø in cm
4999	33



## Buffet platters made of structured glass!

- Special hardened safety glass
- 5 or 8 mm thick (depending on size)
- Edges rounded, underside structured
- Irregular colouring in cloudy optic
- Dishwasher-safe

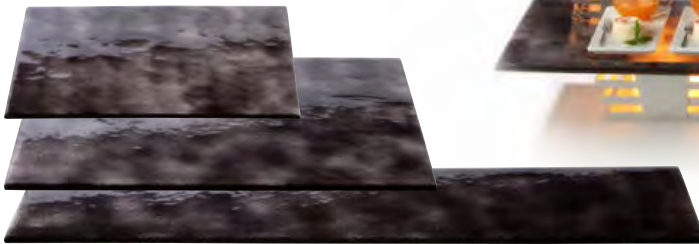

### buffet platter

hardened glass, grey transparent, irregularly coloured in a cloudy look, underside structured, dishwasher-safe, scratch-proof

item	version	l x w in cm	thickness in mm
8008.01	square	50x50	8
8008.02	rectangular	50x42	8
8008.03	rectangular	50x34	8
8008.04	square	42x42	5
8008.05	rectangular	42x34	5
8008.06	square	34x34	5
8008.07	2/1 GN	65x53	8
8008.08	rectangular	80x21	8
8008.13	rectangular	95.4x39	8

### Each piece is unique!

The irregular colouring of the Zieher buffet platters is created by colour pigments, which are manually applied and fused into the glass. The colour is fixed inside the glass and therefore dishwasher-safe and abrasion resistant. Structured underside and rounded edges emphasize the effect of the platters and the individual and interesting shades of grey and intensity of colour create unique patterns in each platter!

The creamer is available on page 208.



## Buffet platter made of dark grey glass!

- Special hardened safety glass
- 10 mm thick
- Edges polished and deburred
- Dark grey, transparent
- Dishwasher-safe



### buffet platter, dark grey glass

hardened glass, 10 mm thick, dark grey, edges polished and deburred

item	version	l x w in cm
8004.07B	2/1 GN	65x53

The tray stand "Solid" is available on page 272.





# Glass steps and more!

The buffet system "Skyline" is available on pages 16 to 21.



## glass steps

deep black 5026.03: 32 cm long, 34 cm wide (horizontal position) 5026.04: 55 cm long, 42 cm wide (horizontal position)

item	l x w x h in cm (glass step)	thickness in mm
5026.03	32x34x3.5	6
5026.04	55x42x4	8



The glass steps items 5026... are adjusted to the Zieher system and due to their height of 12 resp. 24 cm can easily be combined with many Zieher buffet raisers (page 26). Miniatures made of black glass are available on page 234.



## glass tray

glass, deep black, rectangular, for buffet or flying buffet, also functions as a tray

item	l x w x h in cm
5141.34	34x18x2
5141.50	51x35x2



## glass tray

glass, deep black, square, for buffet or flying buffet, functions as a tray or as a charger plate

item	l x w x h in cm
5142.34	35x35x2



## glass steps

5026.01: 32 cm long, 34 cm wide (horizontal position) 5026.02: 55 cm long, 42 cm wide (horizontal position)

item	l x w x h in cm (glass step)	thickness in mm
5026.01	32x34x3.5	6
5026.02	55x42x4	8



## glass steps

wavy, 7 steps, delivered in a wooden box, horizontal length: 67 cm/vertical length: 65 cm

item	version	width in cm
5076.01	clear	40

Delivery of all big glass steps in a solid wooden box!

"Stablo"





## “Stablo”- filigree versatility!

The buffet stands made of solid, brightly polished stainless steel impress by their high-quality workmanship and delicate appearance. Bowls and dishes appear almost hovering while slip-proof caps on the feet ensure safe support. The height of the stand (item 8016.01) is adjustable via extensions from 80 cm to 120 cm. Massive and bulky buffet tables become virtually redundant.

The buffet stand with its integrated ring (item 8016.01), allows for the presentation of plates and platters (max. dia. 21 cm on the lower level), but also for the insertion of extravagant wine coolers made of borosilicate glass. The coolers, positioned at an angle, may also be used with the “Stablo” stands in the sizes M and L.

The shape of the cooler corresponds to the already well-known Zieher glass cloches (pages 173 to 176), thicker quality borosilicate glass ensure the necessary stability! Due to its shape, any condensing water on the outside is drained off to the bottom tip. Dripping water can easily be caught by placing a small bowl on the floor or the buffet table. The integration of the optionally available Zieher rechargeable LED-lights creates breathtaking visual effects and puts champagne but also iced food in the limelight!



A three-staged buffet etagere is offering a lot of space for all kinds of food. It can be equipped with numerous trays and plates of the Zieher range. Anti-slip caps avoid annoying noise and ensure the safe grip of the trays.



Design: Uwe Kopp, Jörg Stricker

The etagere with suitable trays is available on pages 58 und 59.



### buffet stand "Stablo" S, M, L

massive stainless steel 18/10, polished, 10 mm thick, with 6 anti-slip rubber caps

item	Ø upper/lower in cm	height in cm	PU
8015.20	22/30	20 / S	3 pcs
8015.30	22/35	30 / M	3 pcs
8015.40	22/39	40 / L	3 pcs



### buffet stand "Stablo"

massive stainless steel 18/10, polished, 8 mm thick, with 6 anti-slip rubber caps

item	Ø upper/lower in cm	height in cm	PU
8014.13	15/20.5	13.5	3 pcs
8014.20	15/23	20	33

The rechargeable LED-light item 8150 and suitable accessories are available on page 45.



Instruction sheet with detailed description: [https://www.zieher.com/fileadmin/ZieherUploads/Bedienungsanleitungen/Bedienungsanleitung\\_Akku\\_LED\\_8150.pdf](https://www.zieher.com/fileadmin/ZieherUploads/Bedienungsanleitungen/Bedienungsanleitung_Akku_LED_8150.pdf)



By positioning the cooler at an angle it is also suitable for buffet stands "Stablo" M and L.



Also available separately!

### buffet stand "Stablo" XL-ring

massive stainless steel 18/10, polished, 12 mm thick, with ring-opening (Ø 12 cm inside) for wine cooler items 4881.26, with 6 anti-slip rubber caps, 3 of which are separately packed (to clip onto the bottom part while not using the extensions items 8017..., please order the extensions separately)

item	Ø upper/lower in cm	height in cm	PU
8016.01	22.5/37	40	3 pcs



### wine cooler

borosilicate glass, transparent, handblown, handmade, reinforced version, for "Stablo" M, L items 8015.30 and 8015.40 (by positioning the cooler at an angle) and "Stablo" XL ring item 8016.01

item	Ø in cm	height in cm
4881.26	26	approx. 43



Positioning of ring and light



### Ring „SelectionA.“

Silikon, Ø 8,3 cm

item	colour	PU
4681.S	black	6 pcs
4681.W	white	6 pcs



### extension "Stablo"

massive stainless steel 18/10, polished, 12 mm thick, with anti-slip rubber caps, for buffet stand "Stablo" item 8016.01 (not suitable for items 8014... and 8015...)

item	length in cm	PU
801740	40	1 set (3 parts)
801760	60	1 set (3 parts)
801780	80	1 set (3 parts)

### Extension for buffet stand XL ring

801740: for a total height of 80 cm  
801760: for a total height of 100 cm  
801780: for a total height of 120 cm  
Please note: For one buffet stand "Stablo" XL ring item 8016.01 only one set of extensions is required.



Including 60 cm extensions.



### illuminated wine cooler with stand: gift set "Stablo"

Set consists of:

**wine cooler** made of borosilicate glass  
**rechargeable LED-light** incl. charging device, remote control and silicone ring to place the light on  
**stand "Stablo" XL-ring** made of massive stainless steel 18/10, polished, with anti-slip rubber caps, incl. extension set with 60 cm length, 1 set in black gift box

item	height in cm	PU
8070.01PB	52/112	1 set (7 parts)







The buffet etagere item 2193.02 in hammered look is available on page 99.



### base tray "Modul"

melamine, black, surface matt, food-safe, dishwasher-safe, not suitable for microwave and combi steam oven

item	l x w x h in cm	PU
4582	72.5x28x1.8	2 pcs



### base tray "Modul"

walnut, food-safe sealed, not dishwasher-safe, stackable

item	l x w x h in cm
4722	70x25.5x3.1



### buffet platter

special hardened safety glass, 4 mm thick, rectangular, rounded edges, polished rim, dishwasher-safe, rubber feet included (adhesive), underside scratch-proof

item	version	l x w in cm
1668.08	black glass	80x21
1670.08	white glass	80x21



### buffet platter

hardened glass, 10 mm thick, rectangular, edges polished and deburred

item	version	l x w in cm
5243	transparent glass	80x21
5243.M	satined glass	80x21



### buffet platter

hardened glass, grey transparent, rectangular, irregularly coloured in a cloudy look, underside structured, dishwasher-safe, scratch-proof

item	l x w in cm	strength in mm
8008.08	80x21	8



### buffet platter

laminated plastic, 8 mm thick, rectangular, black intermediate ply, break-proof, scratch-proof, dishwasher-safe, antistatic, deburred edges, rounded corners

item	version	l x w in cm
8001.08	matured wood look, white	80x21
8007.08	rusted look	80x21
8006.08	dark grey	80x21



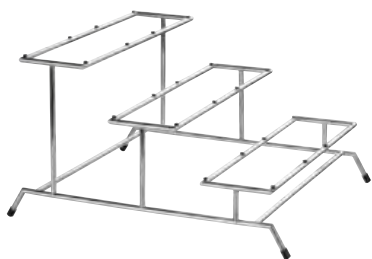

**buffet etagere "Stablo"**

massive stainless steel 18/10, 10 mm thick, with 4 anti-slip rubber caps and 24 rubber pads (for anti-slip placing of the trays), support for trays: 46.5 cm x 13 cm

item	l x w x h in cm
8013	46.5x54.5x30



**tray**

massive stainless steel 18/10, rectangular, hammered finish, six times polished, for buffet etagere items 2193, 2193.02 and 8013

item	l x w x h in cm
2193.01	62x18x5



**glass tray**

glass, satined, rectangular

item	l x w x h in cm
5160.31	31x21x3.5
5160.62	62x21x3.5



**glass tray**

glass, dark grey, rectangular

item	l x w x h in cm
5161.31	31x21x3.5
5161.62	62x21x3.5





"Shine", page 62



"Splash", page 63



"Reef", page 64 to 67



"Fakir", "Roots", "Matrix", page 69



"Unique", page 70



"Capiz", page 71



XXL Bowl, page 73



"Cave", page 76



"Duplex", page 76



"Medusa", page 81



"Art de Buffet", page 82 to 88



"Solid", page 104 to 119



## Buffet bowls





# Thermo-bowls "Shine"



The stainless steel bowls of the "Shine" series are double-walled and therefore have an isolating effect. This helps to prevent water condensation - even at elevated temperatures. Cold food stays cold and warm food stays warm longer.



The slim top edge appears elegant and filigree. The accentuated contrast between the highly polished outside and the unobtrusive finish on the inside (fine brushed stainless steel, ivory or taupe coloured) makes that series an eye-catcher. "Shine" is the perfect combination of elegance and subtlety. It is easily changeable to achieve a variation of presentations and it is effective due to its double-walled construction.



satined



## bowl "Shine"

stainless steel 18/10, outside polished, inside satined, double-walled, round/oblique, dishwasher-safe

item	Ø in cm	height in cm	content in l
2260.16	15.7	6.7 / 8.8	0.5
2260.20	19.7	8.5 / 11	0.9
2260.24	23.7	10 / 13	1.6



ivory



## bowl "Shine"

stainless steel 18/10, outside polished, double-walled, round/oblique, food-safe coating inside (colour: ivory, not dishwasher-safe)

item	Ø in cm	height in cm	content in l
2261.16	15.7	6.7 / 8.8	0.5
2261.20	19.7	8.5 / 11	0.9
2261.24	23.7	10 / 13	1.6

## bowl "Shine"

in black gift box

item	Ø in cm	height in cm	content in l
2261.16PB	15.7	6.7 / 8.8	0.5
2261.20PB	19.7	8.5 / 11	0.9
2261.24PB	23.7	10 / 13	1.6



taupe



## bowl "Shine"

stainless steel 18/10, outside polished, double-walled, round/oblique, food-safe coating inside (colour: taupe, not dishwasher-safe)

item	Ø in cm	height in cm	content in l
2262.16	15.7	6.7 / 8.8	0.5
2262.20	19.7	8.5 / 11	0.9
2262.24	23.7	10 / 13	1.6

Please note:

When cleaning the coated bowls (ivory and taupe coloured) in the dishwasher, the coating at the rim might abrade in the course of time. Therefore it is recommended to clean these items by hand.

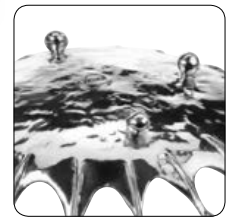

**bowl "Splash"**

pewter, hammered finish, polished, round, flat, food-safe, not dishwasher-safe, with supporting feet

item	Ø/height in cm	inside usable area Ø in cm
2340.15	15/5	6
2340.22	22.5/5.5	13
2340.28	28/6.5	19
2340.38	38/8	29

**bowl "Splash"**

in black gift box

item	Ø/height in cm	inside usable area Ø in cm
2340.15PB	15/5	6
2340.22PB	22.5/5.5	13
2340.28PB	28/6.5	19

**The "Splash" - effect**

Dynamics of movement – solidified to a statue! The bowls of the "Splash" series spread a very special flair by their playful optics. Whether used as fruit bowl in the big, for amuse gueule, culinary delights in the small or as decorative deposit place in all varieties, "Splash" sets a charming course at the table and for interiors. The bowls are made of solid pewter, manually assembled of numerous single components and elaborately refined. Knobbed feet at the bottom side guarantee a safe stand.





# "Reef"

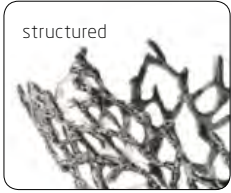

The projecting XXL bowl combines filigree structures with impressive dimensions. Made of premium pewter, countless fine ramifications combine to form a beautiful whole and thus provide necessary stability with low weight at the same time.

This design gives an unobstructed view of the contents of the bowl and forms a precious frame to stage particularly fruit or other delicacies in an extravagant way. The surface of the bowl is polished on the inside, while on the outside, it impresses with its coral-like structure.



## bowl/basket "Reef"

pewter, structured and patinated outside, oval, food-safe, not dishwasher-safe

item	l x w x h in cm
2332	20x10x12



## bowl/basket "Reef"

pewter, structured and patinated outside, round, food-safe, not dishwasher-safe

item	Ø in cm	height in cm
2334	33	14



## bowl/basket "Reef"

pewter, structured and patinated outside, food-safe, not dishwasher-safe, with supporting feet

item	w x d x h in cm
2335	54x18x66



## bowl/basket "Reef"

pewter, structured and patinated outside, food-safe, not dishwasher-safe, with supporting feet

item	l x w x h in cm
2336	75x10x14

## bowl/basket "Reef"

in black gift box

item	l x w x h in cm
2336.PB	75x10x14

NEW



## bowl/basket "Reef"

pewter, structured and patinated outside, food-safe, not dishwasher-safe, with supporting feet

item	l x w x h in cm
2337	100x24x30



# "Reef"

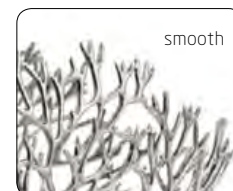

Large numbers of single parts are casted from premium pewter and subsequently assembled in high-grade craftsmanship to give shape to these items. The inimitable pieces of art created that way are unique items, which inspire by the polished surface of the organic structures and the rounded tails of the meshwork. The products of the "Reef" series are genuine gems of dining culture! Whether there are bowls filled with bread or fruit in the focus of attention, high-quality textiles held together by extravagant napkin rings emphasizing the ambiance, or the delightful shadow play of candlelight creating an atmospheric ambiance - "Reef" turns any table into a fine dining experience.

## bowl/basket "Reef"

pewter, surface smooth, food-safe, not dishwasher-safe, with feet

item	l x w x h in cm
2314.01	approx. 15x9x24
2314.02	approx. 21x12.5x33
2314.03	approx. 37x18.5x52

## bowl/basket "Reef"

in black gift box

item	l x w x h in cm	📦
2314.01PB	approx. 15x9x24	📦
2314.02PB	approx. 21x12.5x33	📦
2314.03PB	approx. 37x18.5x52	📦

Used as storage space for jewellery or standing on its own as a decorative sculpture, even off the table, the bowls find their application. Even carefully draped towels are also exquisitely presented in the bathroom or in the wellness area. The outside texture of the bowls differs within the series: whether smoothly rounded (page 65 to 67) or roughly structured with dark, patinated deepenings (page 64) - each variant has its own charm!



## bowl/basket "Reef"

pewter, smooth outside, round, high, food-safe, not dishwasher-safe

item	Ø in cm	height in cm
2312.01	36	45
2312.02	23	36



## bowl/basket "Reef"

pewter, smooth outside, oval, food-safe, not dishwasher-safe

item	l x w x h in cm
2313.01	46x19x20
2313.02	32x13x13





# "Reef"



The glass platter is available on page 50, the "Flex" series on page 202.

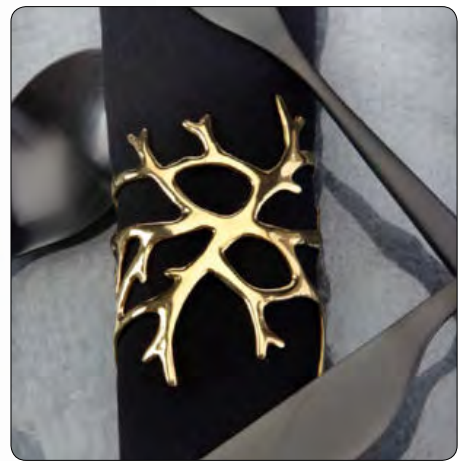

NEW

## napkin ring "Reef"

pewter, real gold coated (18 ct), surface smooth, food-safe, not dishwasher-safe

item	Ø in cm	length in cm	PU
Z317.G	5.5x3.5	7.5	2 pcs

## napkin ring "Reef"

in black gift box

item	Ø in cm	length in cm	PU
Z317.GPB	5.5x3.5	7.5	2 pcs 



## napkin ring "Reef"

pewter, surface smooth, food-safe, not dishwasher-safe

item	Ø in cm	length in cm	PU
Z317	5.5x3.5	7.5	2 pcs

## napkin ring "Reef"

in black gift box

item	Ø in cm	length in cm	PU
Z317.PB	5.5x3.5	7.5	2 pcs 

For tealights or candles up to a height of 10 cm and a diameter of 7 cm.



## wind light

borosilicate glass, satined inside, open at the top and the bottom, for wind light "Solid" item 4700.01 and 4716

item	Ø in cm	height in cm	PU
4991.02	9	14.5	6 pcs

## candle holder/wind light "Reef"

pewter, surface smooth, food-safe, not dishwasher-safe, with feet, for glass insert item 4991.02 and candles up to Ø 7 cm

item	Ø in cm	height in cm
Z315.01	10	15.5

## candle holder/wind light "Reef"

Set consists of:

**candle holder/wind light "Reef"** made of pewter, surface smooth, food-safe, not dishwasher-safe, with feet, for candles up to Ø 7 cm

**glass insert** made of borosilicate glass, satined inside, open at the top and at the bottom, 1 set in black gift box

item	Ø in cm	height in cm	PU
Z316.PB	10	16.5	1 set (2 parts) 

# Showpieces of table culture - "Reef"

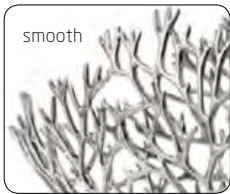

## bowl/basket "Reef"

pewter, smooth outside, round, food-safe, not dishwasher-safe, with supporting feet, for small glass bowl item 5166 (please order separately)

item	Ø in cm	height in cm
2310	13	8



## glass bowl

glass, 6 mm thick, dark grey, organically shaped, for bowl/basket "Reef" item 2310 (please order separately)

item	Ø / height in cm	content in l	PU
5166	13 / 6,5	approx. 0.3	2 pcs



## bowl/basket "Reef"

pewter, smooth outside, round, flat, food-safe, not dishwasher-safe

item	Ø in cm	height in cm
2311	22	5

New



## small bowl/basket "Reef"

pewter, smooth outside, round, food-safe, not dishwasher-safe, with supporting feet, for small glass bowl item 4859.07, 4860.07 and 4930 (please order separately)

item	Ø in cm	height in cm	PU
2318	8	5	2 pcs



## small glass bowl

borosilicate glass, handblown, round for small bowl/basket "Reef" item 2318

item	Ø / height in cm	content in l	PU
4930	7/5	0.14	24 pcs

## glass bowl

glass, 2 layers, handmade, heavy quality, Ø 7 cm, 4.5 cm high, approx. 0.08 L content, for bowl/basket "Reef" item 2318

item	colour	PU
4859.07	white	6 pcs
4860.07	black	6 pcs



## Info:

Since medieval times, pewter has been used primarily for table top items and has been the most important raw material for a very long time. The popularity of pewter first started decreasing in the 18th and 19th century by the progressing development of glass and the increasing popularity of porcelain. Since then the usage of pewter has shifted mainly to decorative elements. Up-to-date pewter is 100 % lead-free and therefore uncritical when used for food.





# "Matrix"



## bowl "Matrix"

brass, top golden (transparent coating, food-safe), bottom dark patinated, hexagonal, flat, not dishwasher-safe

item	Ø in cm	height in cm
2382.38	38	7



## bowl "Roots"

brass, golden (transparent coating, food-safe), round, not dishwasher-safe

item	Ø in cm	height in cm
2381.38	38	8

## bowl "Roots"

in black gift box

item	Ø in cm	height in cm
2381.38PB	38	8



## bowl/display "Fakir"

brass, inside golden (transparent coating, food-safe), outside dark patinated, not dishwasher-safe

item	Ø in cm	height in cm
2380.07	7.5	11
2380.12	12.5	10
2380.15	15	8.5
2380.18	18	9.5

The silicone feet may be attached if needed.



## coaster/glass insert

hardened clear glass, 4 mm thick, round, edge polished and deburred, with 4 transparent silicone feet

item	Ø in cm	PU
5244.11	11	6pcs
5244	13	6pcs
5244.17	16.7	1 pc
5244.21	20.7	1 pc
5244.24	24.2	1 pc
5244.28	28.2	1 pc



The buffet stands of the "Somnia" series are available on page 8.





## “Roots, Matrix & Fakir” - Brass all of a piece!



### “Fakir”

Massive brass, produced in traditional sand casting, creates unique sculptural items, which enthuse especially by their contrast between matt golden surfaces and dark patination. Opposing in form and shape but still belonging together, the bowls “Roots” and “Matrix” as well as the exceptional displays of the “Fakir” series, add up to a harmonic overall composition.

The bowls “Roots”, a tight web of rootlike structures, and “Matrix”, strictly geometrically constructed of hexagons, could hardly be more opposing. Especially this aspect makes the combination of the two so interesting. Besides the presentation of bread and fruit on the buffet, these bowls fascinate as sculptures or decorative elements as well. An interesting add-on to the “Fakir” bowls are round glass platters of the Zieher product range. These can be laid on easily and thus generate the option to use the impressive objects on both sides.

All items are golden-coloured and partially dark patinated, further discolouration or oxidation is prevented reliably by the food-safe sealing of the golden parts.





# "Unique"



The total series "Unique" is available on page 146 and 147.

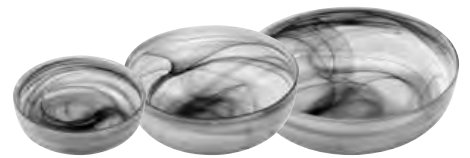

## glass bowl "Unique"

glass, black marbled, outside satined, round

item	Ø in cm	height in cm	content in l	PU
5183.16	16	5	approx. 0.67	6 pcs
5183.21	21	8	approx. 2.0	4 pcs
5183.27	26.5	8	approx. 2.75	4 pcs



## glass bowl "Unique"

glass, white marbled, outside satined, round

item	Ø in cm	height in cm	content in l	PU
5182.16	16	5	approx. 0.67	6 pcs
5182.21	21	8	approx. 2.0	4 pcs
5182.27	26.5	8	approx. 2.75	4 pcs

# Manufactured in old tradition!



Each of these high grade bowls is unique and almost completely handcrafted. At this, coloured glass is completely covered with crystal clear glass. This process awards the bowls with top brilliance and an impressive look. The handblown glass blank is modelled manually, whereby unique pieces are created which excite by their organic shape.



## bowl

clear glass, black, handblown, wavy, with clear rim

item	Ø in cm	height in cm
4811.01	39	9.5
4811.02	51	14

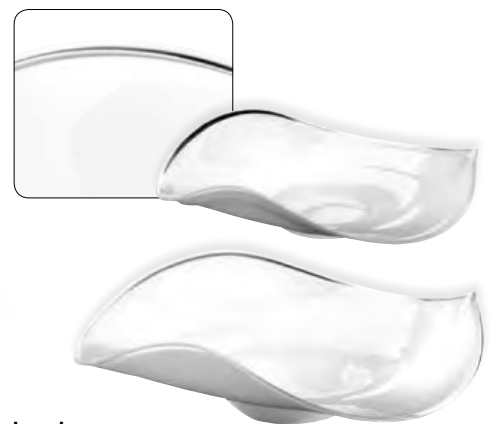

## bowl

clear glass, white, handblown, wavy, with clear rim

item	Ø in cm	height in cm
4810.01	39	9.5
4810.02	51	14

Please note:  
Due to the complex production process, small air inclusions in the glass are inevitable!

Ivory-coloured clamshells with a nacreous gloss grant these products their special appeal. In combination with crushed ice and the Zieher rechargeable LED-lights, the double-walled bowls produced in mosaic-look create fascinating effects, thus becoming the eye-catcher at the buffet. The double-walled construction provides insulating characteristics. This prevents the formation of condensation on the outside of the bowls to the greatest possible extent. More items of the series are available on page 180.



**bowl "Capiz"**

shell, ivory-coloured, double-walled, round, rim approx. 2 cm wide, resin-coated, not dishwasher-safe

item	Ø in cm	height in cm
7109.46	46	23

**bowl "Capiz"**

in black gift box

item	Ø in cm	height in cm
7109.46PB	46	23



Separates ice and melt water



**charger plate, white glass**

special hardened safety glass, 4 mm thick, white, edge polished, dishwasher-safe, with rubber feet (adhesive), underside scratch-proof

item	Ø in cm
1671.33	33

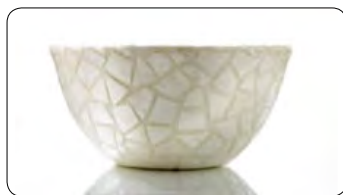

The rechargeable LED-light item 8150 is available on page 45.

**bowl "Capiz"**

shell, ivory-coloured, double-walled, round, with slightly cone-shaped bottom, rim approx. 3 cm wide, resin-coated, not dishwasher-safe

item	Ø in cm	height in cm
7112.36	36	17.5



**bowl "Capiz"**

shell, ivory-coloured, oval, resin-coated, not dishwasher-safe

item	l x w x h in cm
7106.46	46.5x24x13.5





NEW

# Platters and bowls made of grey glass



The gold-plated napkin ring "Reef" is available on page 66.



### glass platter/tray

glass, structured, dark grey, rectangular, with handles

item	version	l x w x h in cm	PU
5021.01	1/1 GN	53x32.5x2	3 pcs
5021.02	1/2 GN	32.5x26.5x2	4 pcs
5021.03	2/4 GN	53x16x2	4 pcs

The buffet crosses "StiXXX" made of laminated plastic are available on page 27.

The buffet stands "Crossline" are available on page 14.

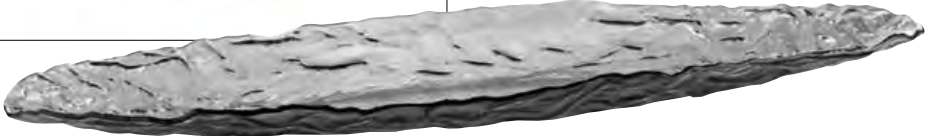

### buffet bowl

glass, 8 mm thick, dark grey, oval, structured, delivery in strong wooden box

item	l x w x h in cm
5176	130x42x8



### glass bowl

glass, 6 mm thick, dark grey, oval, structured

item	l x w x h in cm
5175.41	41x19.5x5.5
5175.44	44.5x25x6





The rechargeable LED-light item 8150 is available on page 45.

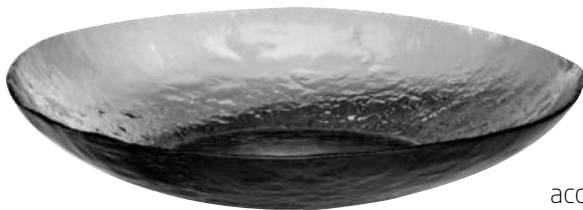

This monumental bowl made of dark grey glass arches like a sculpture and melts optically with crushed ice to stage classy seafood or champagne in an opulent way.

In combination with the Zieher rechargeable LEDs, which perfectly accentuate the irregular structure of the glass, the presentation becomes even more dramatic! This effect is further intensified by the optical refraction of the ice.

This impressive bowl with a diameter of 82 cm can be placed free-standing on the floor by using the fitting rack (Art. 8213). But also right at the buffet table or arranged together with the stands of the "Crossline" series in different heights - these designer pieces know how to impress.

### buffet bowl

glass, 8 mm thick, dark grey, round, structured, delivery in strong wooden box

item	Ø in cm	height in cm
5704	82	15



### rack for XXL bowls

steel, matt black (powder-coated), three-part for self assembly, adjustable feet for firm positioning on most surfaces, for XXL bowl "Konkret!" item 8212.D and XXL glass bowl item 5704

item	l x w x h in cm
8213	70x70x57



### buffet stand "Crossline"

galvanised steel, matt black (powder coating), square, hinged beams on top

item	l x w x h in cm	l x w in cm (on top)
8320.15	41.5x41.5x15.5	34x34
8320.31	49.5x49.5x31	34x34







**glass tray**

glass, dark grey, rectangular

item	l x w x h in cm
5161.31	31x21x3.5
5161.62	62x21x3.5



**glass tray**

glass, satined, rectangular

item	l x w x h in cm
5160.31	31x21x3.5
5160.62	62x21x3.5



**glass platter**

glass, structured, transparent, square

item	l x w in cm
5063	30x30
5063.50	50x50



**buffet bowl**

glass, satined, square

item	l x w in cm
5014.38	38x38



**buffet bowl**

glass, transparent, wide rim, structured

item	Ø in cm	height in cm
5049.35	35	6



**buffet bowl**

glass, transparent, wide rim, structured

item	Ø in cm	height in cm
5024.45	45	11



**buffet bowl**

glass, satined, concentric shape with steps

item	Ø in cm	height in cm
5013.46	46	5.5



The buffet displays "Classy" are available on page 34 and 35.

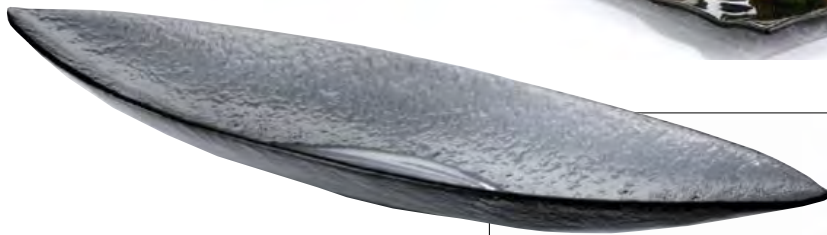

**buffet bowl**

glass, 8 mm thick, dark grey, oblong, structured

item	l x w x h in cm
5703	96x29x10



**glass plate**

glass, 8 mm thick, dark grey, rectangular, with the structure of tree bark

item	l x w in cm	PU
5702	40x22	2 pcs



**glass plate**

glass, 8 mm thick, dark grey, oval, with the structure of tree bark

item	l x w in cm	PU
5700	33x24	3 pcs



**glass bowl**

glass, 8 mm thick, dark grey, oval, with the structure of tree bark

item	l x w x h in cm	PU
5701	26.5x19.5x4.5	3 pcs





# "Cave"



The glass version of the "Cave" bowl is available in two sizes. The soft tinge of this grey glass, which is manufactured in a traditional hand-blowing process, at first glance allows an unobstructed view onto the content of these shapely objects. They offer the fitting framework for fruit, nuts and nibbles as well as for tastefully arranged pasta or salad on a solemnly decorated table. The content of the bowls remains protected by the shell of glass, the amply dimensioned opening seduces to snap at a chance. These unique items also enthuse as a place to keep all kinds of accessories. "Cave" in a smaller version, made of china, is available on page 155.



## glass bowl "Cave"

dark grey, round, handblown, ground edge

item	Ø in cm	opening Ø in cm	height in cm
4815.18	approx. 18	approx. 14	approx. 11.5
4815.24	approx. 24	approx. 19	approx. 16.5

# "Duplex"

The solid coloured grey glass of these unique handblown pieces serves as an unobtrusive background and suitable framework for perfectly arranged dishes. The bowls can be used on both sides. A soft recess is formed when the closed side is up for ambitious dishes. By using it upside down, there will be more capacity, which is ideal e. g. to fill in crushed ice.



The rechargeable LED-light item 8150 is available on page 45.



Useable on both sides!



## glass bowl "Duplex"

dark grey, round, bottom side open, useable on both sides

item	Ø in cm	height in cm
4813.28	28	6,5
4813.35	35	7,5
4813.46	46	10



We recommend the use of the silicone rings items 4681... with the smallest bowl



### glass bowl

dark grey, round, handblown, ground edge

item	Ø in cm	height in cm	content in l
4814.17	17	5,5	approx. 0,3
4814.23	23	9,5	approx. 1,5
4814.30	30	13	approx. 3,25
4814.40	40	10	approx. 4,5

4814.17 + 4681.S



### ring "SelectionA."

silicone, Ø 8.3 cm, for glass bowl item 4814.17

item	colour	PU
4681.S	black	6 pcs
4681.W	white	6 pcs

4814.23 + 4682.S



### ring "SelectionA."

silicone, Ø 13.4 cm, for glass bowl item 4814.23 and 4814.30

item	colour	PU
4682.S	black	3 pcs
4682.W	white	3 pcs



4679.S + 8150

### stand/ring, illuminatable

silicone, black, Ø 15.2 cm, usable as an optional stand, for glass bowls item 4814.23 and 4814.30, suitable for rechargeable LED-light item 8150 (page 45)

item	Ø in cm	height in cm
4679.S	15,2	5,5



The buffet displays "Spike" are available on pages 10 and 11.

The buffet stands "Somnia" are available on pages 8 and 9.





# "Artisan"



Please note: When cleaning in the dishwasher, the brass rim may change colour in the course of time. Therefore it is recommended to clean these items by hand.



## bread/pastry bowl "Artisan"

stainless steel 18/10, inside polished, outside matt finish, oval, flat, hammered rim with golden adornment (brass), bottom smooth finish

item	l x w x h in cm
2372	22x15x3.5

## bread/pastry bowl "Artisan"

stainless steel 18/10, inside polished, outside matt finish, oval, high, hammered rim with golden adornment (brass), bottom smooth finish

item	l x w x h in cm
2373	22x13x7

## bowl "Artisan"

stainless steel 18/10, inside polished, outside matt finish, round, hammered rim with golden adornment (brass)

item	Ø in cm	height in cm	content in l
2371.07	7.5	3.5	approx. 0.1
2371.11	11	5.5	approx. 0.3
2371.14	14.5	7	approx. 0.7
2371.16	16.5	8	approx. 1.0
2371.21	21.5	9	approx. 2.0



**tray "Artisan"**

stainless steel 18/10, inside polished, outside matt finish, oval, hammered rim with golden adornment (brass), utility space smooth finish

item	l x w in cm	height in cm
2374.24	24.5x15	approx.1.5



**tray "Artisan"**

stainless steel 18/10, inside polished, outside matt finish, round, hammered rim with golden adornment (brass), utility space smooth finish

item	Ø in cm	height in cm
2370.23	23	approx.2.5
2370.28	28	approx.3
2370.33	33	approx.3



**etagere "Artisan"**

stainless steel 18/10, inside polished, outside matt finish, round, not dishwasher-safe, hammered rim with golden adornment (brass), with brass handle, demountable, with 3 rubber feet

item	Ø in cm	height in cm
2376	33/28/23	45

The trays and bowls of the "Artisan" series are fascinating and diversified at the same time. The inside with its perfectly polished surface creates an interesting contrast to the matt outside.

The handcrafted rim impresses by its irregularity and is crowned by a circumferential brass edge. The combination of hammered and plain surfaces, of massive stainless steel and brass, awards this series with that certain something.

"Artisan" is a series of contrast!



The plane surface of the trays facilitates the service and prevents unpleasant noise. When used at the buffet, arranged food can be presented in an appealing way and is accentuated by the reflection of the polished surfaces.



# Stainless steel - refined!



stainless steel, polished



golden

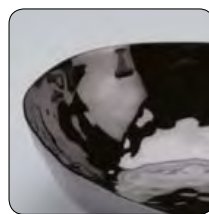

black

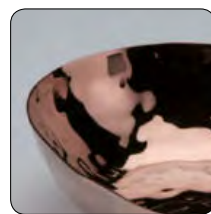

copper



We gladly offer you buffet displays, bread baskets or cruet stands etc. with different surfaces. This option is feasible for almost all products made of stainless steel.

Highly polished as well as matt stainless steel can be finished in golden, copper or black colour using the PVD process. Price, minimum order quantity and delivery time upon request. Please ask us, we will gladly prepare an individual offer for you!

## Advantages of the PVD coating:

- Food-safe
- Dishwasher-safe
- Better strength and adherence compared to galvanic refinement
- Brilliant colouring, colourfast and resistant against UV radiation

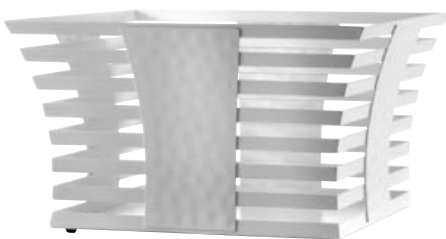
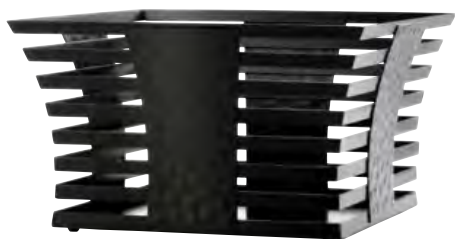

All items made of stainless steel can be powder-coated in all current RAL colours upon request. In contrast to PVD refining, this coating is not dishwasher-safe. We will be delighted to advise you!

"Medusa"



**bowl "Medusa"**

massive stainless steel 18/10, organically shaped, hammered finish, polished

item	l x w x h in cm
2120.15	15.5x15.5x14
2120.25	25.5x25x16.5
2120.38	38x38x23

**bowl "Medusa"**

in black gift box

item	l x w x h in cm	
2120.15PB	15.5x15.5x14	
2120.25PB	25.5x25x16.5	

**"Medusa" - risen from the deep-sea**

These organically shaped bowls appear like creatures of the sea which float silently through the depth of the ocean. Even if the tentacles, modelled in numerous processing steps, appear very filigree, they still provide a safe base. Despite the solid stainless steel, these hammered bowls award a natural airiness and an almost floating impression.

"Medusa" offers the perfect setting for all sorts of seafood or extravagantly presented salads and desserts. Even as a decorative storage space, these bowls cut a good figure.





# "Art de Buffet"



## etagere

massive stainless steel 18/10, round, hammered finish, six times polished, with stainless steel feet, not demountable

item	Ø in cm	height in cm
2197	50/40/30	33

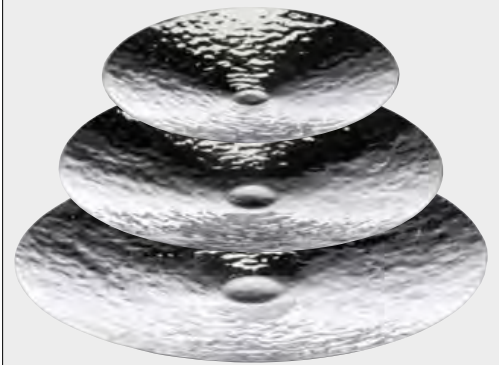

## bowl

massive stainless steel 18/10, hammered finish, six times polished, with 4 feet

item	Ø in cm	height in cm
2199.30	30	3,5
2199.40	40	4,5
2199.50	50	5

Feet ensure safe standing!



## bowl "Wings"

massive stainless steel 18/10, hammered finish, six times polished

item	l x w x h in cm
2169	approx. 34x22x48
2169.01	approx. 21x12.5x30.5
2169.02	approx. 15.5x9x19

The exceptional design of the "Art de Buffet" series acts as an eye-catcher at both modern and elegantly traditional buffets. It presents artistically arranged dishes in a favourable way. Every piece of this series is made of massive stainless steel 18/10, has a hand-made hammered finish and is six times hand-polished.

Please note: The baseplate has to be mounted!



## "Art de Buffet"



The bread/pastry bowls are available on page 84.

### bowl "Loop"

massive stainless steel 18/10, oval, hammered finish, six times polished, with black marble foot

item	l x w x h in cm
2109	approx. 39x19x67



### bowl "Sixth Sense"

massive stainless steel 18/10, hammered finish, six times polished, with stainless steel feet

item	l x w x h in cm
2171	approx. 48x25x74
2171.01	approx. 37x17.5x54
2171.02	approx. 20x12x34



The XXL bowl item 2170 is available on page 87.

2171





item 2125.24

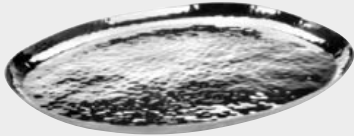
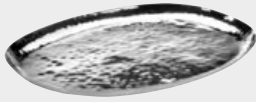

**tray**

massive stainless steel 18/10, oval, hammered finish, polished

item	l x w in cm
2125.24	24x20
2125.36	36x30



**bread/pastry bowl**

massive stainless steel 18/10, hammered finish, six times polished

item	l x w x h in cm
2133.12	12x7.5x4.5



**bowl**

massive stainless steel 18/10, oval, hammered finish, six times polished

item	l x w x h in cm
2183	40x23x18



**bowl**

massive stainless steel 18/10, round, high, hammered finish, six times polished

item	Ø in cm	height in cm	content in l
2181.14	14	7.5	1.0



**bowl**

massive stainless steel 18/10, round, hammered finish, six times polished

item	Ø in cm	height in cm	content in l
2181.17	17	6.5	1.1
2181.21	21	8	2.0
2181.24	24	9.5	3.25



**small bowl**

massive stainless steel 18/10, round, hammered finish, six times polished

item	Ø in cm	content in l
2153	7.5	0.11



**small bowl**

massive stainless steel 18/10, round, smooth finish, six times polished

item	Ø in cm	content in l
2153.01	7.5	0.11

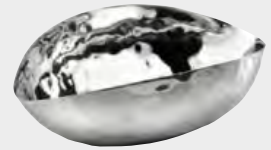

**bread/pastry bowl**

massive stainless steel 18/10, hammered finish, six times polished

item	l x w x h in cm
2121.22	24x15x8



**bowl**

massive stainless steel 18/10, oval, smooth finish, six times polished

item	l x w x h in cm	content in l
2159.16	16x10x7	0.2
2159.20	20x12x9	0.35

**bowl**

in black gift box

item	l x w x h in cm	content in l
2159.16PB	16x10x7	0.2
2159.20PB	20x12x9	0.35



smooth



**etagere**

massive stainless steel 18/10, triangular, smooth finish, six times polished, not demountable

item	Ø in cm	height in cm
2187	13	16.5



**bowl**

massive stainless steel 18/10, triangular, smooth finish, six times polished

item	Ø in cm	height in cm	content in l
2182.09	9	4	0.08
2182.13	13	6	0.28
2182.22	22	10.5	1.25
2182.30	30	12	3.0



hammered



**bowl**

massive stainless steel 18/10, triangular, hammered finish, six times polished

item	Ø in cm	height in cm	content in l
2180.09	9	4	0.08
2180.13	13	6	0.28
2180.22	22	10.5	1.25
2180.30	30	12	3.0
2180.40	40	16	7.0

**bowl**

in black gift box

item	Ø in cm	height in cm	content in l
2180.22PB	22	10.5	1.25
2180.30PB	30	12	3.0



The silicone rings are available on page 158.





The glass bowls are available on page 74.



### buffet stand

massive stainless steel 18/10, highly polished

item	Ø in cm	height in cm
2141.01	25/20	13
2141.02	27/22	17,5
2141.03	29,5/25	23



8005.21 (page 47) + 2141.03



2174 + 2141.01



### bowl

massive stainless steel 18/10, oblique, hammered finish, six times polished

item	Ø in cm	height in cm
2174	38	7/15

It is recommended to clean the horn-ball feet only with moist, soft tissues and non-abrasive substances. Cleaning in the dishwasher may damage the sealing.

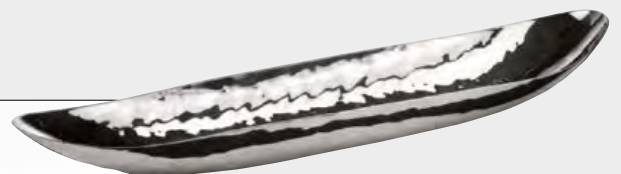

### buffet bowl

massive stainless steel 18/10, oblong, hammered finish, six times polished

item	l x w x h in cm
2184	62x15x7



### buffet bowl

massive stainless steel 18/10, square, hammered finish, six times polished, with horn-ball feet

item	l x w x h in cm
2132	31x31x17

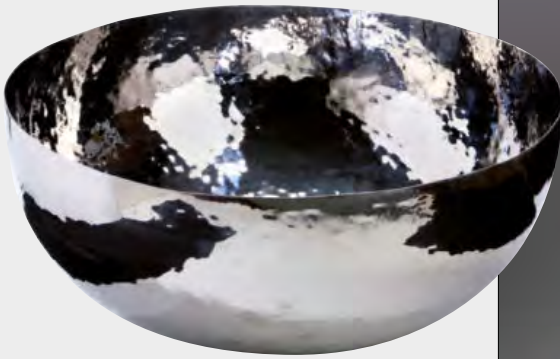

### bowl/basin XXL

massive stainless steel 18/10, round, hammered finish, six times polished

item	Ø in cm	height in cm	content in l
2170	70	30	85.0

### illuminated champagne bowl

set consists of:

**champagne bowl** made of massive stainless steel 18/10, polished

**2 rechargeable LED-lights** with charging station and remote control

**separating plate** made of hardened glass (10 mm thick), satined

item	Ø / height in cm	content in l	PU
2200.PB	70 / 30	85.0	1 set (6 parts)

2170 + 8150 + 5240.M  
Separates ice and melt water



### buffet platter/separating plate

hardened glass, 10 mm thick, satined, round, reduces useable capacity of XXL bowl to approx. 40 l content (15 cm useable depth)

item	Ø in cm
5240.M	60



### champagner bowl

massive stainless steel 18/10, hammered finish, six times polished

item	Ø in cm	height in cm	content in l
2163	39	19	18.0



### hand pump

highly elastic PVC, 2.5 mm thick, with hose, for easy drainage of melt water, professional quality, vacuum capacity: 10 l/min

item	Ø hose in cm	total length hose in cm
5662	2	250

"Art de Buffet"



2163 + 5024.45 (Seite 72)

The bowl "Sixth Sense" in 3 sizes is available on page 83.





NEW

# Buffet bowls



## bowl

massive stainless steel 18/10, oblong, inside stripes decoration, hammered finish, six times polished

item	l x w x h in cm
2130	40x20x6

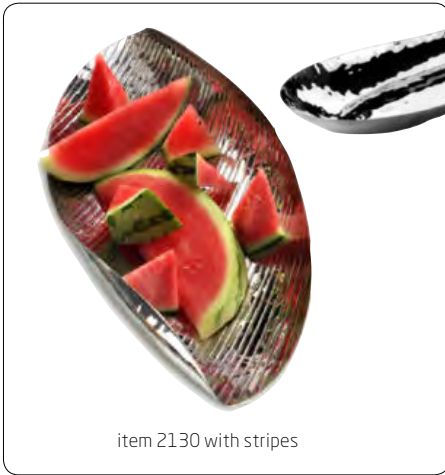

item 2130 with stripes

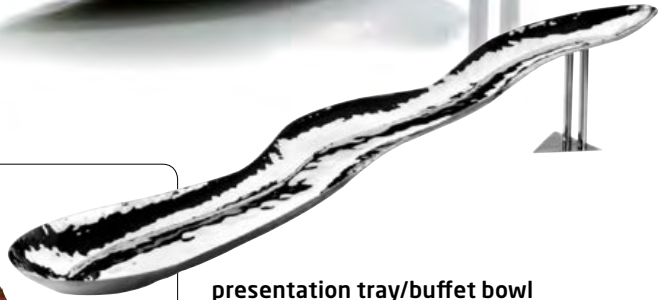

## presentation tray/buffet bowl

massive stainless steel 18/10, hammered finish, polished, incl. removable pedestal for oblique placement

item	l x w x h in cm	l x w x h in cm without ped.
2123	97x19x20	97x19x6



## bowl

massive stainless steel 18/10, oblong, hammered finish, six times polished

item	l x w x h in cm
2116.32	32x12.5x5
2116.41	41x15.5x6.5
2116.71	71.5x22.5x11

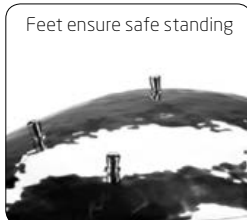

Feet ensure safe standing

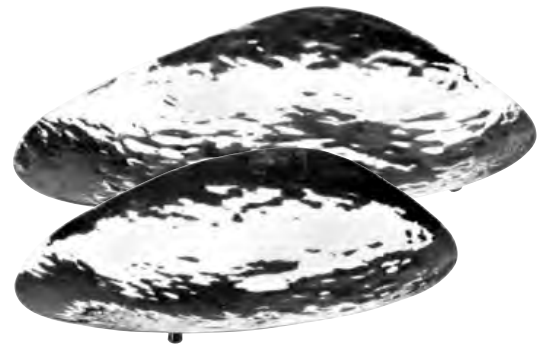

## bowl flat

stainless steel 18/10, hammered, polished

item	l x w x h in cm
2206.50	50x40x6.5
2206.60	60x46x7.5

## bowl flat

in black gift box

item	l x w x h in cm
2206.50PB	50x40x6.5

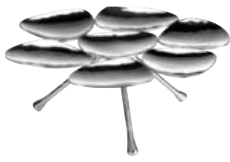

### etagere with 1 tier

massive stainless steel 18/10, hammered, polished, 7 miniature plates (approx. 9 cm x 8 cm)

item	Ø in cm	height in cm
2202	25	9

### etagere with 1 tier

in black gift box

item	Ø in cm	height in cm
2202.PB	25	9



### etagere with 3 tiers

massive stainless steel 18/10, hammered finish, polished, 21 miniature plates (approx. 9 cm x 8 cm)

item	Ø in cm	height in cm
2201	25	44.5

### etagere with 3 tiers

in black gift box

item	Ø in cm	height in cm
2201.PB	25	44.5



### amuse gueule stand with foot

massive stainless steel 18/10, polished

item	l x w x h in cm
2204.08	11.5x9.5x8.5
2204.11	11.5x9.5x11.5



### ice cream cup with foot

massive stainless steel 18/10, hammered, polished

item	l x w x h in cm	content in l
2207.11	11.5x10x11	0.15
2207.15	13.5x11x15	0.25

# "Flower Tower"



Design: Itamar Harari

## Floral shapes in a steely gloss!

Seemingly organic shapes in an interplay with the gloss and reflections of hammered and polished stainless steel make up the special charm of this product line. Different etageres and plateau plates (page 93) allow a visually harmonious yet flexible and diversified presentation of appetizers or desserts on the buffet. But also finger food, petit-fours, elaborately decorated cup cakes or a selection of chocolates in the guest room will find a convenient stage on these products. The ice cream/sorbet cups and petit-fours stands in various sizes make a nice complement and individually stage appetizers or a dessert.

The formal base for all products is a slightly arched and kidney-shaped miniature plate. On three levels, the buffet etagere combines seven small plates each to a presentation platform of floral appearance and offers space to present up to 21 delicacies in a compact and stylish way. The single levels are supported by a filigree trestle made of massive stainless steel, which in shape and construction, deliberately readopts the design of other Zieher etageres. So nothing gets in the way of a harmonic combination of the different product lines.

The table etagere consists of one level only and is therefore perfectly suitable for the restaurant service to present intermediate courses, antipasti or dessert variations. This product is the ideal choice - even as a stylish storage dish for different types of fruit or accessories of daily use.





NEW

# "Flower-Tree"

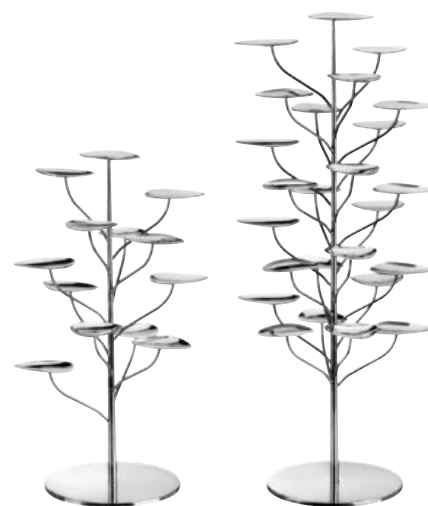

### etagere "Flower-Tree"

massive stainless steel 18/10, smooth finish, polished, Ø29 cm, with miniature plates (ca. 9 cm x 7.5 cm)

item	height in cm	number of levels
2208.13	51.5	13
2208.25	71	25

### etagere "Flower-Tree"

in black gift box

item	height in cm	number of levels
2208.13PB	51.5	13 

## "Flower-Tree" - a tree to dream of!

On 13 resp. 25 levels, these trees offer the possibility to present and showcase finger food, petit-fours and other delicacies. Also a selection of jam in handy jars can be presented in an appealing way as well as fresh apples which, placed on the leaves, invite to take one. These masterpieces of craftsmanship also accentuate the beauty of each lobby by its decorative character.

The shape of the leaves is based on the already existing plateau plates and "Flower-Tower" etageres (page 89 and 93). Especially on the buffet, this opens up the option to arrange the buffet installations diversified, but nevertheless harmoniously and variable.



The plateau plates are available on page 93.

The "Flex-Tree" enthruses by its versatility! On these trees, plain discs replace the fixed leaves. With a diameter of 5.5 cm, they offer sufficient space to equip the tree either with glass, porcelain or stainless steel miniatures. To be on the safe side, they can be placed on black or white anti-slip silicone pads. This reduces the sound emission and at the same time increases the stability of the used miniatures.

All trees are made of massive stainless steel and are accurately high gloss polished. The 8 mm thick foot is the perfect base and guarantees a safe stand.



Anti-slip pads made of Silicone are available on page 209.

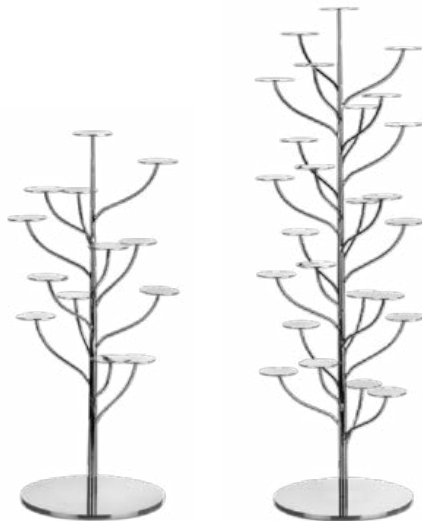

### etagere "Flex-Tree"

massive stainless steel 18/10, smooth finish, polished, Ø 24 cm, with round discs (Ø 5.5 cm)

item	height	number of levels
2209.13	53	13
2209.25	72	25



### Plateau plate "DressCoat"

china, white, also useable as a bowl

item	Ø / height in cm	content in l	PU
4386.01	9/4,5	0.1	12 pcs
4386.02	8/4	0.09	12 pcs

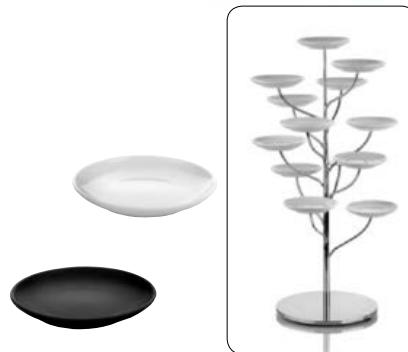

### miniature plate

china, round, flat, Ø 10.5 cm

item	colour	PU
4606.10	white, glossy	12 pcs
4607.10	black, matt	12 pcs



### glass miniature plate

glass, 4 mm thick, green, structured, leaf shape

item	l x w in cm	PU
5037	14x7,5	12 pcs





### holder coil shape

massive stainless steel 18/10, hammered finish, six times polished, for inserts made of china and glass

item	Ø in cm	total height in cm
216715	5.5	20
216720	5.5	25
216725	5.5	30
216730	5.5	35



### marble platter

black/brown, polished surface, sides rough-textured, stainless steel feet, 24 holes (Ø 5 mm), for holder coil shape items 2167... skewer items 1939... or miniature plate items 2203... (please order separately)

item	l x w x h in cm
8052	45x31x5



### skewer

stainless steel 18/10, polished, 24 cm long

item	version	PU
1939.01	Moon	12 pcs
1939.02	Flame	12 pcs



### glass miniature

clear glass

item	Ø / height in cm	content in l	PU
5405	5 / 8.6	0.1	6 pcs



### glass miniature

borosilicate glass, transparent, handblown, double-walled, with reinforced rim

item	Ø / height in cm	content in l	PU
4901.03	6/7.5	approx. 0.08	6 pcs

### miniature

china, stackable, Ø 5.3 cm, 7 cm high, 0.1 l content

item	colour	PU
4490	white	6 pcs
4490.01	black, matt	6 pcs



### marble platter

black/brown, polished surface, sides rough-textured, rectangular, with 3 holes (Ø 5 mm), with 4 feet of felt (not dishwasher-safe), for holder coil shape items 2167..., skewer items 1939... or miniature plate items 2203... (please order separately)

item	l x w x h in cm
8022.02	30x10x2.5



### bowl

granite, anthracite, fully polished

item	Ø in cm	height in cm	content in l
8034	18	7	0.7



Please note:  
Positioning of plateaus  
with same height is only  
possible to a limited extend.



### miniature plate with rod

massive stainless steel 18/10, hammered, polished,  
plate approx. 9x8 cm, for marble platter 8052 and  
8022.02

item	height in cm
2203.08	8
2203.13	13
2203.18	18
2203.23	23

Single presentation plateaus, whose small plates are similar to those of the "Flower Tower" etageres (page 89), are available in four different heights and can be arranged individually. A firm stand for these is offered by the Zieher skewer plates made of dark brown marble, which are available with three and - for the use on the buffet - 24 bore holes.



Design: Itamar Harari



# Etagere "DressCoat"

Food: Pâtisserie Walter  
www.patisserie.de



The etagere with three tiers, made of hammered and highly polished stainless steel, forms an extravagant basis for many sorts of plates and platters. The supporting rings with a diameter of 15 cm offer the possibility to insert not only plates and platters, but alternatively also bowls. Small black silicone rings keep inserted porcelain in position and prevent annoying clattering.

A very special aesthetic set-up can be arranged by using a combination of several etageres along with the biggest plate of the "DressCoat" series (page 148). Numerous presentation areas on a total of four different levels can be created by placing additional plates directly on the table. The diameter of 22 cm is more than sufficient to put different pralines, petit fours and other creations of confectionery into the limelight in an impressive way. In connection with the almost invisible tier stands, the porcelain tablecloths appear amazingly airy and playful by their floating look-and-feel. A buffet presentation with an elegant vibrancy, caused by the drapery of the "DressCoat" plates – that's where it comes into its own!



Anti-slip-rings

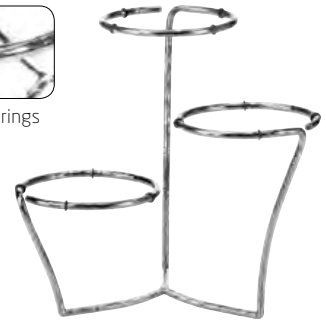

## etagere "DressCoat"

massive stainless steel 18/10, hammered, polished, 3-armed

item	Ø in cm	height in cm
2212.30	36	30

Even in the hotel room, the etageres can be positioned in an eye-catching way. Equipped with "DressCoat" or other tableware, small snacks, a selection of fruit or a sweet welcoming treat can be staged in an appealing way.

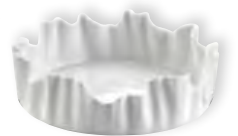

## plateau plate "DressCoat"

white china, useable area (plateau): Ø 19.5 cm, also useable as a bowl

item	Ø / height in cm	content in l	PU
4388	22/6.5	0.9	3 pcs



## glass plate "Unique"

glass, marbled, bottom satined, round

item	Ø in cm	colour	PU
5178.21	21	white	6 pcs
5179.21	21	black	6 pcs

The entire series "DressCoat" is available on page 148, the series "Unique" on pages 146/147.



**etagere**

massive stainless steel 18/10, hammered finish, six times polished, including 3 removable trays item 2110.01 (30 cm long, 8 cm wide, 3 cm high)

item	l x w x h in cm (etagere only)
2110	11.5x11.5x39 (height without handle)



**Elegantly served - stylishly presented!**

Whether it is Five O'Clock Tea, breakfast or finger food - etageres by Zieher offer a maximum use of minimum space.



**tray**

massive stainless steel 18/10, rectangular, hammered finish, six times polished, with feet, for etagere item 2110

item	l x w x h in cm
2110.01	30x8x3



**pastry tray**

massive stainless steel 18/10, rectangular, hammered finish, six times polished

item	l x w in cm
2136	30x12.5



**sushi tray**

massive stainless steel 18/10, hammered finish, six times polished

item	l x w in cm
2160.66	66x8







2107.04 + 4607.10



2107.04 + 4606.10



2107.03 + 4324.11



**etagere**

massive stainless steel 18/10, hammered finish, polished, with 3 or 4 insertion levels (Ø inside: 6.5 cm) for plates/bowls with max. Ø 11 cm

item	l x w x h in cm	levels
2107.03	12.5x11.5x23	3
2107.04	12.5x11.5x29	4



## etagere

massive stainless steel 18/10, hammered finish, polished, with 3 insertion levels (Ø inside: 10.8 cm) for plates/bowls with max. Ø 17.5 cm

item	l x w x h in cm	levels
2105.03	20.5x18x37.5	3



## tray

massive stainless steel 18/10, square, hammered finish, six times polished, with feet

item	l x w x h in cm
2101.17	17.5x17.5x2.3



## Elegantly served and presented in style - classic plate etageres, newly inspired!

Shapely and individual stands by Zieher are suitable for numerous applications. The classic plate etageres are available with three or four levels and in two sizes. Petit-fours, desserts, chocolates or other delicacies are effectively presented by the classic mini format etageres. The larger version is perfectly suitable for scones and jam during Five O'Clock Tea, but also a choice of cold cuts, cheese or fruit can be staged elaborately on the set table. Numerous suitable inserts made of china, glass, and stainless steel are available on pages 248 and 249.



2105.03 + 4607.17



2105.03 + 5179.16



2105.03 + 4606.17



2105.03 + 2101.17





### buffet etagere

massive stainless steel 18/10, hammered finish, six times polished, including 5 trays item 2119.01 (66 cm long, 8 cm wide, 3 cm high)

item	w x d x h in cm	PU
2119	66x54x32	1 set (5 parts)

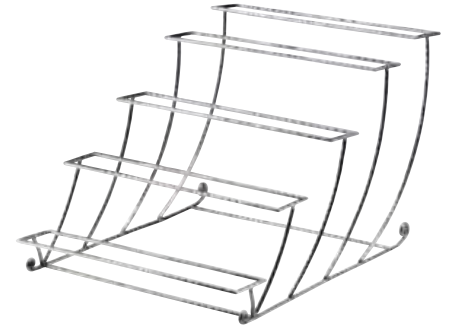

### buffet etagere

massive stainless steel 18/10, hammered finish, six times polished, delivery without trays item 2119.01 (please order separately)

item	w x d x h in cm
2119.02	38x54x31



### tray

massive stainless steel 18/10, rectangular, hammered finish, six times polished, with feet, for buffet etagere items 2119 and 2119.02

item	l x w x h in cm
2119.01	66x8x3



### buffet platter

special hardened safety glass, 4 mm thick, rectangular, rounded edges, polished rim, dishwasher-safe, rubber feet included (adhesive), underside scratch-proof

item	version	l x w in cm
1668.12	black glass	66x10
1670.12	white glass	66x10



### silicone sleeve

transparent, slotted alongside, for buffet etagere items 2119, 2119.02, 2193 und 2193.02 (prevents the slipping of glass platters)

item	length in cm	PU
4683	1	24 pcs

For placement with glass platters we recommend the use of non-slip silicone sleeves (item 4683).







### buffet etagere

massive stainless steel 18/10, hammered finish, six times polished, including 3 trays item 2193.01 (62 cm long, 18 cm wide, 5 cm high)

item	w x d x h in cm	PU
2193	62x42x32.5	1 set (4 parts)



### buffet etagere

massive stainless steel 18/10, hammered finish, six times polished, delivery without trays item 2193.01 (please order separately)

item	w x d x h in cm
2193.02	46x42x31



Glass trays are available on page 59.



### tray

massive stainless steel 18/10, rectangular, hammered finish, six times polished, for buffet etagere items 2193, 2193.02 and 8013

item	l x w x h in cm
2193.01	62x18x5



### buffet platters

laminated plastic, 8 mm thick, middle layer black, break-proof, suitable for dishwashers, antistatic, chamfered edges, rounded corners

item	version	l x w in cm
8001.08	matured wood look, white	80x21
8007.08	rusted look	80x21
8006.08	dark grey	80x21



### buffet platter

tempered glass, grey transparent, irregular colouring in cloudy optics, reverse side structured, suitable for dishwashers, scratch resistant

item	l x w in cm	thickness in mm
8008.08	80x21	8



### buffet platter

special hardened safety glass, 4 mm thick, rectangular, rounded edges, polished rim, dishwasher-safe, rubber feet included (adhesive), underside scratch proof

item	version	l x w in cm
1668.08	black glass	80x21
1670.08	white glass	80x21

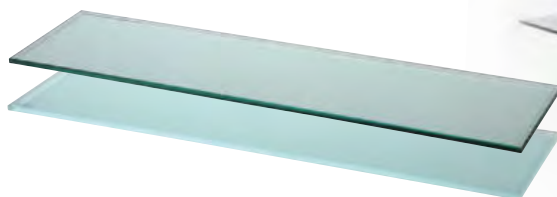

### buffet platter

hardened glass, 10 mm thick, rectangular, edges polished and deburred

item	version	l x w in cm
5243	transparent glass	80x21
5243.M	satined glass	80x21







**dressing/jam jar**  
china, white

item	Ø in	height in cm	content in l
4458	13.5	20	1.75



**table display**

china, white, for self-labeling

item	l x w in cm	PU
4076	8x4.5	6 pcs

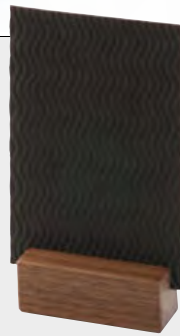

**card holder**

walnut, varnished, slot 2 mm wide

item	l x w x h in cm	PU
4726	8x3x3	4 pcs



**card holder**

stainless steel 18/10, polished, heavy quality, slot 1 mm wide

item	l x w x h in cm
3461	2.5x2.5x2.5



**ashtray for cigars**

optical glass, transparent, also usable as a rest for tongs or spoons, in black gift box

item	l x w x h in cm
5210	15x9x3



**small glass bowl/spoon rest**

glass, 4 mm thick, structured, dark grey, organically shaped, slightly oval form

item	l x w in cm	PU
5172	11x7.5	12 pcs

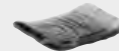

**spoon rest/glass miniature**

glass, 4 mm thick, dark grey, with spiral structure

item	l x w in cm	PU
5168.06	approx. 6.5x5	12 pcs

The platters made of grey glass are available on page 167.





The tongs have a thickness of 4 mm, they rest perfectly in the hand and convey a sense of quality!



The jam trays are available on page 250.



#### tongs holder

massive stainless steel 18/10, hammered finish, six times polished, for tongs up to a length of 24 cm

item	l x w x h in cm
2115	27.5x9.5x28



#### chocolate/ice cube tongs

massive stainless steel 18/10, hammered finish, six times polished, 19 cm long

item	version
2138	stainless steel



#### serving tongs

massive stainless steel 18/10, hammered finish, six times polished, 21.5 cm long

item	version
2140	stainless steel



#### toast rack

massive stainless steel 18/10, hammered finish, six times polished, for 4 slices of toast

item	l x w x h in cm
2190	20x8.5x15



#### spoon rest

massive stainless steel 18/10, rectangular, hammered finish, six times polished

item	l x w in cm
2154	18x10



#### serving tongs

massive stainless steel 18/10, hammered finish, six times polished

item	length in cm
2139	28



# "Fingerfood-Tree"

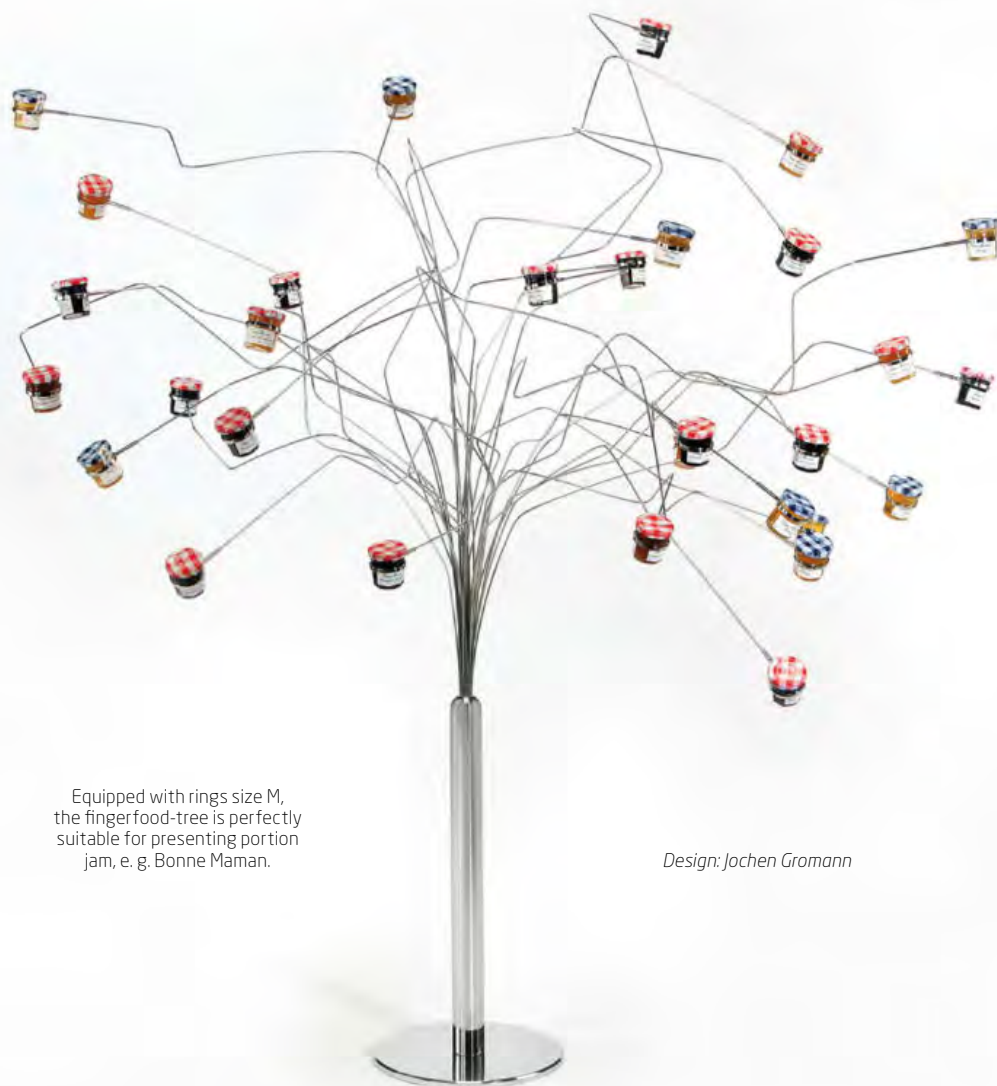

Equipped with rings size M, the fingerfood-tree is perfectly suitable for presenting portion jam, e.g. Bonne Maman.

Design: Jochen Gromann

Please note:

The trees are being delivered with unbent branches; the bending has to be arranged before the first use!

The branches are made of stainless steel and will sag when loaded with food. This is why the branches should not be bent too far down when empty. In order to obtain a more favourable result, it is recommended to bend the branches one by one and to work in a circle from the outside to the inside.

The different attachments can be screwed onto the end of the branches, whereas the connection point should only be tightened up slightly. When using the rings or spiral, it is recommended to leave the connection point open by about half a turn, as they will turn into the apt position by themselves due to the weight of the attachments.



## spring clip support

stainless steel 18/10, polished, to screw onto the "branches" of the fingerfood-tree item 8018.01

item	length in cm	PU
8019.01	7	10pcs

Ring size M is suitable for portion jam in conical glasses (e.g. Bonne Maman)



## ring support

stainless steel 18/10, polished, to screw onto the "branches" of the fingerfood-tree item 8018.01

item	size	Ø in cm (inside)	PU
8019.02	S	2.8	10 pcs
8019.03	M	3.8	10 pcs
8019.04	L	5.6	10 pcs



## spiral support

stainless steel 18/10, polished, to screw onto the "branches" of the fingerfood-tree item 8018.01

item	Ø in cm	height in cm	PU
8019.05	4.5	4.5	10 pcs



For ring size S

## glass cone

clear glass

item	Ø / height in cm	content in l	PU
5415	3.5/8	0.03	12 pcs



For ring size L

## glass miniature

borosilicate glass, transparent, handblown, double-walled, with reinforced rim

item	Ø / height in cm	content in l	PU
4901.03	6/7.5	approx. 0.08	6 pcs



For spiral support

## glass cloche

borosilicate glass, transparent, handblown, handmade

item	Ø in cm	height in cm	PU
4982.05	5	approx. 8-9	6 pcs

# "Fingerfood-Tree"

Wildly bent tree branches, supported by a base made of polished stainless steel: The fingerfood-trees by Zieher are absolutely delightful due to their extraordinary look and variable uses achieved by the different attachments!



Increased stability through larger base plate.



A number of suitable attachments and applications offer a lot of possibilities and form the basis for the chef's imagination. The fingerfood-trees are perfect for patisserie creations, savory snacks in the form of mini-wraps or skewers, fruit with chocolate icing or just for jam at breakfast buffets. Furthermore, they can be placed on both buffets and bar tables with the solid base ensuring stability.

This extraordinary way of presenting fingerfood will surprise and fascinate your guests and will definitely leave a lasting impression.

The fingerfood-trees are furnished with 30 branches, which in turn can be fitted with 5 suitable attachments (page 102). Besides a clip that holds wooden skewers and a spiral for small wraps and waffles, we offer rings in three sizes, of which the medium size is especially designed for holding small jam jars (e.g. Bonne Maman).

Velcro straps to fasten the branches and a stout carrier bag are available from the accessory section and allow easy transport and space-saving storage of the bent trees.



## transport bag

polyester, black, with zip and 2 carrying straps, for fingerfood-tree item 8018.01

item	l x w x h in cm
8018.T	150x29x29

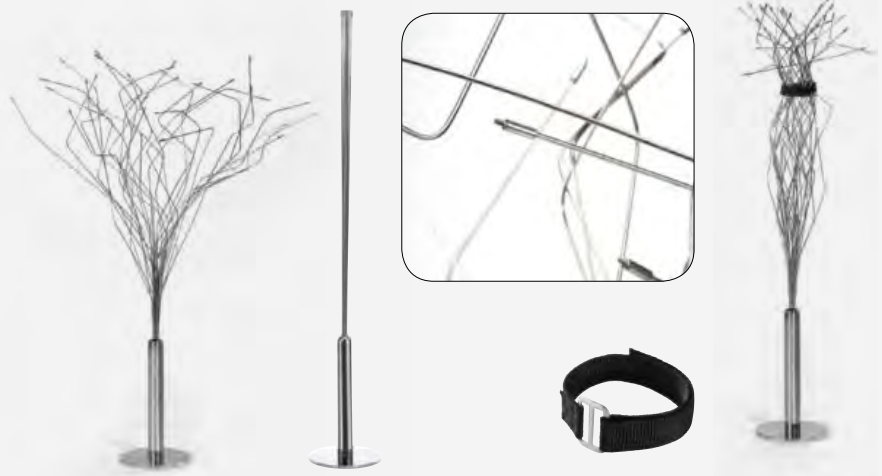

## fingerfood tree

stainless steel 18/10, polished, 30 "branches" of equal length (87 cm) of stainless steel wire, with 6 feet of felt, height after bending of "branches": approx. 90 cm - 110 cm, threaded ends for attachment of several supports items 8019... (please order separately)

item	Ø in cm (foot)	height unbent in cm
8018.01	25	121

## hook-and-loop strap

black, with chrome-plated clasp, for easy transport and space-saving storage of the fingerfood-tree item 8018.01

item	l x w in cm
5660	43x2.5



# "Solid"



Please note:  
The Zieher cutting boards are oiled. The use naturally wears down their surfaces. In case of smaller abrasions, rub down the surface with a thin layer of vegetable oil or special care oil for wooden kitchen counter tops to refresh the surface. The above mentioned items are not dishwasher-safe. Please check the enclosed leaflet for detailed care instructions.



Further sizes and variations of the cloches are available on pages 118/119 and 172 to 179.



4776 + 4880.26



4776 + 4852



4778 + 4880.26



## glass cloche

borosilicate glass, transparent, handblown, handmade

item	Ø in cm	height in cm
4880.26	26	approx. 41-44



## glass cloche

clear glass, handblown, with round handle

item	Ø in cm	height in cm
4852	26	43



## cutting board "Solid"

walnut (end grain), oiled, stackable, not dishwasher-safe, with juice rim/groove to place cloches

item	Ø in cm	height in cm
4776	29	5

## cutting board "Solid"

in black gift box

item	Ø in cm	height in cm
4776.PB	29	5



## stacking ring "Solid"

walnut wood, oiled, not dishwasher-safe, with stacking rim to place cloches

item	Ø in cm	height in cm
4777	29	8.5



## bowl "Solid"

walnut, oiled, not dishwasher-safe, with stacking rim to place cloches

item	Ø in cm	height in cm
4778	29	8.5

NEW



## buffet platter, glass

special hardened safety glass, 49 cm long, 21 cm wide, 4 mm thick, with 2 concave cutouts, rounded edges, polished rim, dishwasher-safe, rubber feet included (adhesive), underside scratch-proof

item	colour
1668.20	black
1670.20	white



The high-quality cutting board made of fine end grain walnut wood is much more than a shapely and elegant kitchen aid. This product only unfolds its full potential in connection with the respective stacking rings and bowls. All parts have a groove at the top, which allows quick and easy stacking of the various items, even in mixed arrangement.

The milled groove of the cutting board serves on the one hand as a juice groove, on the other hand as a receptacle for various glass cloches. Thus aromatic types of cheese can be presented. A classic cloche made of handblown glass or an extravagant organically shaped cover made of highly durable borosilicate glass protects and stages the food at the same time. The stacking ring creates different levels of presentation when used in a clustered arrangement of cutting boards and trays. Also, the capacity of the bowls can be increased so as to present, for example, long baguettes.

Accurately fitting connection plates made of hardened, white or black coloured glass, can be slid exactly into the grooves of the stacked rings and thus work as buffet platters between the columns. This creates additional space and raises the flexibility of this system at the same time. Additional sizes of these plates, made of the same type of glass (page 50/51), offer a nice supplementation and allow an optically balanced buffet presentation.

The system blends in harmoniously into the walnut wood series "Solid". Using further sizes of the glass cloches allow impressive arrangements on the buffet.

Cutting board, ring and bowl are sealed with high quality oils. Especially regarding the cutting board, this enables the simple refurbishment of the surface from traces of daily wear and tear.



4777 + 4778



4776 + 4777 + 4778



4777 + 4778



4776 + 4777 + 4778



4880.26 + 4776 + 4777 + 4778



# "Mercato"

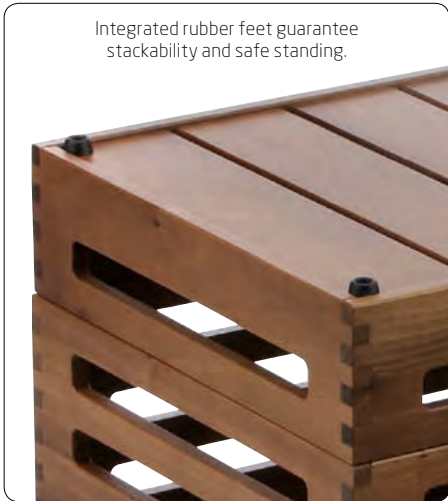

Integrated rubber feet guarantee stackability and safe standing.



The lateral cut-outs are suitable for buffet platters with a max. width of 21 or 34 cm.



## buffet display/basket "Mercato"

walnut, food-safe sealed, not dishwasher-safe, stackable, with 4 rubber feet (screwed on)

item	l x w x h in cm
4768.08	43x30x8
4768.12	43x30x12
4768.16	43x30x16



The “Mercato” buffet baskets made of walnut are inspired by classic market boxes, but they are superior in many respects. Finger joints in the corners for maximum stability, solid walnut in modern design as well as deliberately chosen dimensions of the heights and lateral cutouts offer numerous advantages. “Mercato” can be converted quickly and flexibly into a buffet display by the use of buffet platters. These platters (pages 46 to 53) can simply be laid on or pushed into the lateral cutouts of the baskets (max. width 21 or 34 cm). In addition to the mere presentation of fruit or baked goods, “Mercato” is also ideal for the coffee break or for placing miniatures of any kind.

The integrated rubber feet ensure safe standing and guarantee the stackability of the baskets. Bread, rolls and pastries remain crisp and fresh longer, as the slotted bottom plates allow sufficient air circulation.

The “Solid” bed tray is a nice addition to this system. Due to its integrated foldable feet, there is no need for displays for elevated positioning. For more information on the bed tray, please see page 114, for the fitting “Solid” breakfast buffet, please check pages 108 to 113.





# Bread and more ...

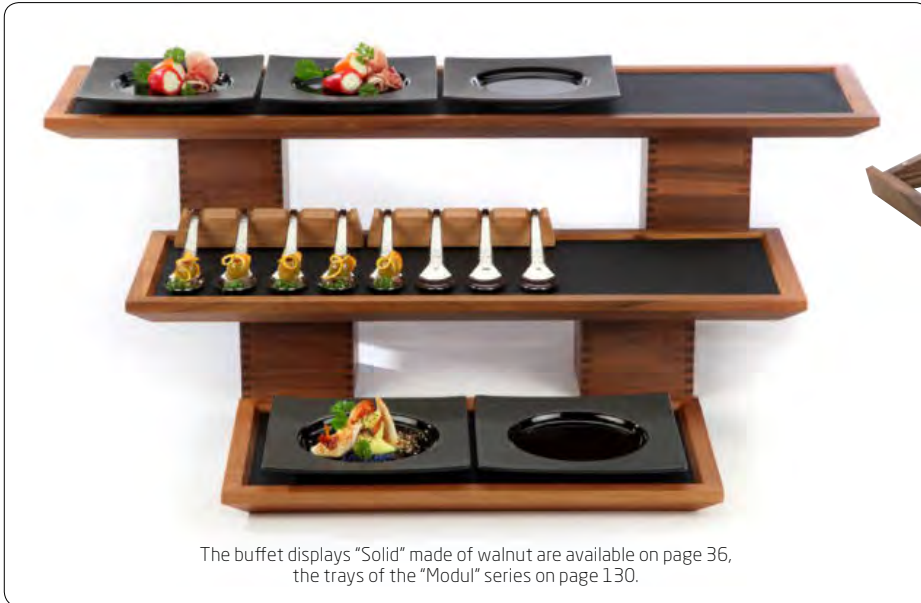

The buffet displays "Solid" made of walnut are available on page 36, the trays of the "Modul" series on page 130.



### tray stand "Solid"

walnut, food-safe sealed, not dishwasher-safe, with 6 rubber feet and 16 anti-slip feet on the top side, for 2 serving trays "Solid" items 4707.PB and 4740

item	l x w x h in cm
4718	72.5x51x22



### tray stand "Solid"

walnut, food-safe sealed, not dishwasher-safe, removable cover strip, with 6 rubber feet and 8 anti-slip feet on the top side, 2 pieces combinable with connector piece "Solid" item 4747 (for buffet setup of two pieces item 4746 one above the other), for 1 serving tray "Solid" items 4707.PB or 4740

item	l x w x h in cm
4746	42x51x13.5



The cutting board and the bridge "Solid" are available on pages 112 and 113.



### connector piece "Solid"

walnut, food-safe sealed, not dishwasher-safe, for buffet setup of 2 pieces of the tray stand item 4746 one above the other, with 2 boreholes for wall mounting (optional, mounting material not included)

item	l x w x h in cm
4747	46.8x12x54.5





... attractively presented!

"Solid"



The presentation of bread is not only important at the table, but at the breakfast buffet, too. The variety of baked goods wants to be put in the limelight.

Oblique displays for one or two wooden trays allow for a clear arrangement of various types of bread. With the help of a connector piece, two of these tray displays (item 4746) may be stacked and used on top of each other - the ideal solution for small buffet tables. A fitting cutting board including a crumb drawer and an exchangeable grate, a cutting board made of end grain wood as well as various bridges (to be found on pages 112 and 113) complete the series and provide the healthy and diversified breakfast with a new look.

Besides the flat bread tray you can also find a deeper version of this tray, which is suited especially for the presentation of rolls, buns, biscuits and pastries. A removable grate provides air circulation, freshly baked buns remain scrumptious longer. Two kinds of divisions (for the tray) offer space for several miniatures (pages 259 and 260) and allow for a flexible use of the system. A cutlery insert for the deep tray as well as an insert for slices of toasted bread round off the range.

Wood from the European walnut tree, which is one of the most precious and most beautiful types of wood, forms the basis for this series. Both the wood's warm brown colours in different shades and its intensive and distinctive grain make every product a unique item!



Suitable miniatures in sizes 5 cm x 5 cm or 7 cm x 7 cm are available on pages 259 and 260.



More items of the "Solid" walnut series are available on pages 230 to 241.





Glass inserts  
1668.03 and 1670.03  
please order separately.

### servicing tray "Solid"

walnut, flat, food-safe sealed, not dishwasher-safe, with 2 recessed grips, with 4 rubber feet, in black gift box

item	l x w x h in cm	l x w (inside) in cm
4707.PB	53x37x4	50.2x34.2



### tray insert "Solid"

walnut, food-safe sealed, not dishwasher-safe, divides the tray into 8 sections (length: 31.9 cm, width: 5.4 cm each), for serving trays "Solid" items 4707.PB and 4740 and miniatures with a max. width / Ø of 5 cm

item	l x w x h in cm
4742	50x34x2.9



### tray insert "Solid"

walnut, food-safe sealed, not dishwasher-safe, divides the tray into 6 sections (length: 31.9 cm, width: 7.5 cm each), for serving trays "Solid" items 4707.PB and 4740 and miniatures with a max. width / Ø of 7 cm

item	l x w x h in cm
4743	50x34x2.9



### glass platter

special hardened safety glass, 4 mm thick, rectangular, rounded edges, polished rim, dishwasher-safe, rubber feet included (adhesive), underside scratch-proof, for serving tray "Solid" items 4707.PB and 4740

item	version	l x w in cm
1668.03	black glass	50x34
1670.03	white glass	50x34



The tray stand/side table "Solid" is available on page 272.



4707.PB + 4741



4707.PB + 4743



4707.PB + 4742



4707.PB + 1668.03  
4707.PB + 1670.03





### servicing tray "Solid"

walnut, deep, food-safe sealed, not dishwasher-safe, 2 recessed grips, with 4 rubber feet

item	l x w x h in cm	l x w (inside) in cm
4740	53x37x10	50.2x34.2



4740 + 4745



### tray insert "Solid"

walnut, food-safe sealed, not dishwasher-safe, divides the tray into 4 sections (length: 32 cm, width: 3x13 cm and 1x8 cm), for serving tray "Solid" item 4740

item	l x w x h in cm
4745	50x34x7



### cutlery insert "Solid"

walnut, food-safe sealed, not dishwasher-safe, divides the tray into 4 sections (length: 24.9 cm, width: 11.2 cm each), for serving tray "Solid" item 4740 (for cutlery with a max. length of 24.7 cm)

item	l x w x h in cm
4744	50x27x7



### grate insert "Solid"

walnut, food-safe sealed, not dishwasher-safe, with 9 rubber feet (6 mm high), for serving trays "Solid" items 4707.PB and 4740

item	l x w x h in cm
4741	49.8x33.8x2



4740 + 4741



4740 + 4744



4740 + 4743



4740 + 1670.03

## "Solid"



The miniatures made of glass and china are available on pages 259 and 260.



Not dishwasher-safe, do not immerse in water!





### bread cutting board "Solid"

walnut, oiled, not dishwasher-safe, with 4 rubber feet, with walnut grate (39.8 cm long, 24.3 cm wide, 1.8 cm high, exchangeable) and 18/10 stainless steel drawer for crumbs (with magnetic fixing)

item	l x w x h in cm
4733	48x32.5x4.3

The changeable grate of the "Solid" cutting board has been constructed to protrude slightly from the cutting board to protect its rim.



### replacement grate "Solid"

walnut, oiled, for bread cutting board "Solid" item 4733

item	l x w x h in cm
4733.R	39.8x24.3x1.8



### cutting board "Solid"

walnut (end grain), oiled, not dishwasher-safe, with 4 rubber feet (screwed on), in black gift box

item	l x w x h in cm
4732.PB	48x32.5x4.8



### cutting board "Solid"

walnut (end grain), oiled, stackable, not dishwasher-safe, with juice rim/groove to place clothes

item	Ø in cm	height in cm
4776	29	5

## Show cooking is a popular trend!

Whether using it for catering, at events or at the hotel's own buffet, the solid wood cutting boards by Zieher are pleasing eyecatchers and offer high functionality. The matching bridges can be equipped with bowls, putting everything tidily within reach for the work behind the buffet.

The dimensions of both cutting boards and bridges have been chosen in such a way, that exactly two boards and two bridges would fit into a regular transportation box. This is extremely useful when it comes to storing the items for their daily use and transportation for catering purposes.

"Solid" is entirely made of walnut, probably the most beautiful and most stylish of the European woods.

More items from this series can be found on pages 230 to 241.



Please note:

The Zieher cutting boards are oiled. The use of the cutting boards naturally wears down their surfaces. In case of smaller abrasions, rub down the surface with a thin layer of vegetable oil or special care oil for wooden kitchen countertops to refresh the surface. The removable grate for the bread cutting board (item 4733) can be ordered separately as a spare part (item 4733.R). The above mentioned items are not dishwasher-safe. Please check the enclosed leaflet for detailed care instructions.





**bridge "Solid"**

walnut, food-safe sealed, not dishwasher-safe, with 4 rubber feet

item	l x w x h in cm
4730	54x17x16



"Solid"



**bridge "Solid"**

walnut, food-safe sealed, not dishwasher-safe, with 3 tapered holes (Ø 12 cm top side/11 cm underside), with 4 rubber feet, for bowls with max. Ø 15 cm

item	l x w x h in cm
4731	54x17x12



**bowl "Shine"**

stainless steel 18/10, outside polished, double-walled, round/oblique, Ø 15.7 cm, 6.7 / 8.8 cm high, 0.5 l content, for bridge "Solid" item 4731

item	colour inside
2260.16	satined (dishwasher-safe)
2261.16	ivory (not dishwasher-safe)
2262.16	taupe (not dishwasher-safe)



**bowl "Catering de Luxe"**

china, white, for bridge "Solid" item 4731

item	Ø / height in cm	content in l	PU
4281	14/7.5	0.35	6 pcs



**ham holder "Solid"**

walnut, food-safe sealed, not dishwasher-safe, granite and massive stainless steel 18/10, with knife rest (for knives with a max. size of 43 cm x 3.5 cm)

item	l x w in cm
4749	50x26



Other kinds of wood upon request! (custom built)



- maple
- ash
- elm

The porcelain pillows "Donna" are available on page 151.



# "Solid"



## bed tray "Solid"

walnut, food-safe sealed, not dishwasher-safe, stackable, with feet, 2 handles, recessed on one side of the rim

item	l x w x h in cm (closed)	l x w x h in cm (set up)
4773	60x40x6,5	74x40x31

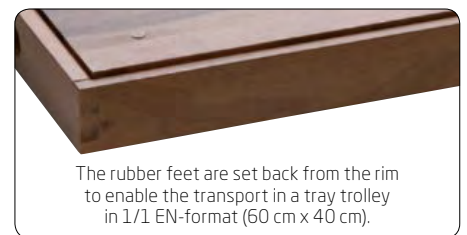

The rubber feet are set back from the rim to enable the transport in a tray trolley in 1/1 EN-format (60 cm x 40 cm).

The room service tray as well as the bed tray with feet stand out due to the precious walnut wood, which is incorporated into these products with high-quality craftsmanship. The recessed longside enables comfortable dining directly off the tray. The retractable feet of the bed tray have been constructed in a very stable way and are securely kept in position by integrated magnets when folded in. The tray also cuts a good figure on the buffet. The positioning feet make it possible to dispense with the use of displays for heightened placing. A speedy set-up and flexible handling facilitate daily operations.



The tray stand for the roomservice tray item 4735 is available on page 272.



## room service tray "Solid"

walnut, food-safe sealed, not dishwasher-safe, stackable, recessed on one side of the rim, with 2 handles, with 4 rubber feet, suitable for tray stand "Solid" item 4748

item	l x w x h in cm
4735	60x40x5,4



The serving tray and suitable glass inserts are available on page 110, more "Solid" items on pages 230 to 241.



## servicing tray "Solid"

walnut, food-safe sealed, not dishwasher-safe, with 4 rubber feet

item	l x w x h in cm	l x w in cm (inside)
4713	34x34x3	32x32

All information about the serving tray "Solid" item 4769 is available on page 276.



## servicing tray "Solid"

walnut, food-safe sealed, not dishwasher-safe, stackable, 2 compartments: 30 cm x 30 cm and 30 cm x 8 cm (for cutlery or china/glass bowls), with 4 rubber feet

item	l x w x h in cm
4769	41.7x32.5x6.7

"Solid"



**serving tray "Solid"**

walnut, oiled, not dishwasher-safe, with changeable insert made of black coloured ceramic

item	l x w in cm
4780.46	46.5x23
4780.67	67.5x33



**insert/platter**

coloured ceramic, 6 mm thick, black, dishwasher-safe

item	l x w in cm
4780.46S	39x19.5
4780.67S	59x29



All information about the trays and suitable inserts are available on page 231.



The cutting boards are pluggable and can be connected with each other.



**cutting/snack board "Connect!"**

walnut, oiled, not dishwasher-safe, pluggable, with handle, with 4 rubber feet, in black gift box

item	l x w x h in cm	length incl. handle
4774.31PB	26.5x20x2.3	31



**cutting/snack board "Connect!"**

walnut, oiled, not dishwasher-safe, pluggable, with handle, with 4 rubber feet, in black gift box

item	l x w x h in cm	length incl. handle
4775.44PB	40x16x2.3	44.5

"Connect!"



**Serving platters made of walnut!**

Sublime in their appearance, unadorned in design, practical by compact formats and highly functional in combination - the solid wood boards of the series "Connect!" convince as a snack board, serving and cutting board or as a presentation platter, created by the combination of several elements. "Connect!" is an extremely versatile tool for everyday use. All information about "Connect!" are available on page 230.



"Solid"



**card holder**

walnut, varnished, slot 2 mm wide

item	l x w x h in cm	PU
4726	8x3x3	4 pcs



**bowl "Solid"**

walnut, oblique, food-safe sealed, not dishwasher-safe

item	Ø in cm	height in cm
4760	13	10,5
4761	14	9



**bowl "Solid"**

walnut, round, food-safe sealed, not dishwasher-safe, stackable, with corrugated pattern outside

item	Ø in cm	height in cm
4711.18	18	6
4711.24	24	8
4711.30	30	10

4710 + 1669.33



The bread bowl is available on page 239.

**serving tray "Solid"**

walnut, round, food-safe sealed, not dishwasher-safe, stackable, with corrugated pattern outside

item	Ø in cm	height in cm
4710	36	4



**charger plate/glass insert**

special hardened safety glass, 4 mm thick, round, polished rim, dishwasher-safe, rubber feet included (adhesive), underside scratch-proof, for serving tray "Solid" item 4710

item	version	Ø in cm
1669.33	black glass	33
1671.33	white glass	33



**charger plate/glass insert**

hardened clear glass, 6 mm thick, round, edge polished and deburred, for serving tray "Solid" item 4710

item	Ø in cm
4999	33





4591 + 4588



### cutlery/napkin box

melamine, black, surface matt, food-safe, dishwasher-safe, with 4 rubber feet, not suitable for microwave and combi steam oven, for cocktail napkins folded to 1/8

item	l x w x h in cm	content in l	PU
4591	16x6x4.5	0.26	2 pcs



### cutlery box

melamine, black, surface matt, food-safe, dishwasher-safe, not suitable for microwave and combi steam oven, for cutlery with a length of up to 23.5 cm

item	l x w x h in cm	content in l	PU
4594	26.5x16.2x7.2	2.25	4 pcs



### cutlery box "Solid"

walnut, food-safe sealed, not dishwasher-safe, with acrylic glass lid, with 4 rubber feet, for cutlery with a length of up to 24.3 cm

item	l x w x h in cm
4720	26.5x16.2x8



### buffet display "Solid"

walnut, food-safe sealed, not dishwasher-safe, bottom side open, can be used as a stand or as a container

item	l x w x h in cm	PU
4767.12	12x12x12	2 pcs
4767.24	12x12x24	2 pcs



4594 + 4589

The melamine tray item 4589 in 1/1 GN format is available on page 125.



Grooves to let water from the dishwasher run off



The cutlery boxes item 4720 (wood) and 4594 (melamine) are stackable in all commercial transport boxes in format 60 cm x 40 cm.



The cutlery-/napkin box for the table is available on page 235.



Each cloche on this page is handblown and handcrafted. In contrast to our cloches made of borosilicate glass (page 119), these items are made of a single massive glass drop. As a result there can be air inclusions and minor streaks which cannot be avoided. Each cloche is individual, the result is a harmonic enlivenment of the buffet for an attractive price.



More cloches made of glass are available on pages 172 to 179.



#### glass cloche

clear glass, handblown, with round handle, for coaster "Solid" items 4734...

item	Ø in cm	height in cm
4850	18.5	31
4851	22.5	37
4852	26	43



#### glass cloche

clear glass, for pastry/cake stand items 5349...

item	Ø in cm	height in cm
5350.16	16	13
5350.23	23	16.5
5350.27	27.5	20.5



#### pastry/cake stand

clear glass, with foot

item	Ø in cm	Ø stand in cm	height in cm
5349.21	21	10.5	9.5
5349.28	28	13	11.5
5349.33	33.5	13	11



### glass cloche

borosilicate glass, transparent, handblown, handmade, for coaster "Solid" items 4734...

item	Ø in cm	height in cm
4880.18	18.5	approx. 29-32
4880.22	22.5	approx. 35-38
4880.26	26	approx. 41-44
4880.30	30	approx. 48-51



### coaster/glass insert

hardened clear glass, 4 mm thick, round, edge polished and deburred, with 4 transparent silicone feet

item	Ø in cm
5244.17	16.7
5244.21	20.7
5244.24	24.2
5244.28	28.2



### coaster "Solid"

walnut, food-safe sealed, not dishwasher-safe, stackable, for glass cloche items 4850, 4851, 4852 and 4880... and glass inserts items 5244...

item	Ø / height in cm	for cloches / inlays
4734.01	23 / 3	Ø 18.5 / 16.7 cm
4734.02	27 / 3	Ø 22.5 / 20.7 cm
4734.03	30.5 / 3	Ø 26 / 24.2 cm
4734.04	34.5 / 3	Ø 30 / 28.2 cm



### cloche with wooden coaster and glass insert

set consists of:

**cloche** made of borosilicate glass

**insert** made of hardened transparent glass (4 mm thick)

**saucer** made of walnut

1 set in black gift box

item	Ø in cm	height in cm	PU
4882.22PB	27	approx. 37-40	1 set (3 parts)
4882.30PB	34.5	approx. 50-53	1 set (3 parts)

Cloches made of borosilicate glass are heat resistant, dishwasher-safe and very easy to handle for the guests. The main features of this material are a great resistance against heat and changes in temperature as well as a high breaking strength. Each item is manufactured by hand and therefore shaped individually.



The cloches "Cuspis" are available on page 172.



The cutting board is available on page 112.





# "Podia"



Hotel cosmetics:  
PAM Berlin Slipper & Hotel Supplies  
www.pam-berlin.de

The buffet bridges and trays of the "Podia" series offer several advantages!

They are light but robust, flexibly usable and can be stored in a space-saving way. With its use as a display on the buffet, during coffee break or as a platter for fruit or little somethings in the hotel room - "Podia" offers multiple possibilities for use and flexible handling.

The tray in 1/2 GN format is especially suitable for different miniatures made of porcelain and glass. Slide-proof silicone coasters in different styles (page 209) guarantee a good grip during service.

All parts of this series consist of form-glued authentic wood veneer. The bridges are available in two types of wood. The light version harmonizes very well with mundane but also with rustic-style furnishing, the version with the black-brown stripes appears exotic and modern.



## 1/2 GN tray "Podia"

genuine wood veneer, dark (black-brown striped), not dishwasher-safe

item	l x w in cm	GN	PU
8732.03	32.5 x 26.5	1/2	6 pcs



## buffet bridge "Podia", triple pack

genuine wood veneer, dark (black-brown striped), not dishwasher-safe

item	w x d x h in cm	PU
8730	30x20x6 (1st bridge)	1 set
	36x20x9 (2nd bridge)	
	42.5x20x12 (3rd bridge)	



## buffet bridge "Podia", triple pack

genuine wood veneer, light colouring (similar to oak), not dishwasher-safe

item	w x d x h in cm	PU
8731	30x20x6 (1st bridge)	1 set
	36x20x9 (2nd bridge)	
	42.5x20x12 (3rd bridge)	



More products from the room service / hotel room field are available on pages 271 to 280.

Not dishwasher-safe,  
do not immerse in water!

# Catering





# "Bento Box"

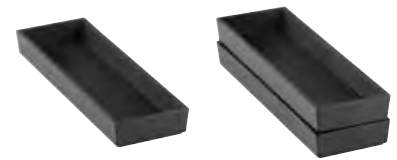

## insert/box

melamine, black, surface matt, stackable, food-safe, dishwasher-safe, not suitable for microwave and combi steam oven, up to 4 pieces fit into item 4578

item	l x w x h in cm	PU
4580	29.5x9x3.3	3 pcs

Available in different colours from 350 sets (box + lid) upon request!



## lid/tray

melamine, black, surface matt, stackable, food-safe, dishwasher-safe, not suitable for microwave and combi steam oven, with ventilation slots, suitable for item 4578, also usable as a tray

item	l x w x h in cm
4579	39.5x31.5x4

The champagne flute "Vaganza" is available on page 198.



The lid of the Zieher "Bento Box" can also be used as a shapely tray.



## Bento Box

melamine, black, surface matt, stackable, food-safe, dishwasher-safe, not suitable for microwave and combi steam oven, partition for cutlery/napkin/inserts (28 cm x 7.5 cm) or for platters (28 cm x 28 cm)

item	l x w x h in cm
4578	39x30.5x8.5



Suitable inserts made of glass and china (7 cm x 7 cm) are available on page 260.



## "Bento Box" - flexible mobility

Serving guests at the pool, beach or on the terrace is often associated with longer walking distances for service staff. The "Bento Box" from Zieher has been designed especially for these requirements – all components are stackable. This way, they guarantee a space-saving storage and a comfortable, non-slip transport, even with several dishes at the same time.

Matt black melamine, modern design and subtle contrasts created by different surface structures, form the perfect setting for individual creations and popular classics such as burgers, club sandwiches or salads.

The box is divided into a main compartment for plates up to a diameter of 28 cm and a narrow side compartment for cutlery and napkin or miniatures made of glass and porcelain.



Optionally available inserts in the same design create additional space for side dishes, sauces or dips, when placed above the cutlery compartment. Up to four of these bowls can be placed in a bento box if required, and, with a correspondingly flat content of the main compartment, create a second level for even more flexibility.

The versatility of the individual components also becomes evident in the cover, which has decorative ventilation slots to dissipate steam generated by hot food. This lid can also be used as a tray, whose less finely textured inside has an anti-slip effect.

Box, insert bowl and lid are sold separately and can be combined as desired. This allows the restaurateur the adaption to his individual needs and helps to optimize additional purchases.

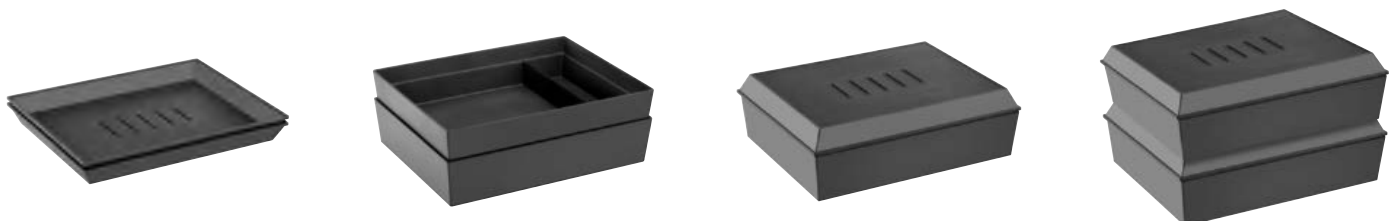



# Melamine!

- Modern design with matt-black surface
- Dishwasher-safe
- Food-safe
- Odourless
- Easy-care



Real added value is provided by different boxes made from the same material. They are available as an insert for the bento box (page 122) and as a cutlery box in two sizes. In addition, three smaller variants have been developed, paying particular attention to the greatest possible compatibility with the trays. The boxes can be arranged in a variety of combinations on all melamine trays and thus offer enormous potential for a use at the Flying Buffet, in catering, at the bar or at the breakfast buffet. A selection of suitable combinations is available on the following pages.

The sturdy containers can also be used as plain elevations for platters and trays. Without additional efforts in procuring material, it is possible to arrange varied buffet presentations quickly and easily. Additionally available are different versions with three round or oval cavities. A big selection of suitable inserts made of glass or porcelain is available on page 262 and 263.

The spoon rest made of melamine is available on page 128, suitable spoons and skewers on pages 134 and 135.



## bowl/box

melamine, black, surface matt, food-safe, dishwasher-safe, not suitable for microwave and combi steam oven

item	l x w x h in cm	content in l	PU
4598.09	9x6.3x4.5	0.25	6 pcs
4598.13	12.8x9x4.5	0.35	4 pcs



## bowl/box

melamine, black, surface matt, food-safe, dishwasher-safe, not suitable for microwave and combi steam oven

item	l x w x h in cm	content in l	PU
4599.13	12.8x12.8x4.5	0.51	4 pcs



## insert/box

melamine, black, surface matt, stackable, food-safe, dishwasher-safe, not suitable for microwave and combi steam oven, up to 4 pieces fit into item 4578

item	l x w x h in cm	content in l	PU
4580	29.5x9x3.3	0.55	3 pcs



## cutlery/napkin box

melamine, black, surface matt, food-safe, dishwasher-safe, with 4 rubber feet, not suitable for microwave and combi steam oven, for cocktail napkins folded to 1/8

item	l x w x h in cm	content in l	PU
4591	16x6x4.5	0.26	2 pcs



## cutlery box

melamine, black, surface matt, food-safe, dishwasher-safe, not suitable for microwave and combi steam oven, for cutlery with a length of up to 23.5 cm

item	l x w x h in cm	content in l	PU
4594	26.5x16.2x7.2	2.25	4 pcs



**tray**

melamine, black, surface matt, food-safe, dishwasher-safe, not suitable for microwave and combi steam oven

item	l x w x h in cm	PU
4586	25.2x13.2x1.8	2 pcs



**GN tray**

melamine, black, surface matt, food-safe, dishwasher-safe, not suitable for microwave and combi steam oven

item	l x w x h in cm	GN	PU
4587	32.5x17.6x1.8	1/3	2 pcs
4588	32.5x26.5x1.8	1/2	2 pcs
4589	53x32.5x1.8	1/1	2 pcs

The "Modul" base trays made of walnut are available on page 130 and 131, suitable inserts made of glass and china on pages 134 to 136.



**base tray "Modul"**

melamine, black, surface matt, food-safe, dishwasher-safe, not suitable for microwave and combi steam oven

item	l x w x h in cm	PU
4581	53x28x1.8	2 pcs
4582	72.5x28x1.8	2 pcs
4583	95.5x28x1.8	2 pcs

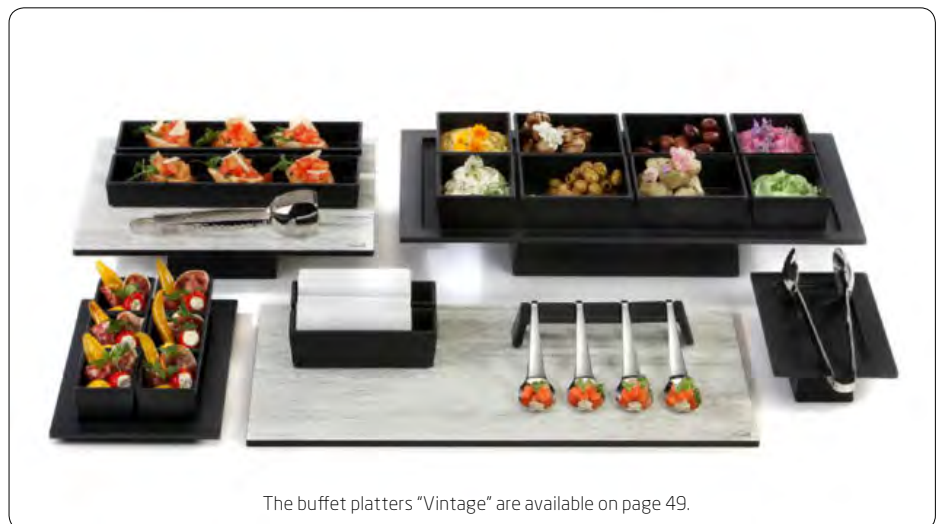

The buffet platters "Vintage" are available on page 49.

**Robust and elegant - melamine!**

The advantages of melamine, such as dishwasher-resistance and food-safety, are particularly evident in daily catering use.

The matt black surface of the Zieher melamine articles generates a superb contrast to glass and porcelain and impresses by its pleasant haptics.

Modern design and the simple language of form of the trays, which are available in common GN formats, make up a pleasant addition to the articles of the "Modul" series (page 134). The bridges and spoon rests (page 128) can be used on all trays, non-skid rubber feet on the bottom side facilitate the service enormously.





# Robust & elegant - melamine!



The boxes can be arranged in a variety of combinations on all melamine trays and thus offer enormous potential for a use at the Flying Buffet, in catering, at the bar or at the breakfast buffet. A small range of possible combinations is shown here, all melamine trays and inserts shown on this double-page are available on page 124 and 125.



4583 + 4598.09 + 4598.13



4583 + 4598.09 + 4598.13



4582 + 4598.13



4582 + 4598.09 + 4598.13



4581 + 4598.13



4582 + 4598.09 + 4598.13



4581 + 4598.09 + 4598.13



# Robust & elegant - melamine!



Inserts made of glass and china, suitable for item 4590, are available on page 263.



## 2/8 GN tray

melamine, black, surface matt, food-safe, dishwasher-safe, not suitable for microwave and combi steam oven, with 3 round sockets (Ø 5.5 cm / 8.2 cm)

item	l x w x h in cm	PU
4590	32.5x13.2x1.8	2 pcs



## glass bowl

clear glass, oval

item	l x w x h in cm	content in l	PU
5444	12.5x7x4	0.08	6 pcs



## bowl

china, white, oval

item	l x w x h in cm	content in l	PU
4081.12	12.5x7.5x4	0.1	12 pcs



## 2/8 GN tray

melamine, black, surface matt, food-safe, dishwasher-safe, not suitable for microwave and combi steam oven, with 3 oval sockets (diagonal), for small bowls items 4081.12 (china) and 5444 (glass)

item	l x w x h in cm	PU
4593	32.5x13.2x1.8	2 pcs



4593 + 4081.12



4593 + 5444



The trays of the "Modul" series and suitable inserts made of glass and china are available on pages 132 to 136.

The party spoons items 1938... are available on page 134.



## bridge "Modul"

melamine, black, surface matt, food-safe, dishwasher-safe, not suitable for microwave and combi steam oven, 5 graded sockets (Ø top 5 cm, Ø bottom 2.5 cm), for several glass items (5257, 5405,...), with 4 rubber feet (black)

item	l x w x h in cm	PU
4584	41.5x7.7x6	2 pcs



## spoon rest "Modul"

melamine, black, surface matt, food-safe, dishwasher-safe, not suitable for microwave and combi steam oven, with 4 rubber feet (black)

item	l x w x h in cm	PU
4585	20x5x4	2 pcs

Further trays made of walnut are available on pages 106 to 116.



### servicing tray "Solid"

walnut, food-safe sealed, not dishwasher-safe, stackable, 2 compartments: 30 cm x 30 cm and 30 cm x 8 cm (for cutlery or china/glass bowls), with 4 rubber feet

item	l x w x h in cm
4769	41.7x32.5x6.7



### cutlery box "Solid"

walnut, food-safe sealed, not dishwasher-safe, with acrylic glass lid, with 4 rubber feet, for cutlery with a length of up to 24.3 cm

item	l x w x h in cm
4720	26.5x16.2x8

The cutlery/hapkin box for the table is available on page 235.



The tray "Slope" made of melamine is available on page 228.



More information about the serving tray "Solid" is available on page 232.



The cutlery boxes item 4720 (wood) and 4594 (melamine) are stackable in all commercial transport boxes in format 60 cm x 40 cm.



# "Modul" - walnut

Wood from the European walnut tree, which is one of the most precious and most beautiful types of wood, forms the basis for this series. Both the wood's warm brown colours in different shades and its intensive and distinctive grain make every product a unique item. The high-quality workmanship in combination with the food-safe sealing guarantees long durability, even in everyday use.



The party spoon items 1938... are available on page 134.



Suitable inserts for the bridge "Modul" are available on page 136.



## base tray "Modul"

walnut, food-safe sealed, not dishwasher-safe, stackable

item	l x w x h in cm
4721	47,5x25,5x3,1
4722	70x25,5x3,1
4723	92,5x25,5x3,1



The finger-groove on the bottom side of the tray guarantees safe and simple handling.



## bridge "Modul"

walnut, food-safe sealed, not dishwasher-safe, with 5 graded sockets (Ø top 5 cm, Ø bottom 2.5 cm), with 4 rubber feet

item	l x w x h in cm
4724	42,5x9x6,5



## spoon rest "Modul"

walnut, food-safe sealed, not dishwasher-safe, with 4 rubber feet

item	l x w x h in cm
4725	21x3,2x3,8



## buffet display "Solid"

walnut, food-safe sealed, not dishwasher-safe, bottom side open, can be used as a stand or as a container

item	l x w x h in cm	PU
4767.12	12x12x12	2 pcs
4767.24	12x12x24	2 pcs

## “Modul” - walnut



“Modul” is a flexible product ready for “Flying Buffet” service - and therefore ideally suited for use in the catering area. The slim, oblong format of the base tray, which is available in three sizes, renders the often cumbersome service at crowded standing receptions barrier-free and uncomplicated. The trays can be variably fitted with glass or porcelain parts, a bridge for glasses or a spoon bench for 4 spoons. When using two spoon benches, 4 long skewers can be placed safely on top. Every single piece has been specially developed for this catering system. Trays, bridge and spoon rest are available in 2 variations: The series “Modul” is manufactured from walnut wood, which is probably the most precious of all European hardwoods, and from melamine in a modern matt-black design (pages 132 and 133). Suitable miniatures made of china and glass (pages 134 to 136) can be fitted to all trays! Shapely anti-slip mats made of silicone (page 137) facilitate catering to a great extent.



The buffet stands “Antique” are available on page 42.  
More items made of walnut are available on pages 104 to 119 and 230 to 241.



# "Modul" - melamine

The advantages of melamine are manifold. It is dishwasher-safe and food-safe, which becomes evident in daily catering use! The smallest tray is 53 cm long and is therefore partially compatible with existing GN-systems. All trays are stackable.

Besides the merely technical properties, the flat black trays differ from the variant made of walnut by their modest design and modern appearance.

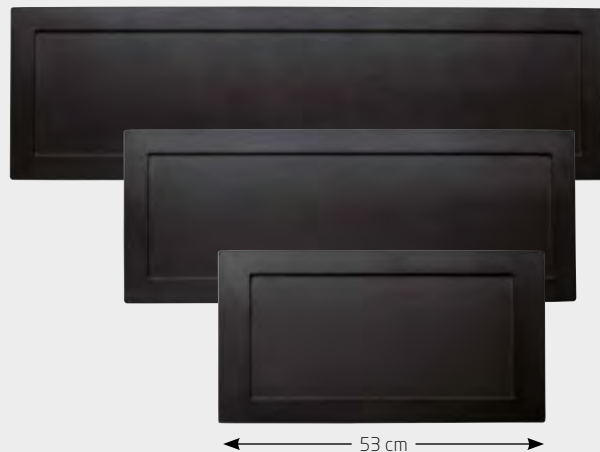

## base tray "Modul"

melamine, black, surface matt, food-safe, dishwasher-safe, not suitable for microwave and combi steam oven

item	l x w x h in cm	PU
4581	53x28x1.8	2 pcs
4582	72.5x28x1.8	2 pcs
4583	95.5x28x1.8	2 pcs



The grooves at the bottom side of the tray let water from the dishwasher run off.



## bridge "Modul"

melamine, black, surface matt, food-safe, dishwasher-safe, not suitable for microwave and combi steam oven, 5 graded sockets (Ø top 5 cm, Ø bottom 2.5 cm), for several glass items (5257, 5405,...), with 4 rubber feet (black)

item	l x w x h in cm	PU
4584	41.5x7.7x6	2 pcs



## spoon rest "Modul"

melamine, black, surface matt, food-safe, dishwasher-safe, not suitable for microwave and combi steam oven, with 4 rubber feet (black)

item	l x w x h in cm	PU
4585	20x5x4	2 pcs



The bowl "Modul" is available on page 134.



The skewers 1939.02 are available on page 135.



The party spoon items 1938... are available on page 134.



Suitable inserts for the bridge are available on page 136.



## "Modul" - melamine

- Modern design with matt-black surface
- Dishwasher-safe
- Food-safe
- Odourless
- Easy-care



The buffet stands "Lightning Buffet" are available on page 44.





walnut



**bowl "Modul"**

china, white, rectangular, deep, for base trays "Modul" made of walnut and melamine

item	l x w in cm	content in l	PU
4384	22x11	0,22	12 pcs



anti-slip mat (page 137)



walnut



**bowl "Modul"**

china, white, square, deep, for base trays "Modul" made of walnut and melamine

item	l x w in cm	content in l	PU
4381	11x11	0,07	12 pcs



walnut



**plate "Modul"**

china, white, square, flat, for base trays "Modul" made of walnut and melamine

item	l x w in cm	PU
4380	11x11	12 pcs

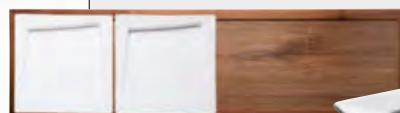

walnut



**plate "Modul"**

china, white, square, flat, item 4385.22 fits base trays "Modul" made of walnut and melamine

item	l x w in cm	PU
4385.22	22x22	6 pcs
4385.27	27x27	4 pcs



walnut

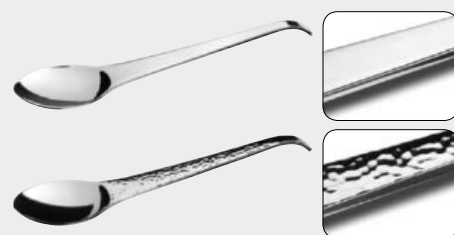

**party spoon**

stainless steel 18/10, 4,3 mm thick, heavy quality, 21 cm long

item	version
1938	polished
1938.01	hammered

# "Modul" - versions

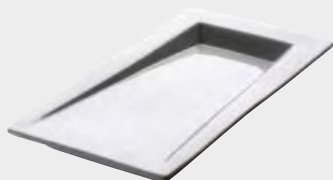

## plate "Modul"

china, white, rectangular, flat, for base trays "Modul" made of walnut and melamine

item	l x w in cm	PU
4383	22x11	12 pcs



## amuse gueule/tapas spoon

china, white

item	l x w x h in cm	PU
4260.01	13x4x3	12 pcs



## amuse-gueule/tapas spoon "Modul"

china, white

item	l x w x h in cm	PU
4260.03	10x4x2.2	12 pcs



## spoon rest "Modul"

melamine, black, surface matt, food-safe, dishwasher-safe, not suitable for microwave and combi steam oven, with 4 rubber feet (black)

item	l x w x h in cm	PU
4585	20x5x4	2 pcs

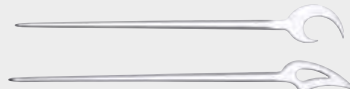

## skewer

stainless steel 18/10, polished, 24 cm long

item	version	PU
1939.01	Moon	12 pcs
1939.02	Flame	12 pcs



## cutlery/napkin box

melamine, black, surface matt, food-safe, dishwasher-safe, with 4 rubber feet, not suitable for microwave and combi steam oven, for cocktail napkins folded to 1/8

item	l x w x h in cm	content in l	PU
4591	16x6x4.5	0.26	2 pcs



melamine



melamine with anti-slip mat (page 137)



melamine

"Modul"





walnut with anti-slip mat

The "Modul" base trays made of walnut and melamine combine well with many Zieher items from the same series and beyond. Here are some suggestions:



### small bowl

china, white, square

item	l x w x h in cm	content in l	PU
3853	7x7x2	0.05	12 pcs



### small bowl

china, square, 4.9 cm long, 4.9 cm wide, 4.5 cm high, 0.05 l content

item	version	PU
3845	china	4 pcs
5254	clear glass	4 pcs



### dip bowl "Twist" for olive oil

china, white, square

item	l x w x h in cm	PU
3912	12x12x1.8	6 pcs



### glass bowl

borosilicate glass, flat

item	Ø / height in cm	content in l	PU
4910	10.5 / 2.5	0.18	12 pcs



### glass miniature

clear glass, for bridges "Modul" items 4584 and 4724

item	Ø / height in cm	content in l	PU
5405	5 / 8.6	0.1	6 pcs



### glass miniature

clear glass, for bridges "Modul" items 4584 and 4724

item	Ø / height in cm	content in l	PU
5257	7 / 10	0.08	12 pcs



### glass miniature

clear glass, wavy rim, base: 0.07 l content, top part: 0.04 l content, for bridge "Modul" items 4584 and 4724

item	version	Ø / height in cm	PU
5423.01	base	6.5 / 5.5	12 pcs
5423.02	top	6.3 / 4.5	12 pcs



### test tube

borosilicate glass (temperature change resistant), with flanged rim and round bottom, for holder for test tube items 4680... and cork item 1501

item	Ø / height in cm	content in l	PU
4032.G	2 / 15	0.04	24 pcs

### cork

for test tube item 4032.G

item	Ø in cm	length in cm	PU
1501	2 / 1.7	2.6	24 pcs



### holder for test tubes

silicone, Ø 4.6 cm, 2.7 cm high, with grooves on the inside for easy insertion of glass tubes, for test tube item 4032.G

item	colour	PU
4680.S	black	6 pcs
4680.W	white	6 pcs

# Non-slip covers in matt black: Classy look - great benefit!



The matt black look and velvety texture of these mats create an interesting contrast when used in connection with the trays made of walnut. In combination with the "Modul" melamine trays they become almost invisible.

The mats made of food-safe silicone are extremely skid-proof and facilitate the serving considerably. No clattering, no shifting of porcelain bothers guests and staff!

To clean the mats, please use a moist cloth with some detergent and wipe off with a cloth and clear water.



Non-slip coasters for single miniatures are available on page 209.



The mats are made to match the size of the walnut trays Art.-Nr. 4721, 4722 and 4723. With a sharp cutter knife they can be adapted to the size of the melamine trays Art.-Nr. 4581, 4582 and 4583. We recommend to use a cutting mat as well as a metal ruler.

## non-slip mat

silicone, black, food-safe, temperature resistant (-40 °C - +230 °C), for walnut trays "Modul" items 4721, 4722 and 4723, can be cut to fit melamine trays "Modul" items 4581, 4582 and 4583

item	l x w in cm	PU
4660.01	42.6x20.6	6 pcs
4660.02	65.1x20.6	6 pcs
4660.03	87.6x20.6	6 pcs





VENTA by Büchin Design has developed an elegant buffet furniture programme for the high demands of the hotel industry and for exclusive events. It is equipped with a number of technical features to keep food hot or cold.

The tables are equipped with castors and can therefore be used very flexible in different rooms. They can be stored under each other or dismantled and stored in trolleys in just a few simple steps.



The modular buffet table system STAGE can be assembled and disassembled in just a few easy steps, without the need for any tools.



All four tables fit in one trolley. The individual parts are safely stored, each part has its own place.

## MODULAR BUFFET SYSTEM

- Adjustable heights
- Movable by castors
- Nesting Storage
- Trolley Transport System



total buffet length: 536 cm



all tables in a row / adjusted at the same height

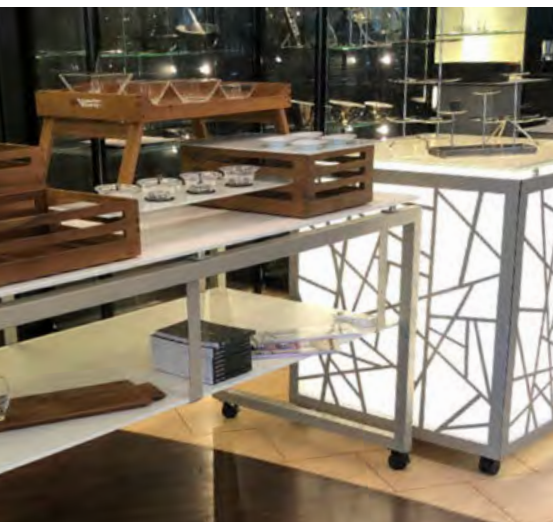

Zieher and VENTA cooperate in the area of buffet presentation.  
The Zieher table-top buffet elements harmonize excellently with the modular buffet system "STAGE" of the VENTA brand.



All details of VENTA system you will find at: [www.ventadesign.com](http://www.ventadesign.com)





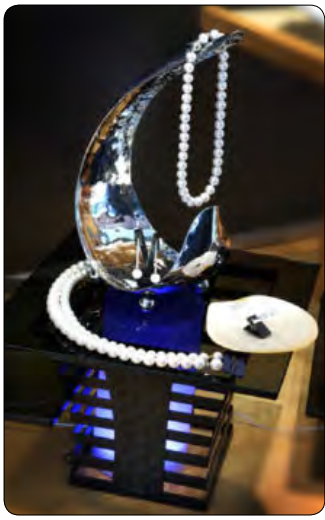

The buffet systems by Zieher were developed to put the most exquisite products into the limelight in a very effective and diversified way.



The section "displays" shows that they are not limited to the use with food: high-class jewellery and watches, as well as other kinds of luxury goods find a representative stage with the Zieher display systems.

The discreet and classy design never pushes for attention, but offers a unique and distinctive means of presentation, that puts the product at the centre of attention.

Contact: [display@zieher.com](mailto:display@zieher.com)



Photo: [www.juwelier-hohenberger.de](http://www.juwelier-hohenberger.de)

China, glass  
and more!





# "Pulsar"



## "Pulsar" - Sparking Impulses!

This gourmet plate, predestined for appetizers, intermediate courses or desserts, excels through its exceptional shape and thrills the beholder by the exotic touch it has been awarded by its designers.

The surface is reminiscent of the playful waves created on a smooth lake after a stone's throw. The viewer's gaze purposefully wanders to the centre of the concentric design and this way, the served dishes come straight to the fore. Be it for selectively arranged sauces or dips, crunchy crisp caramelized nuts or edible flowers, even the wave troughs of the plate's rim offer numerous possibilities to stage dishes effectively. "Pulsar" is made of high-quality hard porcelain in a surprisingly soft composition and is available glazed in glossy white or in matt black.

The fitting cloches are based on the extraordinary design of the "Nostalgic" glasses from the VISION series. The language of design of the wine glasses recurs in the cloches that are mouth-blown as well – the perfect combination for a balanced and harmonic staging on the table. These exclusive covers are available in two sizes: The small version precisely spans the inner circle, the bigger one additionally covers the first wave.



4507.02PB+5482.10



### glass cloche

crystalline glass, transparent, handblown, for a utility space of Ø 9.5 cm or Ø 14.5 cm respectively

item	Ø in cm	height in cm	PU
5482.10	10.5	approx. 13	2 pcs
5482.15	15.5	approx. 19.5	1 pc

### glass cloche

in black gift box

item	Ø in cm	height in cm	PU
5482.10PB	10.5	approx. 13	1 pc



4507.01PB + 5482.15



### plate/platter "Pulsar"

china, white, Ø inside 10.5 cm, suitable for cloche 5482.10 and 5482.15, in black gift box

item	Ø in cm
4507.01PB	29.5



4507.02PB + 5482.10



### plate/platter "Pulsar"

china, black, matt, Ø inside 10.5 cm, suitable for cloche 5482.10 and 5482.15, in black gift box

item	Ø in cm
4507.02PB	29.5



**platter/plate "Pulsar"**

glass, 6 mm thick, dark grey, Ø inside 18 cm, suitable for cloches items 4880.18 and 4880.26

item	Ø in cm
5190	31.5

Due to the reduced waves, this new version made of grey glass offers significantly more space for staging dishes. A stylish extension for more creative latitude!



The glasses of the VISION serie sare available on page 191.



**glass cloche**

borosilicate glass, clear, handblown, handmade, for glass plate "Pulsar" item 5190

item	Ø in cm	height in cm
4880.18	18.5	approx. 29-32
4880.26	26	approx. 41-44

Glass cloches in many different sizes are available on page 173.



# "Cuspis"



## glass cloche "Cuspis"

borosilicate glass, transparent, handblown, star-shaped ball handle

item	for plate/bowl	Ø in cm	height in cm
4940.08	4389.09	8.5	12.5
4940.10	4389.11	10.5	14.5
4940.25	4389.25PB	25	32.5



## plateau plate/small bowl "Cuspis"

china, white, inside and useable area (plateau Ø approx. 6 cm/8 cm) glazed, outside biscuit, also useable as a bowl

item	Ø in cm	height in cm	content in l
4389.09	9	3	0.1
4389.11	11.5	3.5	0.18



The honey spoon "Cuspis", here used as a skewer, is available on page 200.



The dark grey glass platters are available on page 74, the glass spoon "Cuspis" on page 200.



## plateau plate/bowl "Cuspis"

china, white, inside and useable area glazed, outside biscuit, useable on both sides, for cloches items 4940.25 and 4940.10 (bottom side), in black gift box

item	Ø in cm	height in cm	content in l
4389.25PB	25	2.8	0.8



## cloche with plateau plate/ small bowl "Cuspis"

set consists of:

**cloche** made of borosilicate glass, transparent, handblown, with star-shaped ball handle

**plateau plate** made of white china, inside and useable area glazed, outside biscuit, useable on both sides  
1 set in black gift box

item	Ø in cm	height in cm	PU
4943.08PB	9	approx. 14	1 set (2 parts)
4943.10PB	11.5	approx. 17	1 set (2 parts)
4943.25PB	25	approx. 33	1 set (2 parts)

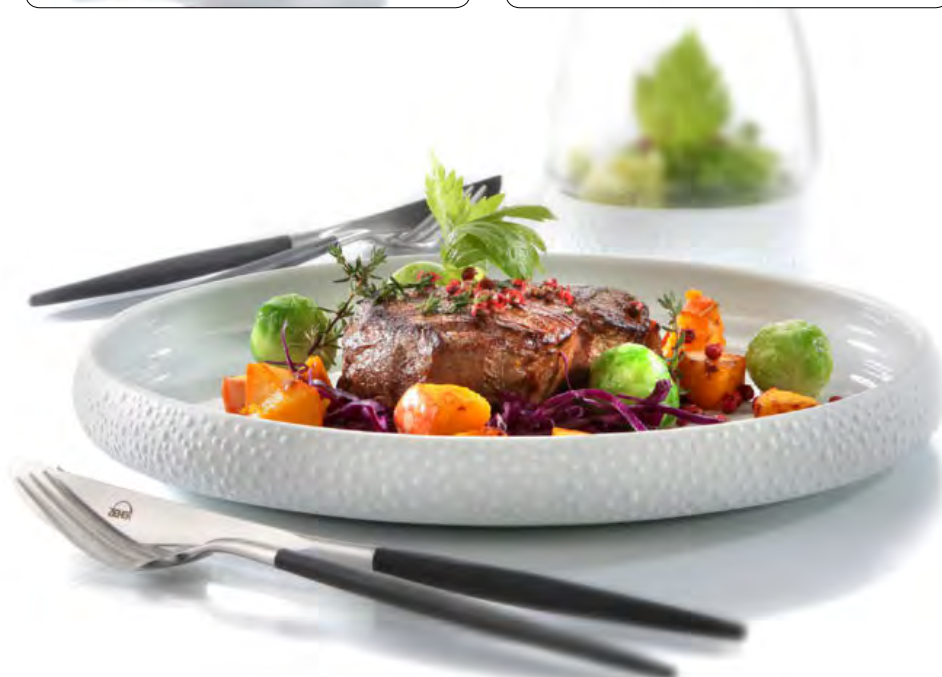

### Borosilicate glass in its most beautiful shape!

The primary design element of the series “Cuspis” is a glass ball studded with fine spikes. The cloches with fitting porcelain plateau plates/ bowls are available in three sizes, the inspiration for their shaping was derived from the nut of the oak tree. The star-shaped handle is located at the top of the cloches and allows for an uncomplicated handling of these classy covers. The unglazed outside of the porcelain bowls is reminiscent of acorn caps. The bowls can be used on both sides. When used as a plateau plate, the dish moves closer to the guest. Used as a bowl, it offers space for gravies, sauces and more while the filigree glass cloche protects the presented delicacies and puts them in the limelight at the same time. Shapely amuse-gueule spoons as well as an extraordinary honey spoon, which can also be used as a skewer, complete the “Cuspis” series. These items are available on page 200.



If the item is used upside down as a plate, the two rings on the plate's underside can be used to separate the prepared dish into different sections, the cloches of the “Cuspis” series may also be used with it (4940.10 on the inner ring, 4940.25 on the outer ring).



4389.25PB + 4940.10



# "Unique"

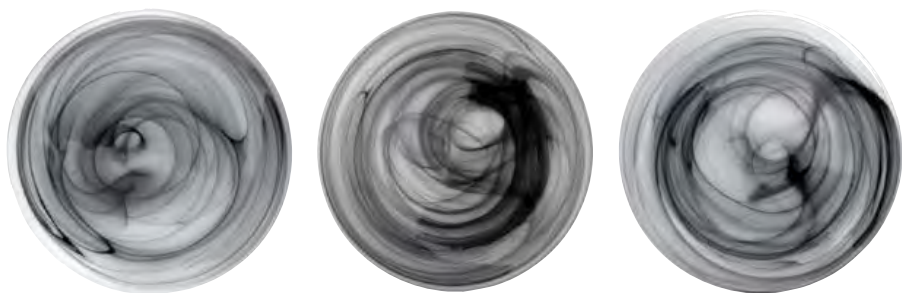

"Unique" is produced in centrifugal casting. Besides the individual decor, this production method entails a slight variation of size, strength and shape of the items. Also, some air inclusions are possible. That's exactly what awards these unique pieces their special charm.



## glass plate "Unique"

glass, white marbled, bottom satined, round

item	Ø in cm	PU
5178.16	16.5	6 pcs
5178.21	21	6 pcs
5178.28	28	6 pcs
5178.32	32	3 pcs



## glass bowl "Unique"

glass, white marbled, outside satined, round

item	Ø in cm	height in cm	content in l	PU
5180.10	10	6	approx. 0.2	6 pcs
5180.15	14.5	7.5	approx. 0.65	6 pcs



## glass bowl "Unique"

glass, white marbled, outside satined, round

item	Ø in cm	height in cm	content in l	PU
5182.16	16	5	approx. 0.67	6 pcs
5182.21	21	8	approx. 2.0	4 pcs
5182.27	26.5	8	approx. 2.75	4 pcs

"Unique"



#### glass plate "Unique"

glass, black marbled, bottom satined, round

item	Ø in cm	PU
5179.16	16.5	6 pcs
5179.21	21	6 pcs
5179.28	28	6 pcs
5179.32	32	3 pcs

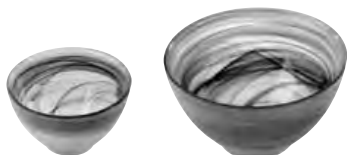

#### glass plate "Unique"

glass, black marbled, outside satined, round

item	Ø in cm	height in cm	content in l	PU
5181.10	10	6	approx. 0.2	6 pcs
5181.15	14.5	7.5	approx. 0.65	6 pcs



#### glass bowl "Unique"

glass, black marbled, outside satined, round

item	Ø in cm	height in cm	content in l	PU
5183.16	16	5	approx. 0.67	6 pcs
5183.21	21	8	approx. 2.0	4 pcs
5183.27	26.5	8	approx. 2.75	4 pcs

The plates and bowls of the "Unique" series are made of clear glass, which is awarded an inimitable character by adding black and white glass components. This creates individual streaks and swirls, which assemble to highly exciting patterns.

All items of this series are available in black or white. The underside of the plates as well as the outside of the bowls are blasted, which results in satined optics and pleasant haptics.

With the black imbued versions, this refinement intensifies the contrast; with the white ones, it appears more restrained by the matting of the backside – the decor retracts in an unobtrusive way. "Unique" presents - in shape and decor - a real counterpart to the uniform character of industrially manufactured mass products and proves to be as unique as its users.



The etagere "DressCoat" is available on page 94.  
 Assembly:  
 2x 5179.21 + 1x 5179.28



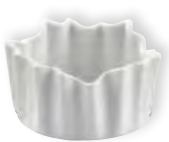

### plateau plate "DressCoat"

china, white, useable area (plateau): Ø 6.5 cm, also useable as a bowl

item	Ø / height in cm	content in l	PU
4386.02	8 / 4	0.09	12 pcs

### plateau plate "DressCoat"

china, white, useable area (plateau): Ø 7.5 cm, also useable as a bowl

item	Ø / height in cm	content in l	PU
4386.01	9 / 4.5	0.1	12 pcs

### plateau plate "DressCoat"

china, white, useable area (plateau): Ø 10.5 cm, also useable as a bowl

item	Ø / height in cm	content in l	PU
4386	13 / 6.5	0.4	6 pcs

### plateau plate "DressCoat"

in black gift box

item	Ø / height in cm	content in l	PU
4386.PB	13 / 6.5	0.4	1 pc

## "DressCoat"



### plateau plate "DressCoat"

white china, useable area (plateau): Ø 15 cm, also useable as a bowl

item	Ø / height in cm	content in l	PU
4387	17 / 8.5	0.85	3 pcs

### plateau plate "DressCoat"

in black gift box

item	Ø / height in cm	content in l	PU
4387.PB	17 / 8.5	0.85	1 pc



### plateau plate "DressCoat"

white china, useable area (plateau): Ø 19.5 cm, also useable as a bowl

item	Ø / height in cm	content in l	PU
4388	22 / 6.5	0.9	3 pcs

### plateau plate "DressCoat"

in black gift box

item	Ø / height in cm	content in l	PU
4388.PB	22 / 6.5	0.9	1 pc



The etagere 2212.30 is available on page 94.

Food: Pâtisserie Walter  
(www.patisserie.de)



"DressCoat" was created by the glass and porcelain designer Nadine Podewski. The elegant language of design is reminiscent of set tables, the creation of the plates and bowls respectively is characterised by the apparently free falling drapery of table cloth. This creates a seemingly weightless, almost floating effect. The slightly concave shaped surface offers space for artfully decorated dishes and reliably avoids the sloshing of sauce.

"DressCoat" is available in five different sizes. Besides the main application as a plateau plate, each item can also be used as a bowl. The falling folds add up to an exciting game of shapes - in particular if used as a bowl.

With "DressCoat" you will dish up delicacies!



4386.01



4386.02





# Bedded on glass, wood...



**glass pillow "Donna"**  
glass, satined, in black gift box

item	l x w x h in cm
5446.01PB	16.5x11x3



The variants of the "Donna" pillows are made of frosted glass and oiled walnut and despite their hard and massive raw materials, they surprise by their pleasantly soft and velvety feel. One just has to touch the softly curved forms of this hand charmer. The version made of solid walnut, one of the finest European types of wood, has its own appearance. The sealing with oils emphasizes the striking grain of the wood and gives the surface a silk-matt gloss as well as amazing haptics. Whether used as a fruit bowl, as a place to keep accessories or as sculptural decoration - "Donna" seduces in every material!



**wooden pillow "Donna"**

solid walnut, oiled, not dishwasher-safe, 4 rubber feet, in black gift box

item	l x w x h in cm
4772.33PB	33.5x22.5x7



...or china!

"Donna"



Design: Wilma Greim



**porcelain pillow "Donna"**

white, item 4461.02 is not dishwasher-safe

item	l x w x h in cm	PU
4461.03	12.3x8x2.7	12 pcs
4461.02	33x22x7	1 pc



Platters and charger plates made of hardened black glass are available on page 50.

The elegant porcelain-pillows "Donna", which are inspired by a woman's curved back, are definitely not made to sleep on, but offer an ideal presentation area for high-end dishes or present a sculptural place to keep various items of everyday life. Even when used as a soap dish, the medium pillow made of glass or porcelain cuts a fine figure. The version made of porcelain is available in two sizes and stages every dish and surprises the guest. Especially the small pillow can be used perfectly on the buffet and offers an exciting contrast to conventional forms of glass or china.



**plate "Velo"**

china, white, surface glazed, underside biscuit

item	l x w x h	PU
4505	27x20x2.8	3 pcs



Design: Itamar Harari



**plate "Velo"**

china, black, matt, surface glazed, underside biscuit

item	l x w x h in cm	PU
4505.01	27x20x2.8	3 pcs



"Velo"



# "Collina"



## glass bowl/cloche

clear glass, handblown, for platter "Collina" item 4503

item	Ø / height in cm	content in l	PU
5418	9/6	0.2	6 pcs



## glass

clear glass, for platter "Collina" item 4504

item	Ø / height in cm	content in l	PU
5380	7.5 / 10.5	0.32	6 pcs
5381	7.5 / 6	0.18	6 pcs



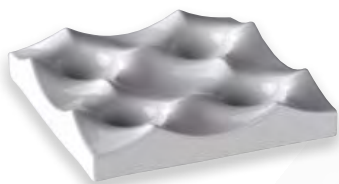

**platter "Collina"**

china, white, not dishwasher-safe, with 4 deepenings, with 4 rubber feet (enclosed in the pack)

item	l x w x h in cm
4503	24.5x24.5x4.5

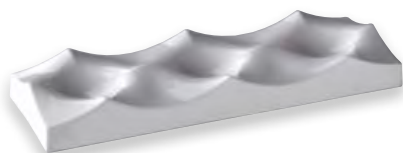

**platter "Collina"**

china, white, not dishwasher-safe, with 3 deepenings, with 4 rubber feet (enclosed in the pack)

item	l x w x h in cm
4504	36.5x12.5x4.5

**platter "Collina"**

in black gift box

item	l x w x h in cm
4504.PB	36.5x12.5x4.5

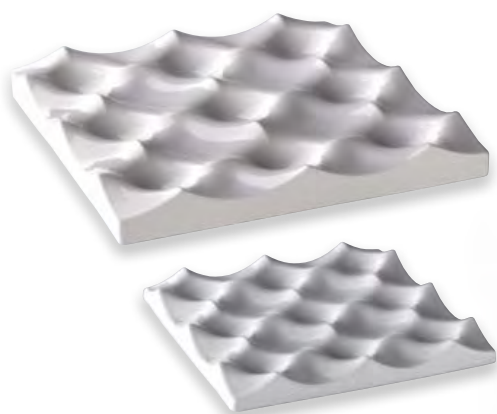

**platter "Collina"**

china, white, not dishwasher-safe, with 9 deepenings, with 4 rubber feet (enclosed in the pack)

item	l x w x h in cm
4501	36.5x36.5x4.5
4502	26x26x3.2

**platter "Collina"**

in black gift box

item	l x w x h in cm
4501.PB	36.5x36.5x4.5



"Collina" provides almost unlimited possibilities. Whether in the lobby or on the buffet, for the presentation of fruit and pastry or as an exclusively decorative element, this series is versatile. The smaller version of the plate, which is divided into nine parts, is perfectly suitable for various antipasti and delicacies from the patisserie. A selection of fruit can be put in the limelight beautifully by using platters with either three or four deepenings.

The possibilities when considering private use are numerous, too. "Collina" may be used as a fruit bowl, but it is also suitable as a means to neatly organize objects of everyday life, such as the mobile phone or keys.

In order to protect the sensitive surfaces of furniture, every plate comes with feet made of rubber, which can be stuck on if needed. The rigorously geometrical structure permits the assembling of several plates, which allows to enlarge the effective area of the platters in both length and width. When looking at the surface from the side, the arrangement has the appearance of a desert landscape arbitrarily formed by the wind.



homesolute  
award 2012



# "Dots"



## plate "Dots"

china, white, underside biscuit, surface glazed, nubby on one half for the safe placement of miniatures

item	l x w x h in cm	PU
4506	30x18.5x2.2	3 pcs



## small bowl

china, white, rectangular

item	l x w x h in cm	content in l	PU
3858	13.5x6.5x2	0.07	12 pcs



## small bowl

china, white, square

item	l x w x h in cm	content in l	PU
3859	6.5x6.5x2	0.03	12 pcs



## small glass bowl

clear glass, square, delivery without lid item 5338.01 (please order separately)

item	l x w x h in cm	content in l	PU
5338	7x7x3.9	0.1	12 pcs

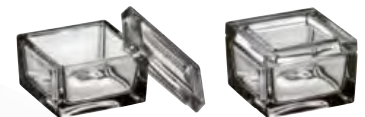

## glass miniature

clear glass, square, lid for small glass bowl item 5338

item	l x w in cm	PU
5338.01	7x7	12 pcs



## small bowl

clear glass, square, delivery without lid item 5254.01 (please order separately)

item	l x w x h in cm	content in l	PU
5254	4.9x4.9x4.5	0.05	4 pcs

Aside from being decorative elements, the nubs on the surface of the "Dots" plate are a simple and functional means to place miniatures made of glass and porcelain safely. The separation of liquid and solid, hot and cold food can be realized in an easy and visually appealing way.

No matter if it is used for sushi, desserts or Fine Dining, "Dots" is ideal for lots of applications!



## glass miniature

clear glass, lid for small glass bowl item 5254 and glass creamer item 5255

item	l x w in cm	PU
5254.01	4.9x4.9	12 pcs

## small glass creamer

clear glass, square, delivery without lid item 5254.01 (please order separately)

item	l x w x h in cm	content in l	PU
5255	4.9x4.9x4.5	0.05	4 pcs



# "Cave"

Like the shell hides the pearl, the porcelain bowl "Cave" conceals precious delicacies within its hard shell. At first sight, this porcelain piece only partly reveals its interior. "Cave" consists of intricately worked hard porcelain and captures by its soft shape and the velvety haptics of the unglazed outside. Touching the cave-shaped bowl, it feels almost like a palm stone made of white gold, having a soft appearance with delicious contents.



## bowl "Cave"

biscuit china, white, inside glazed, opening: Ø approx. 8 cm, in black gift box

item	Ø in cm	height in cm	PU
4375.01PB	approx. 11	7	1 pc

"Cave" is predestined for an use at cocktail and hors d'oeuvres receptions or at the flying buffet. The miniature bowl can be carried comfortably and perfectly fits in the palm of the hand.

## Stay cool!

Serving chilled food is primarily a technical challenge with certain dishes or intermediate courses. With Zieher's two-coloured cooling pads, this necessity can be met in a sophisticated way, also in terms of visual appearance. The wrapper made of black respectively white nylon fabric appears classy and unobtrusive. The pads are filled with gel which remains shapeable, even when frozen and thus allows an adjustment to the tableware used.



The cooling pads are also applicable on the buffet. More information is available on page 40 and 41.



## cooling pack

nylon, black/white, non-toxic cooling gel

item	l x w in cm
5663.20	20x20

The glass version of the "Cave" bowl is available in two sizes. The soft tinge of this grey glass, which is manufactured in a traditional hand-blowing process, stages the content of these shapely objects.

They offer the fitting framework for fruit, nuts and nibbles as well as for tastefully arranged pasta or salad on a solemnly decorated table. The content of the bowls remains protected by the shell of glass, the amply dimensioned opening seduces to snap at a chance. These unique items also enthuse as a place to keep all kinds of accessories.



## glass bowl "Cave"

dark grey, round, handblown, ground edge

item	Ø in cm	opening Ø in cm	height in cm
4815.18	approx. 18	approx. 14	approx. 11.5
4815.24	approx. 24	approx. 19	approx. 16.5



Design: Wilma Greim



# "Catering de Luxe"



## bowl "Catering de Luxe"

china, white

item	Ø / height in cm	content in l	PU
4281.01	12/6.5	0.25	12 pcs
4281	14/7.5	0.35	6 pcs
4281.02	19/10	1.0	6 pcs
4281.03	24/12.5	2.0	2 pcs
4281.04	28/14.5	3.5	2 pcs



## fondue-Set, 2 parts

china, white, for tealights  
 upper part: Ø 6.3 cm, 7 cm high, 0.14 l content  
 lower part: Ø 6.3 cm, 7 cm high

item	total height in cm	PU
4359	13.5	6 pcs



## small skewer "Flame"

stainless steel 18/0, matt

item	length in cm	PU
1939.04	9.5	24 pcs

# SELECTION A.

"SelectionA." gives creative chefs the opportunity to present their food in many different ways in order to leave a mark on their guests, both by taste and looks. The dish moves closer to the guest and single parts almost seem to be floating freely in the room. The diversity of variations of this series, when combined with other items, is nearly unlimited.



The series consists of different plates and bowls made of porcelain. So-called charger plates are available in two versions, which can be used on their own or in combination with various attachments. These form the basis of the system. Shapely rings made of silicone - available in two sizes, in black or white - allow for a piling of different accessories and are completely slip-proof. Surfaces are matt structured and form an interesting contrast to the shiny gloss of the porcelain. These pieces can be consciously used as design elements or, as well, be assembled almost invisibly. There are no limits to the chef's imagination.

A third ring outside the series (page 212) has been designed to hold test-tubes, the ribbed surface structure ensuring easy insertion of the tubes.





**1 charger plate "SelectionA."**  
china, white, with plateau (Ø 9.5 cm)

item	Ø in cm	PU
4491	28	3 pcs



**2 charger plate "SelectionA."**  
china, white, with hollow (Ø 11 cm, 0.15 l content)

item	Ø in cm	PU
4492	28	3 pcs



**3 plate "SelectionA."**  
china, white, with hollow (4493.19: Ø 6.2 cm, 0.05 l content, 4493.24: Ø 9 cm, 0.14 l content)

item	Ø in cm	PU
a) 4493.19	19	6 pcs
b) 4493.24	24	6 pcs



**4 plate "SelectionA."**  
china, white, oval

item	l x w in cm	PU
4495	25x12	6 pcs



**5 ring "SelectionA."**  
silicone, Ø 8.3 cm, for inlaying/stacking of the china series "SelectionA."

item	colour	PU
a) 4681.S	black	6 pcs
b) 4681.W	white	6 pcs



**6 ring "SelectionA."**  
silicone, Ø 13.4 cm, for inlaying/stacking of the china series "SelectionA."

item	colour	PU
a) 4682.S	black	3 pcs
b) 4682.W	white	3 pcs



**7 glass bowl/cloche**

clear glass, handblown, for ring "SelectionA." item 4681...(please order separately)

item	Ø / height in cm	content in l	PU
5418	9/6	0,2	6 pcs



**8 glass bowl**

dark grey, round, handblown, ground edge, for ring "SelectionA." items 4681...

item	Ø in cm	height in cm	content in l
4814.17	17	5,5	0,3



**9 small glass bowl**

glass, 2 layers, handmade, heavy quality, Ø 7 cm, 4.5 cm high, approx. 0.08 l content

item	colour	PU
a) 4859.07	white	6 pcs
b) 4860.07	black	6 pcs



**10 bowl**

massive stainless steel 18/10, triangular, hammered finish, six times polished

item	Ø in cm	height in cm	content in l
a) 2180.09	9	4	0.08
b) 2180.13	13	6	0.28



**11 bowl**

massive stainless steel 18/10, triangular, smooth finish, six times polished

item	Ø in cm	height in cm	content in l
a) 2182.09	9	4	0.08
b) 2182.13	13	6	0.28

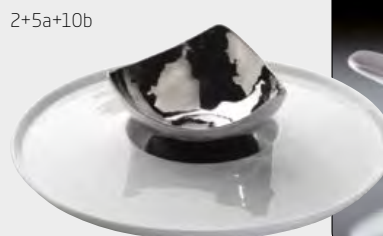



NEW

# "Falcon"

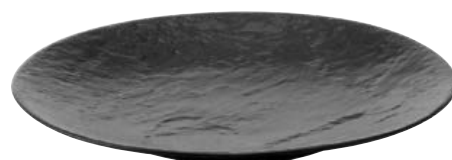

## plate "Rough!"

china, matt black, round, structured surface

item	Ø in cm	PU
4567.24	24	4 pcs

NEW



## coup plate "Catering"

china, matt black, round, flat

item	Ø in cm	PU
3954.235	23	12 pcs



## coup plate "Catering"

china, white, round, flat

item	Ø in cm	PU
3954.21	21	12 pcs

The etagere "Falcon" is available on page 6/7, the double-walled glasses "Amuse" on page 207.





NEW

### napkin ring "Reef"

pewter, real gold coated (18 ct), surface smooth, food-safe, not dishwasher-safe

item	Ø in cm	length in cm	PU
2317G	5,5x3,5	7,5	2 pcs

### napkin ring "Reef"

in black gift box

item	Ø in cm	length in cm	PU
2317GPB	5,5x3,5	7,5	2 pcs 



The glass plates/-tablets in GN format are available on page 165.



Additional items of the „Reef“ collection are available on pages 64-67.

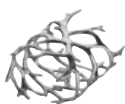

### napkin ring "Reef"

pewter, surface smooth, food-safe, not dishwasher-safe

item	Ø in cm	length in cm	PU
2317	5,5x3,5	7,5	2 pcs

### napkin ring "Reef"

in black gift box

item	Ø in cm	length in cm	PU
2317PB	5,5x3,5	7,5	2 pcs 





# "oro79"



## plate "oro79"

china, golden surface, with foot, not dishwasher-safe, not suitable for microwave and combi steam oven

item	l x w x h in cm
4564.26	26.5x26.5x1.5



## "oro79" is pure luxury

This exclusive miniseries captivates by its extraordinary surface with its golden mother-of-pearl look. A quartered ball allows serving a variety of food in an entirely new way.

"oro79" offers exceptional service for the most demanding guests!

Non-slip coasters are available on page 209, the glass series "Amuse" is available on pages 206 to 208.



## plate "oro79"

china, golden surface, with foot, not dishwasher-safe, not suitable for microwave and combi steam oven

item	l x w x h in cm
4565.35	35x14x1.5



## china ball "oro79"

china, outside golden, 4 parts (3 bowls: 0.5 l / 0.6 l / 0.25 l content + lid), not dishwasher-safe, not suitable for microwave and combi steam oven,

item	Ø in cm	height in cm
4563	15.5	15.8





**charger plate "Ice"**

glass (crimped glass chips), white, round, bevelled edge, dishwasher-safe

item	Ø in cm	height in cm
5760.35	35	2



**charger plate "Ice"**

glass (crimped glass chips), white, square, bevelled edges, dishwasher-safe

item	l x w x h in cm
5761.33	33x33x2



**glass platter "Ice"**

glass (crimped glass chips), white, rectangular, bevelled edges, dishwasher-safe

item	l x w x h in cm
5762.16	16x12x2
5762.33	33x12x2
5762.40	40x15x2

Please note:  
due to the material properties, minor imperfections and air inclusions may occur around the edges.



The absolutely stunning plates of the "Ice" series are made of glass chips which are coalesced and compressed. This procedure allows white and transparent materials to form a most charming pattern. The horizontal look of ice floes paired with the layered structure at the edges brings to mind an ice plate freshly cut from a frozen, wintery lake.



Bevelled edges provide an elegant look as well as easy handling. No matter if it is used as a charger plate or as a sushi plate, for the presentation of a variety of cheese or the staging of desserts, muted colours combined with a clear structure create a perfect basis for stylishly putting artful creations in the limelight.



The cloche item 4880.30 is available on page 176.



# "Modul"

The "Modul" bridge made of walnut and suitable inserts are available on pages 130 and 136.



More party spoons made of china and stainless steel are available on page 226.



## amuse-gueule/tapas spoon "Modul"

china, white

item	l x w x h in cm	PU
4260.03	10x4x2.2	12 pcs



## bowl "Modul"

china, white, square, deep, for base trays "Modul" made of walnut and melamine

item	l x w in cm	content in l	PU
4381	11x11	0.07	12 pcs



## bowl "Modul"

china, white, rectangular, deep, for base trays "Modul" made of walnut and melamine

item	l x w in cm	content in l	PU
4384	22x11	0.22	12 pcs



## plate "Modul"

china, white, square, flat, item 4385.22 fits base trays "Modul" made of walnut and melamine

item	l x w in cm	PU
4385.22	22x22	6 pcs
4385.27	27x27	4 pcs

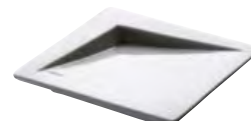

## plate "Modul"

china, white, square, flat, for base trays "Modul" made of walnut and melamine

item	l x w in cm	PU
4380	11x11	12 pcs



## plate "Modul"

china, white, rectangular, flat, for base trays "Modul" made of walnut and melamine

item	l x w in cm	PU
4383	22x11	12 pcs

# Glasplatters/-trays made of black glass



The golden napkin ring of the „Reef“ series is available on page 66.



NEW

## glass platter/tray

glass, structured, dark grey, rectangular, with handles

item	version	l x w x h in cm	PU
5021.01	1/1 GN	53x32.5x2	3 pcs
5021.02	1/2 GN	32.5x26.5x2	4 pcs
5021.03	2/4 GN	53x16x2	4 pcs



## glass tray

glass, deep black, rectangular, for buffet or flying buffet, also functions as a tray

item	l x w x h in cm
5141.34	34x18x2
5141.50	51x35x2



## glass tray

glass, deep black, square, for buffet or flying buffet, functions as a tray or as a charger plate

item	l x w x h in cm
5142.34	35x35x2



## glass tray

glass, deep black, with 3 oval sockets (diagonal, bottom area: 4.7 cm x 8.5 cm), for bowl items 4081.12 (china) and 5444 (glass)

item	l x w in cm
5143	32x14



## glass tray

glass, deep black, with 3 round sockets (bottom area: Ø 6 cm)

item	l x w in cm
5145	32x12





**buffet bowl**

glass, 8 mm thick, dark grey, oblong, structured

item	l x w x h in cm
5703	95x29x10



**glass plate**

glass, 8 mm thick, dark grey, rectangular, with the structure of tree bark

item	l x w in cm	PU
5702	40x22	2 pcs



The glass miniature is available on page 214.



**glass plate**

glass, 8 mm thick, dark grey, oval, with the structure of tree bark

item	l x w in cm	PU
5700	33x24	3 pcs



**glass bowl**

glass, 8 mm thick, dark grey, oval, with the structure of tree bark

item	l x w x h in cm	PU
5701	26.5x19.5x4.5	3 pcs

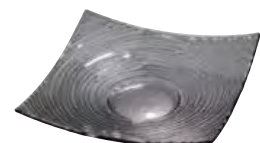

**glass bowl**

glass, 4 mm thick, dark grey, square, structured

item	l x w x h in cm	PU
5016.24	24x24x5	2 pcs





### glass plate

glass, 4 mm thick, dark grey, round, with spiral structure

item	Ø in cm	height in cm	PU
5177.20	20	2,5/4,5	6 pcs
5177.25	25	3/6	6 pcs
5177.28	28	3,5/7	4 pcs



### spoon rest/glass miniature

glass, 4 mm thick, dark grey, with spiral structure

item	l x w in cm	PU
5168.06	approx. 6.5x5	12 pcs



### glass platter/plate

glass, 6 mm thick, dark grey, with spiral structure

item	l x w in cm	PU
5168.14	approx. 14x10.5	6 pcs
5168.25	approx. 25x20.5	6 pcs
5168.30	approx. 30.5x25	4 pcs



### glass platter/plate

glass, 6 mm thick, dark grey, longish, with spiral structure

item	l x w in cm	PU
5169.31	approx. 31x12.5	6 pcs
5169.38	approx. 38x15.5	4 pcs
5169.41	approx. 41.5x12.5	4 pcs



The glass trays are available on page 59.



# Sushi



The glass platters of the "Ice" series are available on page 163.



## chopsticks

borosilicate glass, satined, handmade, please note the safety instructions on each pack (not suitable for children)

item	length in cm	PU
4885	21.5	1 set (2 parts)



## chopstick/knife rest "Flex"

borosilicate glass, transparent, handmade

item	l x w in cm	height in cm	PU
4886	8x2.3	approx. 2.3	2 pcs



GIFT BOX



## chopsticks with rest

set consists of:

**chopsticks**, borosilicate glass, satined, handmade

**rest**, borosilicate glass, transparent, handmade

2 sets in black gift box

item	l x w in cm	l (chopsticks) in cm	PU
4887PB	8x 2.3	21.5	2 sets (6 parts) 



The platter "Dots" is available on page 154.

The black grey glass platter is available on page 166.



More platters made of special hardened safety glass are available on pages 50 to 53.



## charger plate

special hardened safety glass, 4 mm thick, rectangular, rounded edges, polished rim, dishwasher-safe, rubber feet included (adhesive), underside scratch-proof

item	version	l x w in cm
1668.10	black glass	30x18
1670.10	white glass	30x18



## small glass bowl

glass, 2 layers, handmade, heavy quality, Ø 7 cm, 4.5 cm high, approx. 0.08 l content, for sushi platter item 8035

item	colour	PU
4859.07	white	6 pcs
4860.07	black	6 pcs



## sushi plate

granite, anthracite, completely polished, with hole (Ø 5.7 cm) for different inserts of glass, china,...

item	l x w x h in cm
8035	40x15x2.5



## sushi plate

granite, anthracite, completely polished, feet of felt

item	l x w x h in cm
8028	25x25x3



## bowl

granite, anthracite, fully polished

item	Ø in cm	height in cm	content in l
8034	18	7	0.7



The napkin ring of the series "Reef" is available on page 161.







The glass/china bowls are available on page 259.



**glass platter**

glass, structured, transparent, rectangular, four divisions

item	l x w in cm
5084	33x12



The bread/pastry bowl is available on page 84.



**glass platter**

glass, structured, transparent, rectangular

item	l x w in cm
5064	33x12



**buffet platter**

glass, structured, transparent, rectangular, with handles

item	l x w in cm
5075.40	40x25

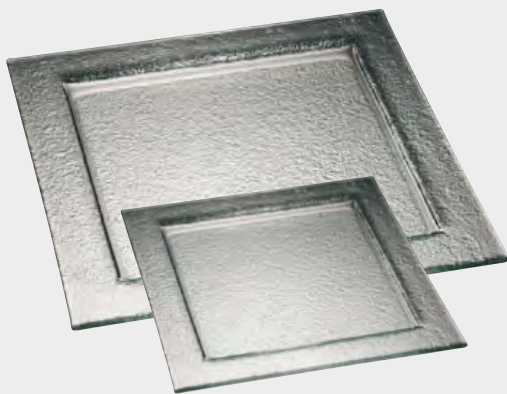

**glass platter**

glass, structured, transparent, square

item	l x w in cm
5063	30x30
5063.50	50x50



**glass bowl**

clear glass, oval

item	Ø / height in cm	content in l	PU
5330.08	7.5 / 3.5	0.08	6 pcs
5330.20	20 / 10	1.1	1 pc
5330.24	24 / 12	2.3	1 pc
5330.29	29 / 14.5	3.3	1 pc



**caviar set**

clear glass, square, big bowl: 14 cm x 14 cm x 8.5 cm, 0.67 l content, small bowl: 8 cm x 8 cm x 4.5 cm, 0.1 l content

item	l x w x h in cm	PU
5347	14x14x10	1 Set (3tlg.)



**glass carafe**

clear glass

item	Ø in cm	height in cm	content in l
5352	9	31	1.0



**glass bowl**

clear glass, square

item	l x w x h in cm	content in l	PU
5308.08	8x8x4.5	0.14	6 pcs
5308.11	11x11x6	0.3	6 pcs
5308.20	20x20x11	1.8	1 pc
5308.26	26x26x12.5	3.5	1 pc

# Making precious materials more precious - whether it is glass or china ...



... everything is possible!

## Large-scale coatings on glass and china in precious colours enrich every dining table and create luxurious accents!

In order to achieve this decorative style, available in gold, platinum and bronze, the precious metals are burnt onto the varnish at more than 880 °C and as a result the coating is dishwasher-safe. Cloches made of glass can now be used for serving warm dishes as well and condensing water remains invisible to a great part.

By using resistant precious alloys, we obtain a connection to the varnish, which is strong enough for the products to become dishwasher-safe. Test series by the "Institut für Werkstoffe Heraeus Precious Metals GmbH & Co. KG" have proven the dishwasher resistance of the decor.

Partially, the possibilities of coating are dependent on the form of the product. Requests are being tested in each case according to their feasibility.

The bronze colour is a special case, since it presents itself in numerous interesting shades of colour. Depending on the shape of the product, especially when looking at immersions, the colours can vary from gold-bronze shades to blue-violet ones which blend into each other and create unique effects.

Specific patterns/orders are usually executed quickly.  
Please do not hesitate to send us your special request!



The complete information on refining stainless steel is available on page 80.

## Please note:

Products are dishwasher-resistant. Please take note of the instructions given by dishwasher producers and detergents in order to avoid damage.

Since the coatings are made of precious metals, the use in microwaves is not recommended under any circumstances.



# "Cuspis"

The cloches and porcelain coasters of the series "Cuspis" are inspired by the nuts of the oak tree. The ball-shaped handle at the tip of the cloches allows for an uncomplicated handling of these classy covers. The unglazed outside of the porcelain coasters with its distinctive texture is reminiscent of acorn caps. The coaster can be used on both sides. When used as a plateau plate, the dishes move closer to the guest, while the filigree glass cloche protects the presented delicacies and puts them in the limelight. Used as a bowl, it offers space for gravies, sauces and more.



If the item is used upside down as a plate, the two rings on the plate's underside can be used to separate the prepared dish into different sections and the cloches of the "Cuspis" series may also be used with it (4940.10 on the inner ring, 4940.25 on the outer ring).

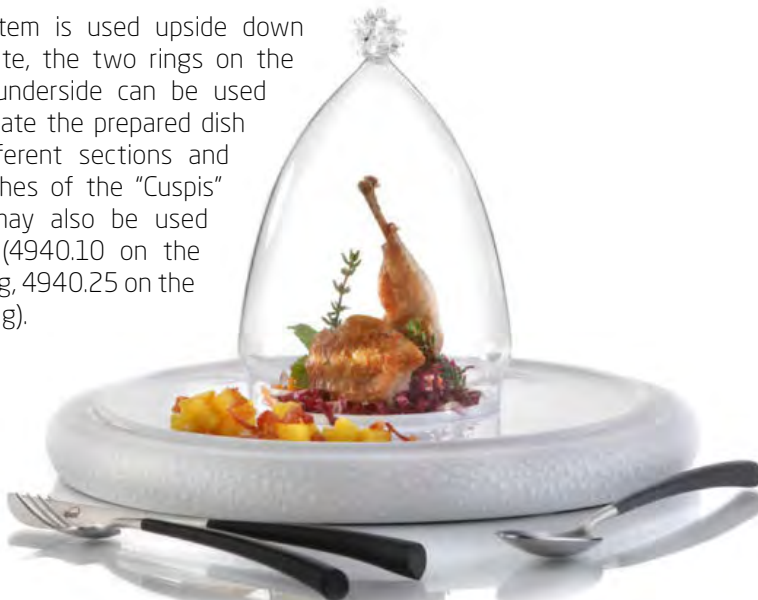

## glass cloche "Cuspis"

borosilicate glass, transparent, handblown, star-shaped ball handle

item	for plate/bowl	Ø in cm	height in cm
4940.08	4389.09	8.5	12.5
4940.10	4389.11	10.5	14.5
4940.25	4389.25PB	25	32.5

## plateau plate/small bowl "Cuspis"

china, white, inside and useable area (plateau Ø approx. 6 cm/8 cm) glazed, outside biscuit, also useable as a bowl

item	Ø in cm	height in cm	content in l
4389.09	9	3	0.1
4389.11	11.5	3.5	0.18



GIFT BOX



## plateau plate/bowl "Cuspis"

china, white, inside and useable area glazed, outside biscuit, useable on both sides, for cloches items 4940.25 and 4940.10 (bottom side), in black gift box

item	Ø in cm	height in cm	content in l
4389.25PB	25	2.8	0.8



GIFT BOX



## cloche with plateau plate/ small bowl "Cuspis"

set consists of:

**cloche** made of borosilicate glass, transparent, handblown, with star-shaped ball handle

**plateau plate** made of white china, inside and useable area glazed, outside biscuit, useable on both sides  
1 set in black gift box

item	Ø in cm	height in cm	PU
4943.08PB	9	approx. 14	1 set (2 parts)
4943.10PB	11.5	approx. 17	1 set (2 parts)
4943.25PB	25	approx. 33	1 set (2 parts)



Cloches

of some other kind!



More sizes and variations of the cloches made of glass are available on the following pages.



Ø 5 cm

Ø 6 cm

Ø 7 cm



**glass cloche**

borosilicate glass, transparent, handblown, handmade

item	Ø in cm	height in cm	PU
4982.05	5	approx. 8-9	6 pcs

**glass cloche**

borosilicate glass, transparent, handblown, handmade

item	Ø in cm	height in cm	PU
4982.06	6	approx. 9.5-10.5	6 pcs

**glass cloche**

borosilicate glass, transparent, handblown, handmade

item	Ø in cm	height in cm	PU
4982.07	7	approx. 11-12	6 pcs



**small bowl**

china, white, deep, oval

item	l x w x h in cm	content in l	PU
4326.11	11x9x3.8	0.1	12 pcs



**miniature plate**

china, white, flat, oval

item	l x w x h in cm	PU
4324.11	11x9x1.8	12 pcs



**small glass bowl**

glass, deep black

item	l x w in cm	PU
5039.01	10x8.5	12 pcs

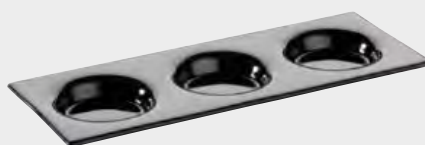

**glass tray**

glass, deep black, with 3 round sockets (bottom area: Ø 6 cm)

item	l x w in cm
5145	32x12

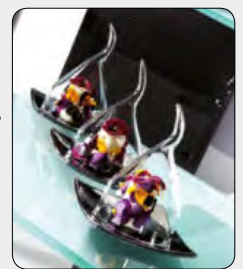

**glass miniature plate**

glass, deep black, flat

item	l x w in cm	PU
5034.01	10x10	12 pcs



Ø 9 cm



### glass cloche

borosilicate glass, transparent, handblown, handmade

item	Ø in cm	height in cm
4982.09	9	approx. 14-16

Ø 11 cm



### glass cloche

borosilicate glass, transparent, handblown, handmade

item	Ø in cm	height in cm
4982.11	11	approx. 17-19

Ø 13 cm



### glass cloche

borosilicate glass, transparent, handblown, handmade

item	Ø in cm	height in cm
4982	13	approx. 20-23



### wind light/smoking cloche

borosilicate glass, with 3 notches at the bottom, open at the top, handmade

item	Ø in cm	height in cm
4987.01	9	approx. 12-13



### plate "SelectionA."

china, white, with hollow Ø 9 cm, 0.14 l content

item	Ø in cm	PU
4493.24	24	6 pcs



### coaster/glass insert

hardened clear glass, 4 mm thick, round, edge polished and deburred, with 4 transparent silicone feet, for coaster "Solid" item 4700

item	Ø in cm	PU
5244	13	6 pcs

refining upon request (page 171)

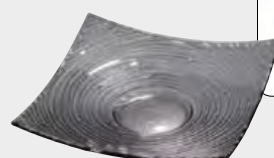

### glass bowl

glass, 4 mm thick, dark grey, square, structured

item	l x w x h in cm	PU
5016.24	24x24x5	2 pcs



### coaster "Solid"

walnut, food-safe sealed, not dishwasher-safe, for glass cloches

item	Ø / height in cm	Ø inner circle in cm
4700.01	15.3 / 2	9.3



### coaster "Solid"

walnut, food-safe sealed, not dishwasher-safe, for glass cloches

item	Ø / height in cm	Ø inner circle in cm
4700	22 / 2	13.3





The glass cloches, which are available in 10 sizes (diameters 5 cm to 30 cm, pages 174 to 176), delight by their high quality and unusual form! The presentation of fine truffles, an exclusive choice of cheese or simply a single praline – there is a fitting size for each purpose!

The lightweight cloches by Zieher are heat resistant, dishwasher safe and very easy to handle for the guests. Each item is manufactured by hand and therefore shaped individually.

The raw material for these items is borosilicate glass, which is mainly used for laboratory dishes. Its main features are a great resistance against heat and changes in temperature as well as a high break resistance. A wine cooler of the same design is available on page 57.



### glass cloche

borosilicate glass, transparent, handblown, handmade, for coaster "Solid" items 4734...

item	Ø in cm	height in cm
4880.18	18.5	approx. 29-32
4880.22	22.5	approx. 35-38
4880.26	26	approx. 41-44
4880.30	30	approx. 48-51



### coaster/glass insert

hardened clear glass, 4 mm thick, round, edge polished and deburred, with 4 transparent silicone feet

item	Ø in cm	for coaster "Solid" item
5244.17	16.7	4734.01
5244.21	20.7	4734.02
5244.24	24.2	4734.03
5244.28	28.2	4734.04



### coaster "Solid"

walnut, food-safe sealed, not dishwasher-safe, stackable, for glass cloche items 4850, 4851, 4852 and 4880... and glass inserts items 5244...

item	Ø / height in cm	for cloches / inlays
4734.01	23 / 3	Ø 18.5 / 16.7 cm
4734.02	27 / 3	Ø 22.5 / 20.7 cm
4734.03	30.5 / 3	Ø 26 / 24.2 cm
4734.04	34.5 / 3	Ø 30 / 28.2 cm

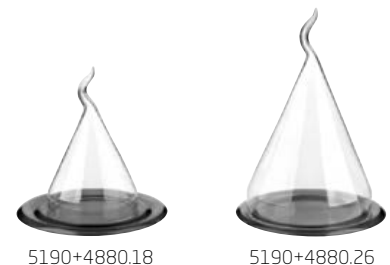

### platter/plate "Pulsar"

glass, 6 mm thick, dark grey, Ø inside 18 cm, suitable for cloches items 4880.18 and 4880.26

item	Ø in cm
5190	31.5



### glass cloche

clear glass, handblown, with round handle, for coaster "Solid" items 4734...

item	Ø in cm	height in cm
4850	18.5	31
4851	22.5	37
4852	26	43



### charger plate, glass

special hardened safety glass, 4 mm thick, round, edge polished, dishwasher-safe, rubber feet included (adhesive), underside scratch-proof

item	version	Ø in cm
1669.33	black glass	33
1671.33	white glass	33



### glass cloche

clear glass, for pastry/cake stand items 5349...

item	Ø in cm	height in cm
5350.16	16	13
5350.23	23	16.5
5350.27	27.5	20.5



### pastry/cake stand

clear glass, with foot

item	Ø in cm	Ø stand in cm	height in cm
5349.21	21	10.5	9.5
5349.28	28	13	11.5
5349.33	33.5	13	11

The saucer "Solid" items 4734... are available on page 176.



Each cloche is handblown and handcrafted. In contrast to our cloches made of borosilicate glass (page 176), these items are made of a massive glass drop. Therefore air inclusions and minor streaks cannot be avoided completely. Each cloche is unique, the result is a harmonic enlivenment of the buffet for an attractive price.



Example of application: Presentation of a premium beer type







Little somethings perfectly staged!

The thick bottom of the hand-blown bowl leads to a blow-up effect when used as a cloche!



### glass bowl/cloche

clear glass, handblown, for ring "SelectionA." item 4681... (please order separately)

item	Ø / height in cm	content in l	PU
5418	9/6	0.2	6 pcs



### ring "SelectionA."

silicone, Ø 8.3 cm, for anti-slip stand of bowl item 5418

item	colour	PU
4681.S	black	6 pcs
4681.W	white	6 pcs



### glass cloche

clear glass, handblown, with handle, for glass stands items 4854... (please order separately)

item	Ø in cm	height in cm
4853	10.5	11.5



### glass stand

clear glass, handblown, with round foot (Ø 8 cm) and platform (Ø 11.5 cm), for glass cloche item 4853

item	height in cm
4854.01	13
4854.02	16.5
4854.03	23



The plates made of china are available on page 218.

The glasses of the series VISION are available on pages 194 and 195, the gourmet plate "Pulsar" on page 142.



## glass cloche

crystalline glass, transparent, handblown, for a utility space of Ø 9.5 cm or Ø 14.5 cm respectively

item	Ø in cm	height in cm	PU
5482.10	10.5	approx. 13	2 pcs
5482.15	15.5	approx. 19.5	1 pc

## glass cloche

in black gift box

item	Ø in cm	height in cm	PU
5482.10PB	10.5	approx. 13	1 pc 

The glass NOSTALGIC of the VISION series is available on page 195.





# Charger plates



More "Capiz" items are available on page 71.

Please note the care instructions: suitable for cold and dry food, not dishwasher-safe.



## charger plate "Capiz"

shell, ivory-coloured, organically shaped, resin-coated, not dishwasher-safe

item	Ø in cm	PU
7100.36	36	2 pcs

NEW



## charger plate, glass

glass, structured, dark grey, rectangular, with handles

item	l x w x h in cm	PU
5021.02	32.5x26.5x2	4 pcs

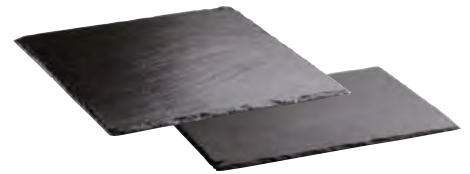

## charger plate, slate

natural slate, approx. 5 mm thick, food-safe (sealed), not dishwasher-safe, with rubber feet

item	version	l x w n cm
2543.30	square	30x30
2544.30	rectangular	30x20



The cloche item 4982.11 is available on page 175.

The complete "Ice" series is available on page 163.



## charger plate "Ice"

glass (crimped glass chips), white, round, bevelled edge, dishwasher-safe

item	Ø in cm	height in cm
5760.35	35	2



## charger plate "Ice"

glass (crimped glass chips), white, square, bevelled edges, dishwasher-safe

item	l x w x h in cm
5761.33	33x33x2



# Charger plates







"DressCoat" is available on pages 148 and 149.



The doublewalled bowl item 4956.01 is available on page 211.



The saucer item 4995 is available on page 208.



### charger plate

hardened clear glass, 6 mm thick, round, rim polished and deburred

item	Ø in cm
4999	33



### charger plate

special hardened safety glass, 4 mm thick, round, polished rim, dishwasher-safe, rubber feet included (adhesive), underside scratch-proof

item	version	Ø in cm
1669.33	black glass	33
1671.33	white glass	33



### charger plate

special hardened safety glass, 4 mm thick, rounded edges, polished rim, dishwasher-safe, rubber feet included (adhesive), underside scratch-proof

item	version	l x w in cm
1668.06	black glass	34x34
1668.10	black glass	30x18
1670.06	white glass	34x34
1670.10	white glass	30x18



### buffet platter

hardened glass, grey transparent, square, irregularly coloured in a cloudy look, underside structured, dishwasher-safe, scratch-proof

item	l x w in cm	thickness in mm
8008.06	34x34	5

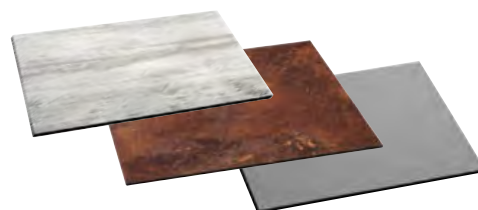

### charger plate

laminated plastic, 8 mm thick, black intermediate ply, break-proof, scratch-proof, dishwasher-safe, antistatic, square, deburred edges, rounded corners

item	version	l x w in cm
8001.06	matured wood-look, white	34x34
8007.06	rusted look	34x34
8006.06	dark grey	34x34

wine glasses  
& more







# "Star" – mini

## Uniqueness in practice

"Many decanters provide a fast but completely unbalanced development of wines because the wines develop only by a macro-oxidation on the surface. It's more balanced and harmonic to implement the necessary oxygen in a very soft and gentle way.

The filigree rays of the centric star animate the served wine to a very soft enhancement. During the slewing, the oxygen is mildly folded in and integrated into the wine. Thus the wine starts to develop on its own terms and not – as with other decanters – just on the surface.

The swirling of the wine is a fascinating view and helps in a three-dimensional development to harmonize the acid and to synchronize different levels of aroma.

By using borosilicate glass as raw material for this decanter, which sticks out by its extremely smooth surface, another highly pleasant effect is that the aromatic molecules aren't expelled from the wine but allowed to present themselves completely in the wine glass. The aerated wine becomes extremely balanced, carefully crafted and centered. An additional value which is simply priceless!"

Silvio Nitzsche, WEIN|KULTUR|BAR Dresden



**Please note:**  
The ideal charge to provide a maximum of oxygen is 0.375 ltr.



### decanter/carafe "Star" - mini

borosilicate glass, transparent, handblown

item	Ø in cm	height in cm	content (bowl) in l
4945	11.5	24	approx. 0.7

### decanter/carafe "Star" - mini

borosilicate glass

item	Ø in cm	height in cm	content (bowl) in l
4945.PB	11.5	24	approx. 0.7 



### decanter/carafe "Star" - mini with VISION "Straight"

set consists of:

#### 1 decanter/carafe "Star" - mini

borosilicate glass, Ø 11.5 cm, height 24 cm, content bowl approx. 0.7 l

#### 2 wine glasses VISION "Straight"

crystalline glass, transparent, handblown, Ø 9 cm, height 27 cm, content 540 ml

1 set in black gift box

item	PU
4946.PB	1 set (3 parts) 



The small "Star" - mini is particularly suitable for the decantation of open wines or small bottles. The ideal charge to provide a maximum of oxygen is 0.375 ltr. The reduced size allows to decant white wines and still to temper them in wine coolers. Also for dessert wines, the staging of innovative high-end cocktails, flavoured spirits, to the point of exotic juices – this unique product is the perfect solution.

# "Star" - the art of decanting

NEW



## decanter/carafe "Star"

borosilicate glass, transparent, handblown

item	Ø in cm	height in cm	content (bowl) in l
4947	15.5	32	approx. 1.8



## decanter/carafe "Star" with base

set consists of:

### 1 decanter/carafe "Star"

borosilicate glass, Ø 15.5 cm, height 32 cm, content bowl approx. 1.8 l

### 1 base ring

silicone, black, Ø 13.4 cm  
1 set in black gift box

item	PU
4948.PB	1 set (2 parts)



## decanter dry rack "Stablo"

stainless steel 18/10, polished, 8 mm thick, with 6 anti-slip rubber caps, suitable for decanters "Eddy" item 4883, "Star" item 4947 and "Pebble" item 4890

item	Ø top/bottom in cm	height in cm	PU
8014.20PB	15/23	20	1 pc

The decanter "Star" synergizes the aesthetics of an unique copy with the functionality of a professional tool for vinophile pleasure.

Created by glassblower Detlef Greiner-Perth and presented by Silvio Nitzsche, "Star" is possibly the most fascinating wine carafe in a long time, due to its exceptional design.

The individual star raises each carafe to an exceptional piece and forms a fascinating basis for discussion with interested guests. This artistically designed centerpiece becomes a unique element in a complex process due to numerous processing steps. This is pure luxury in our uniform world because not a single "Star" is like another.

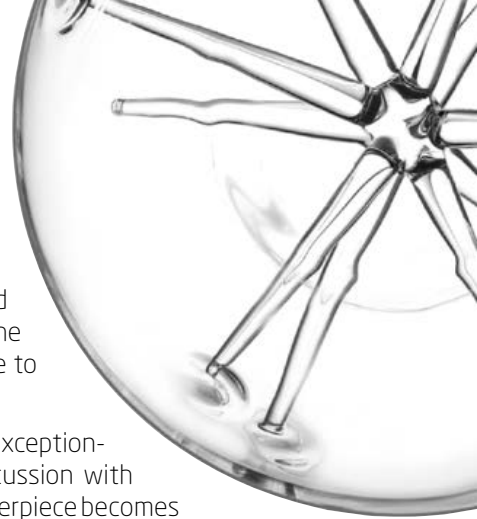

The wine glass series VISION is available on pages 191-197.

Idea: Detlef Greiner-Perth

The big "Star" has a recessed grip in the bottom, which on the one hand improves the swirl during filling and slewing, on the other hand it ensures good handling and a secure hold when serving the wine. The collar, which is included in the gift box, is made of matt black silicone and also allows an inclined positioning.

recessed grip at the bottom for better handling!





## Care instructions decanter:

Looking at "Star" and "Eddy", almost everybody who already gained experience with decanters, will intuitively ask how to clean them. Many decanters have the nature, in particular when used for red wines, to absorb the colour pigments and to show light grey or brown surface layers after a certain usage. Most of these carafes have microscopically seen a rough surface, which leftovers of the wine might adhere to and cause an unattractive appearance of the decanters. With our decanters made of borosilicate glass, this effect might appear after a much longer period due to the extremely smooth and repellent surface of this high-quality laboratory glass. In case it actually happens, these traces can easily be removed by using a mixture of citric acid and water. After a 2 hours residence time, the problem should be solved. The optionally available drying rack (suitable for decanters "Pebble", "Eddy" and "Star") made of highly polished stainless steel, facilitates the drying of the decanters after rinsing (page 185). Non-skid caps, made of matt black silicone, ensure a safe stand and keep the decanter in the desired position.



# Spot on! – basic ring with LED-light



This new version of the basic ring for the “Eddy” (item 4883) and “Star” (item 4947) decanters offers the chance to stage served wine through light.

The rechargeable Zieher LED-light (item 8150) fits exactly into the cavity at the bottom part of the ring and thus can put the served wine inside the decanter into the limelight. In the beginning, the illumination effect in the filled decanter can be very unobtrusive when serving strongly pigmented red wine. But at a decreasing level, the play of light and colours becomes more and more intense in an exciting way. These accessories are also suitable to illuminate glass bowls and – platters. In combination with the ring, the LED-light and remote control still maintain their known options, such as adjustable brightness, 7 different colours and various colour-changing functions. Detailed information about the Zieher rechargeable LED-light can be found on page 45. All components (ring, light, remote control and charger) are available either as single parts or as a set in a gift box.

Attention: The chargers in the gift box are equipped with a EU plug, chargers with US resp. UK plugs are available upon request.



## pedestal/ring, illuminable

silicone, black, optionally available pedestal for positioning the decanter “Star” item 4947 and “Eddy” item 4883 at an angle, suitable for rechargeable LED-light item 8150

item	Ø in cm	height in cm
4679.S	15.2	5.5



## basic ring with LED-light

set consists of:  
**ring made of silicone, black**  
**rechargeable LED-light** incl. charging device EU and remote control  
 1 set in black gift box

item	PU
8153.01PB	1 set (4 parts)

Please find here a detailed description of the rechargeable LEDs in PDF format.





NEW

## "Eddy" - mini

The small "Eddy" - mini is perfectly suitable for the decanting of wines by the glass or little bottles. Thereby the ideal charge to maximise the content of oxygen is 0.375 ltr. The compact design is perfectly suitable to decant white wines first and then to temper in a wine cooler. By the extravagant character of these design elements, even high end cocktails and other exotic creations can be staged appropriately.

**Please note:**  
The ideal charge to provide a maximum of oxidation is 0.375 ltr.



### decanter/carafe "Eddy" - mini

borosilicate glass, transparent, handblown

item	Ø in cm	height in cm	content (bowl) in l
4891	12	25	approx. 0.8

### decanter/carafe "Eddy" - mini

borosilicate glass, transparent, handblown

item	Ø in cm	height in cm	content (bowl) in l
4891.PB	12	25	approx. 0.8 

The basic material for this development worker for wine is extremely robust, high-grade borosilicate glass. This type of glass, which stands out due to its dense structure, extraordinary transparency and hardness, is the precondition for the implementation of the introversive swirl elements. In an interplay with light and the contained wine, they also create visually interesting colour reflections and almost graphic effects.

4891.PB



GIFT BOX



### decanter/carafe "Eddy"-mini with VISION "Straight"

set consists of:

- 1 decanter/carafe "Eddy" - mini**  
borosilicate glass, Ø 12 cm, height 25 cm, content bowl approx. 0.8 l
- 2 wine glasses VISION "Straight"**  
crystalline glass, transparent, handblown, Ø 9 cm, height 27 cm, content 540 ml  
1 set in black gift box

item	PU
4892.PB	1 set (3 parts) 

4884.PB

Design: Silvio Nitzsche

# "Eddy" - the wine development worker



## decanter/carafe "Eddy"

borosilicate glass, transparent, handblown

item	Ø in cm	height in cm	content in l
4883	17	33	approx. 2,3

"The decanter "Eddy" defines the world of extreme wine instruments in a completely new way. Their functionality has seldom been united with an aesthetic language of design in such a spellbinding way. The matchlessly fast-paced development of structure, which all wines undergo in that respirator, is really fascinating! Once rotating in this texture stimulator, due to the thousand-fold swirls at the conical indentations, the wine goes through a process, whose behavior is equivalent to an oxidation reaction of several hours, within a few seconds."



Silvio Nitzsche - WEIN | KULTUR | BAR - Dresden



## pedestal/ring

silicone, Ø 13,4 cm, optionally available pedestal for positioning the decanter "Eddy" (item 4883) and "Star" (item 4947) at an angle

item	colour	PU
4682.S	black	3 pcs
4682.W	white	3 pcs

The volume of the big "Eddy" has been dimensioned in a way that, with a filling of up to 1.5 litres, the extension of the wine's surface becomes as large as possible. Due to the flattened bottom, this respirator stands safely and straight, the collar, which is included in the gift box, is made of matt black silicone and also allows an inclined positioning.



## decanter/carafe "Eddy" with ring

set consists of:

**decanter** made of borosilicate glass, transparent, handblown, approx. 2,3 l content

**ring** made of silicone, black,  
1 set in black gift box

item	Ø in cm	height in cm	PU
4884.PB	17	35	1 set (2 parts)



## decanter dry rack "Stablo"

stainless steel 18/10, polished, 8 mm thick, with 6 anti-slip rubber caps, suitable for decanters "Eddy" item 4883, "Star" item 4947 and "Pebble" item 4890

item	Ø top/bottom in cm	height in cm	PU
8014.20PB	15/23	20	1 pc



For further information about „Eddy“ please have a look at:  
[www.zieher.com/en/highlights/eddy](http://www.zieher.com/en/highlights/eddy)





# "Pebble"



Design: Itamar Harari

While filling the decanter the wine flows, due to the shaping of the neck, along the complete inside area, which maximizes the surface of the wine and thus contributes to the aeration.

The three swales at the bottom serve to further swirl the poured wine, which results in a gentle but nevertheless very effective aeration. This effect can be intensified by warily swinging the filled decanter. Furthermore, the three bulges at the bottom provide a wobble-free and safe stand.

The diagonal cut of the neck and the accurate polishing of the raw edges minimize the formation of drops while pouring out.

The optionally available drying rack made of solid stainless steel, facilitates the drying of the decanters after rinsing. Non-skid rubber caps ensure a safe stand.

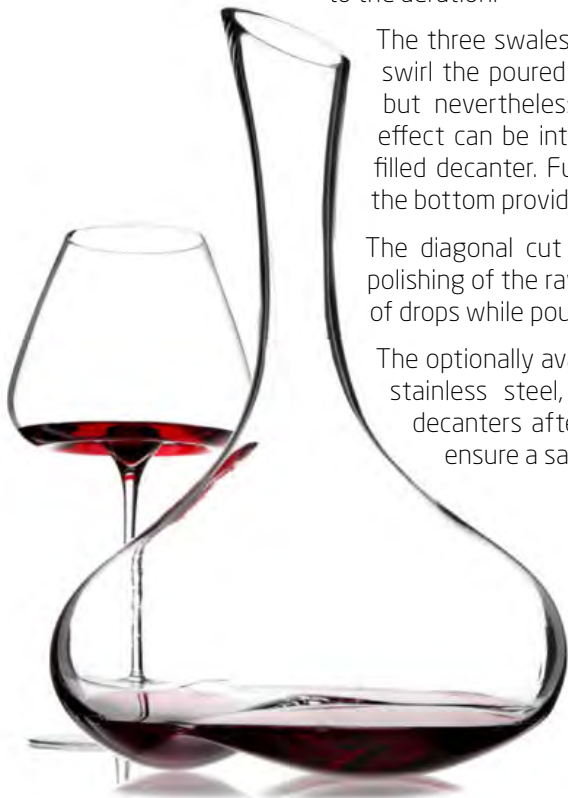

"Pebble" is made of high-grade, lead free crystal glass.

The unfilled decanter inspires by the brilliance of the glass alone and the resulting light reflections.

These products are hand-blown with perfect craftsmanship. The sensitivity and long-year experience of the glass blowers become apparent in particular in the creation of the bottom, which is extensively dimensioned and separated into three convex segments.



## decanter/carafe "Pebble"

crystal glass, transparent, handblown

item	Ø in cm	height in cm	content in l
4890	20	30	approx. 1.8

## decanter/carafe "Pebble"

in black gift box

item	Ø in cm	height in cm	content in l
4890.PB	20	30	approx. 1.8 



## decanter dry rack "Stablo"

stainless steel 18/10, polished, 8 mm thick, with 6 anti-slip rubber caps, suitable for decanters "Eddy" item 4883, "Star" item 4947 and "Pebble" item 4890

item	Ø top/bottom in cm	height in cm	PU
8014.20PB	15/23	20	1 pc 

# VISION







For further information about the VISION series, philosophy and a far-reaching analysis of sommelier Silvio Nitzsche, please visit [www.zieher.com/en/highlights/vision](http://www.zieher.com/en/highlights/vision)



skillfully handblown



FRESH

**"You have never seen wine like this!"**

Silvio Nitzsche, WEIN | KULTUR | BAR Dresden



## The life and work of Silvio Nitzsche

"Of course, there is life without wine, but who wants that?"

During a career as a sommelier, which has spanned more than twenty years, Silvio Nitzsche has looked after both guests and wine in some of the best Michelin-starred restaurants. Some of his high-profile positions have been:

- Sommelier at "Dieter Müller Restaurant" (19.5 GM, \*\*\* Michelin), Bergisch Gladbach / GER
- Sommelier at "Erna's Elderberry House", Oakhurst / CA, USA
- Assistant Restaurant Manager and Sommelier at "Speisemeisterei" Restaurant (18 GM, \*\* Michelin), Stuttgart / GER

Silvio Nitzsche has now found a new home in the city of Dresden, where he has worked as a sommelier for over ten years at WEIN | KULTUR | BAR, which he opened there. He and his team have managed to establish a wine bar that many wine enthusiasts consider to be one of the best in Europe. He has succeeded in creating a place where wine is a permanent feature.

In 2018 Silvio Nitzsche has been voted one of the ten best sommeliers in Germany by the magazine "Der Feinschmecker".

[www.weinkulturbar.de](http://www.weinkulturbar.de)



## Filigree craftsmanship meets innovative design

"Zieher glasses are all about top quality craftsmanship, which is created in one of the most innovative and best glass-blowing workshops in the world. Each glass is unique and has been created from lead-free crystalline glass, using a traditional glass-blowing method.

As well as having a perfect, highly sophisticated and fascinating design, the glasses in the VISION range are guaranteed to provide maximum aroma and optimum development of the wine. However, it is particularly the fascination of the light, the colours and the visual depth, that makes it impossible to tear your eyes away from the glass, because: You have never seen wine like this!"

## The vision of simplicity

"No distinction is made between red wine or white wine glasses in this collection - the glasses are simply theme-based or character-based. The names of the glasses clearly explain what they are used for: You intuitively reach for the glass, which in the best way presents the flavours of the wine you particularly wish to emphasize. If you want a powerful wine to be more harmonious or a touch more lively and fresh, you pick the glass with the designation, that mirrors your requirement best."

Silvio Nitzsche



# The Zieher Food - VISION

The VISION series is predestined for wine and has been created to perfectly represent its different facets. In addition to this, the glasses offer an extraordinary platform for small delicacies or complimentary dishes from the chef. The harmonic wavy shape of the bottom creates an eye-catching ring when filled with spume or liquids. The depression in its centre provides space for amuse bouches or decorative highlights.



For distributors: Sample case VISION item 5661.01.  
We will be happy to inform you!

Get to know VISION! The glasses FRESH, STRAIGHT, INTENSE and BALANCED are also available in a single package.



## FRESH

crystalline glass, transparent, handblown

item	Ø / height in cm	content in ml	PU
5480.01	8 / 24	approx. 340	2 pcs
5480.01-1	8 / 24	approx. 340	1 pc

For extremely fresh white wines, Prosecco or any variety of sparkling wine, light rosé wines

The wide opening of this glass allows the carbon dioxide in sparkling wines to gently evaporate. This prevents the aroma perception of the nose from being broadsided by a concentration of carbon dioxide, which is often the case with classic sparkling wine glasses. The glass provides the palate with a centralised aroma concentration, which allows the wine to express its exquisitely lively, refreshing and light character. The development of the flavour-carrying, freshly acidic structures is encouraged, and individual features of the bouquet are brought into focus.



## STRAIGHT

crystalline glass, transparent, handblown

item	Ø / height in cm	content in ml	PU
5480.02	9 / 27	approx. 540	2 pcs
5480.02-1	9 / 27	approx. 540	1 pc

For pure grape varieties and fruity / aromatic red and white wines

The characteristics of the wine are reflected harmoniously one-to-one in this glass. The authenticity of the aroma culture of a grape variety is made discernible and presented in an unpretentious way, which makes this glass particularly suitable for all types of authentic grape varieties such as Riesling or Sauvignon Blanc. Light, aromatic red wines are transformed into pure drinking enjoyment.



## INTENSE

crystalline glass, transparent, handblown

item	Ø / height in cm	content in ml	PU
5480.03	10.5 / 28	approx. 640	2 pcs
5480.03-1	10.5 / 28	approx. 640	1 pc

For opulent, great growth, powerful white and red wines, rustic, acidic white and red wines, young and middle aged Bordeaux wines

The tapering neck of this glass intensifies the aroma molecules, which are positively hurled out of the glass. The acidity is harmoniously structured in the fruit bouquet and completes the opulent overall sensation of strength. The glass provides intensive oxidation, making it ideal for any wine that can be decanted or served in carafes.

# VISION



NEW

## SIDE

crystalline glass, transparent, handblown

item	Ø / height in cm	content in ml	PU
5480.07	9 / 10.5	approx. 480	2 pcs
5480.07-6	9 / 10.5	approx. 480	6 pcs

### For carbonated mineral water and soft drinks

Complementing the wine glass series, this glass is the tasteful companion for a stylish presentation of carbonated mineral water and soft drinks. The carbon dioxide is harmonised and the acids and mineral elements of fine sources are delivered to the tongue and the palate in a refreshing way, without being intrusive.



## BALANCED

crystalline glass, transparent, handblown

item	Ø / height in cm	content in ml	PU
5480.04	12 / 25	approx. 850	2 pcs
5480.04-1	12 / 25	approx. 850	1 pc

For white and red Burgundy, great Piedmontese wines, highly complex but sensitive white and red wines, extremely opulent rosé wines and old vintage champagne

A perfect glass for wine that is not for decanting due to its sensitive structure, but still requires a great deal of air. This crystal emanates pure consonance. Even with discordant wines, it succeeds in creating a concentrated and highly elegant impression. This glass turns wine into a complete aromatic experience, without overdoing it.

## RICH

crystalline glass, transparent, handblown

item	Ø / height in cm	content in ml	PU
5480.05	7 / 23	approx. 280	2 pcs

For fortified, sweet and dessert wines and any type of distilled beverages

A glass for the majority of heavyweight or high-proof drinks. The small presentation surface ensures that the wine or brandy does not become overly concentrated, so that the heavyweight aromatic elements are released in a nuanced way. Due to the glass having a narrow opening, the nose cannot go in very far, which prevents the perceiving mucous membranes from receiving a barrage of alcohol.

## NOSTALGIC

crystalline glass, transparent, handblown

item	Ø / height in cm	content in ml	PU
5480.06	10.5 / 16.5	approx. 250	2 pcs

For cocktails or as a food glass

The wide chalice is perfect for elegant presentations of creative cocktails, spectacular hors d'oeuvres or sophisticated sweets. Ideal in combination with SIDE for plain water, for easy service distinguishing both types of water.





For series VISION, we recommend the CAMBRO - Camrack® Warewashing System

The Camrack® Warewashing System will protect your valuable stemware and tumblers not only during washing, but also during stacking, storage and transportation. This helps to avoid costs related to damaged glasses. Detailed information about the Camrack® Warewashing System is available at [www.cambro.com](http://www.cambro.com).

#### Camrack® 4-in-1 Warewashing System

- Efficient washing
- Optimum sanitary storage
- Inventory control
- Safe, sanitary transportation

#### Camrack® Warewashing System

Cambro® offers a 4-in-1 system where glassware is washed, stored, identified and transported in one single unit. This multipurpose unit involves the Camdolly®, Camrack® compartment racks and the Camrack® cover.



item racks	number of compartments	max. height	max. Ø	rack height	for item	name
25S958	25	25.8 cm	8.7 cm	30.8 cm	5480.01	FRESH
20S1114	20	30 cm	9.8 cm	34.9 cm	5480.02	STRAIGHT
16S1114	16	30 cm	10.9 cm	34.9 cm	5480.03	INTENSE
9S958	9	25.8 cm	14.8 cm	30.8 cm	5480.04	BALANCED
30S958	30	25.8 cm	7.9 cm	30.8 cm	5840.05	RICH
16S638	16	17.4 cm	10.9 cm	22.5cm	5480.06	NOSTALGIC

#### Accessories - Dolly and Cover



#### Camdolly®

item	l x w x h in cm	colour
CDR2020	54.3x54.3x20.3	soft grey (151)

#### Camrack® Cover

item	l x w x h in cm	colour
DRC2020	50x50x2.4	grey (180)

## Feedbacks:



Laurens Mauquoi, Germany  
[www.der-weinsnob.de](http://www.der-weinsnob.de)

"Wine glasses from Zieher stand for absolute top quality. In my whole career as a wine blogger, I have never found glasses which accentuate the flavours like VISION does. My absolute recommendation!"



Sebastian Schaan, Germany  
[www.sommelier-blog.de](http://www.sommelier-blog.de)

"The waveform of the bottom and their shapes make the VISION series an excellent partner of the high-end gastronomy. Because of the respective glass, me as a sommelier can have enormous influence on development of the desired flavours."



Thomas Dötzer, Germany  
[www.doetzers.de](http://www.doetzers.de)

"From the very beginning, we have been excited by the appearance and the design of the glasses. But after the first degustation, we have been enthusiastic! We did not want to stop tasting. The wine simply gains a different character. The BALANCED glass makes decanting superfluous - and a Grappa out of the RICH glass is simply a great experience!"



Walid Romaya, USA  
[instagram.com/princeofwine](https://www.instagram.com/princeofwine)

"As a wine influencer, I have tasted thousands of wines in all glass shapes and sizes. The INTENSE wine glass is the perfect balance of beauty and functionality. It is a piece of art in your hand, that delivers and intensifies the wine aromas and characteristics through its unique and beautiful bulbous base. When using the glass for wine tastings in bars, people literally flooded me with comments about its beauty. Simply spectacular and one of the best wine glasses I have ever tasted with."



Emanuele Trono, Italy  
[Instagram.com/enoblogger](https://www.instagram.com/enoblogger)

"My experiences with the Zieher VISION series have been outstanding. The glasses praise the wine, they are extremely light, give expressiveness to the wine and are also a beautiful design object. They are a must-have for every wine lover and I also became Zieher-addicted."



Daniel Bayer, Germany  
[www.wein-verstehen.de](http://www.wein-verstehen.de)

"With their VISION series, Zieher managed to design innovative wine glasses, which lift wine tasting to a completely new level. I'm thrilled and can recommend explicitly their glass INTENSE for opulent wines. It stages particularly the German Riesling."



Günter Seeger, USA

"My whole team and I myself are convinced that the beautiful glasses of the VISION series establish a new league of wine glasses. We also receive a lot of positive feedback from our guests."



Rasmus Christensen, Denmark  
[instagram.com/winewherever](https://www.instagram.com/winewherever)

"The VISION series have a remarkable ability to bundle the fragrance, while providing an elegant and aesthetic appearance."

Follow us on social media and stay tuned!



[facebook.com/ZieherGermany](https://facebook.com/ZieherGermany)



[instagram.com/Zieher\\_Selection](https://instagram.com/Zieher_Selection)



[linkedin.com/company/zieher-kg](https://linkedin.com/company/zieher-kg)



[xing.com/companies/zieherkg](https://xing.com/companies/zieherkg)



# VAGANZA



The filigree champagne flute "Vaganza" is handblown and created in superior handicraft by experienced glassblowers. The result of this work is a crystal glass of highest craftsmanship. "Vaganza" captivates by its slim silhouette and elegant shape that bestows an exclusive character on the glass. The versions coated in gold or platinum fascinate with brilliant colours and the luxurious appearance of the applied decors. "Vaganza" seduces by its charming lightness and adds a touch of high society to any event.



### champagne flute "Vaganza"

crystalline glass, handblown, Ø 5 cm, 33.5 cm high, 210 ml content, in black gift box

item	colour	PU	
5481	clear	2 pcs	
5481.GPB	gold coloured	2 pcs	
5481.PPB	platin coloured	2 pcs	



# Miniatures



"Good taste is the art  
of understanding  
small things."

*Rousseau*



# "Cuspis"



A honey spoon of a different kind reliably holds the honey and, while being twirled, delivers it drip-free onto the fresh bread or into the tea. The tapering handle made of white borosilicate glass additionally offers the use as a skewer - for an extravagant presentation of dishes. A separately available tray made of black glass keeps the surface of tables clean and emphasizes the spoon by creating an appealing contrast.



The glass pillow "Donna" is available on page 150.



## glass spoon "Cuspis"

borosilicate glass, transparent, handblown, with star-shaped ball handle

item	l x w x h in cm	PU
4941.01	approx. 7x4x3.5	6 pcs



## honey spoon "Cuspis"

borosilicate glass, transparent/white, handmade, star-shaped, please note the safety instructions on each pack

item	length in cm	PU
4942.01	16	4 pcs



## small glass bowl/glass tray

glass, deep black, rectangular

item	l x w x h in cm	PU
5167	11.5x5.5x1.5	12 pcs





**glass cloche "Cuspis"**

borosilicate glass, transparent, handblown, star-shaped ball handle

item	for plate/bowl	Ø in cm	height in cm
4940.08	4389.09	8.5	12.5
4940.10	4389.11	10.5	14.5



The large cloche "Cuspis" and the suitable plateau plate are available on page 144.

**Borosilicate glass in its most beautiful shape!**

The primary design element of the series "Cuspis" is a glass ball studded with fine spikes. The cloches with a fitting porcelain plateau plate/mini bowl are available in three sizes and the inspiration for their shaping was derived from the nut of the oak tree. The star-shaped handle is located at the top of the cloches and allows for an uncomplicated handling of these classy covers. The unglazed outside of the porcelain bowls is reminiscent of acorn caps. The bowls can be used on both sides. When used as a plateau plate, the dishes move closer to the guest, while the filigree glass cloche protects the presented delicacies and puts them in the limelight at the same time. Used as a bowl, it offers space for gravies, sauces and more. Amuse-bouches and any kind of finger food can be served on the series' shapely amuse gueule spoons. In this case, the glass ball serves as a secure handle. The capacity of the spoons is sufficient for a usage with sauces or dips on the plate, but also at the breakfast buffet for jam and the like.



**plateau plate/small bowl "Cuspis"**

china, white, inside and useable area (plateau Ø approx. 6 cm/8 cm) glazed, outside biscuit, also useable as a bowl

item	Ø in cm	height in cm	content in l
4389.09	9	3	0.1
4389.11	11.5	3.5	0.18



**glass cloche with china saucer "Cuspis"**

set consists of:

**cloche** made of borosilicate glass, clear, handblown, with star-shaped ball handle

**saucer** made of white china, inside and useable area glazed, outside biscuit, useable on both sides, 1 set in black gift box

item	Ø in cm	height in cm	PU
4943.08PB	9	approx. 14	1 set (2 parts)
4943.10PB	11.5	approx. 17	1 set (2 parts)







### chopsticks

borosilicate glass, satined, handmade, please note the safety instructions on each pack (not suitable for children)

item	length in cm	PU
4885	21.5	1 set (2 parts)



### chopstick/knife rest "Flex"

borosilicate glass, transparent, handmade

item	l x w in cm	height in cm	PU
4886	8x2.3	approx. 2.3	2 pcs



### chopsticks with rest

set consists of:  
**chopsticks**, borosilicate glass, satined, handmade  
**rest**, borosilicate glass, transparent, handmade  
 2 sets in black gift box

item	l x w in cm	l (chopsticks) in cm	PU
4887.PB	8x 2.3	21.5	2 sets (6 parts)



### dip bowl/miniature "Flex"

borosilicate glass, transparent, handmade, with recess

item	l x w in cm	height in cm	PU
4889.16	16x7	approx. 2.8	4 pcs



### platter/miniature "Flex"

borosilicate glass, transparent, handmade, wavy

item	l x w in cm	height in cm	PU
4888.16	16x8	approx. 2	4 pcs
4888.22	22x11	approx. 2.5	4 pcs



## “Flex” - Perfectly designed and beautiful!

Tubes made of borosilicate glass – shaped into unique pieces by way of heat exposure. These perfectly designed elements of the “Flex” series can only be manufactured in such a sophisticated quality by extremely precise control of timing at exact temperatures.

Elegant presentation plates for amuse-bouches, fingerfood and other artfully arranged delights of upscale cuisine originate from this complex procedure. The “Flex” series is also suitable for intermediate courses or smaller desserts as well as presentations of bread and oil or dips.

The artfully curved inside of the tubes offers creative space for cutlery or napkins, decorative herbs, edible blossoms and more!

A rest for knives or chopsticks in the same language of design blends harmonically into this series. Chopsticks made of borosilicate glass are the perfect completion for this line. The satined surface of the sticks provides for pleasant haptics and creates an appealing contrast to the clear glass of the rest.





The black glass tray item 5141.34 is available on page 165.



## "Lacuna"



### small bowl

china, black, matt, square

item	l x w x h in cm	content in l	PU
3855.01	4.9x4.9x7	0.11	4 pcs



### glass straw

borosilicate glass, transparent, handblown, temperature resistant, please note the safety instructions on each pack of glass straws

item	Ø in cm	length in cm	PU
4980.16	0.8	16	24 pcs



### holder for test tubes

silicone, Ø 4.6 cm, 2.7 cm high, with grooves on the inside for easy insertion of glass tubes

item	colour	PU
4680.S	black	6 pcs
4680.W	white	6 pcs



### glass miniature

clear glass

item	Ø / height in cm	content in l	PU
5405	5 / 8.6	0.1	6 pcs



### miniature

china, stackable, Ø 5.3 cm, 7 cm high, 0.1 l content

item	colour	PU
4490	white	6 pcs
4490.01	black	6 pcs



# "Lacuna" - braving the gap!

Perforated walls, irregularly spread openings in filigree borosilicate glass – the small bowls of the series "Lacuna" stand out. Numerous holes in different sizes form the basis for sophisticated presentations of high-grade dishes. They set limits on the one hand, however offer various possibilities for creative arrangements and an extraordinary food presentation on the other.

The glass cone can be employed in three different ways. Rested horizontally and stabilized by a fork or a spoon, standing upright in various miniatures or put in elegant supports made of silicone or as an extraordinary cloche for the presentation of delicate tidbits.

Suitable accessories like anti-slip coasters made of food safe silicone or borosilicate glass straws enormously extend the scope of application of this series. Even working with small skewers for finger food may be envisaged.



*Design: Michael Schwarzmüller*



## cone "Lacuna"

borosilicate glass, transparent, handblown, with line of holes along the rim

item	Ø / height in cm	content in l	PU
4925.01	6 / 12	approx. 0.08	4 pcs



## small glass, bowl "Lacuna"

borosilicate glass, transparent, handblown, with line of holes along the rim

item	Ø / height in cm	content in l	PU
4926.01	12.5 / 6	approx. 0.08	4 pcs





# "Amuse"



4920 + 5145



## glass tin "Amuse"

borosilicate glass, transparent, handblown, with lid (black handle, height without lid: 7 cm), 6 feet of glass, in black gift box

item	Ø in cm	height in cm	content in l
4918.PB	6.5	11	approx. 0.14



## glass tin "Amuse"

borosilicate glass, transparent, handblown, with lid (black handle, height without lid: 9.5 cm), 6 feet of glass, in black gift box

item	Ø in cm	height in cm	content in l
4919.PB	8	13.5	approx. 0.28



## glass tin "Amuse"

borosilicate glass, transparent, handblown, smooth, with lid (black handle, height without lid: 6.5 cm)

item	Ø in cm	height in cm	content in l
4920	8	10	approx. 0.22

## glass tin "Amuse"

in black gift box

item	Ø in cm	height in cm	content in l
4920.PB	8	10	approx. 0.22



## glass tin "Amuse"

borosilicate glass, transparent, handblown, smooth, with lid (black handle, height without lid: 5.5 cm)

item	Ø in cm	height in cm	content in cm
4921	9	9	approx. 0.24

## glass tin "Amuse"

in black gift box

item	Ø in cm	height in cm	content in cm
4921.PB	9	9	approx. 0.24

The glass tray and many more inserts are available on pages 264 and 265.



**glass miniature "Amuse"**

borosilicate glass, transparent, handblown, double-walled

item	Ø / height in cm	content in l	PU
4914	8.5 / 7.8	approx. 0.19	6 pcs

**glass miniature "Amuse"**

in black gift box

item	Ø / height in cm	content in l	PU
4914.PB	8.5 / 7.8	approx. 0.19	1 pc 

Glass designer Michael Schwarzmüller puts delicious appetizers perfectly into focus. The filigree jars with their organic form offer top chefs and professional hosts the possibility of serving fingerfood and amuse-bouches in an "Amuse"-ing way.

"Amuse" wants to inspire imagination and stimulates playful experimentation. This series made of thin-walled, strong and heat-resistant borosilicate glass comprises of a variation of beautifully handcrafted cups, bowls, cloches and remarkable glass tins. The latter are perfectly suitable for the presentation of small soups and desserts, but may also be used as exceptional sugar bowls. The exact fitting lid ensures the protection and hygiene of the content. The double-walled bowls of the series in fact absorb heat or cold.

*Design: Michael Schwarzmüller*



**glass miniature "Amuse"**

borosilicate glass, transparent, handblown, double-walled

item	Ø / height in cm	content in l	PU
4915	11.5 / 6.5	approx. 0.25	6 pcs

**glass miniature "Amuse"**

in black gift box

item	Ø / height in cm	content in l	PU
4915.PB	11.5 / 6.5	approx. 0.25	1 pc 



Please note:  
Since all glasses of this series are handblown, deviations from the declared content may occur.





The plate of the series "SelectionA." is available on page 158, the charger plate made of glass on page 182.



### small glass creamer

borosilicate glass, transparent, handblown, handle curved and amber-coloured (approx. 7 cm long)

item	Ø / height in cm	content in l	PU
4995	6 / 5	approx. 0.1	4 pcs



### small glass creamer "Amuse"

borosilicate glass, transparent, handblown, single-walled, Ø opening on top approx. 3 cm

item	Ø / height in cm	content in l	PU
4922	8.5 / 8	approx. 0.25	6 pcs



### nut bowl "Amuse"

borosilicate glass, transparent, handblown, single-walled, Ø opening on top approx. 3.5 cm

item	height in cm	content in l	PU
4923	8.5 / 8	approx. 0.2	6 pcs

### nut bowl "Amuse"

in black gift box

item	Ø / height in cm	content in l	PU
4923.PB	8.5 / 8	approx. 0.2	1 pc 



### glass bowl

borosilicate glass, handblown, round

item	Ø / height in cm	content in l	PU
4965	11.5 / 7.3	approx. 0.6	6 pcs

Please note:

Since all glasses of this series are handblown, deviations from the declared content may occur.

# No sliding, no clattering - with the non-slip pads by Zieher!



The china series "DressCoat" is available on pages 148 and 149.



## coaster

silicone, Ø 5 cm, 3 mm thick, temperature resistant (-40 °C to +230 °C), food-safe, with rim on one side, for anti-slip placement of miniatures

item	colour	PU
4661.05S	black	24 pcs
4661.05W	white	24 pcs

The coasters made of food safe silicone are shapely accessories with a highly practical benefit. Clattering and wildly sliding miniatures on plates and trays are a thing of the past.

The skid-proof discs with their delicately structured, matt surface facilitate the service's work and ensure undisturbed enjoyment for the guest.

The coasters are available in two colours; the white ones can be integrated discreetly, whereas the black ones can be used deliberately as contrasting, decorative elements.



The glass bowls "Lacuna" are available on page 204 and 205.



4930 + 4681.S



## small glass bowl

borosilicate glass, handblown, round

item	Ø / height in cm	content in l	PU
4930	7/5	approx. 0.14	24 pcs



## ring "SelectionA."

silicone, Ø 8.3 cm, for the anti-slip placement of small glass bowl item 4930

item	colour	PU
4681.S	black	6 pcs
4681.W	white	6 pcs

These spherical bowls made of borosilicate glass accentuate in particular artfully presented dishes by their minimalistic and elegant design.

The flattened bottom of the bowls ensures a safe and even stand. Optionally available silicone rings for the small version guarantee skid-resistance and also allow a positioning at an angle.

All bowls are made of borosilicate glass, whose strength, temperature resistance, high transparency as well as absence of bubbles guarantee a high quality product experience.





# Double-walled thermo-glasses



Handblown, double-walled glasses made of borosilicate glass combine spectacular optics and extraordinary technical features. The vacuum between the two glasses prevents the formation of condensate on the outside of the glass when the ambient temperature is warm and the drinks are cold. The isolation effect keeps cold and warm liquids cold or warm for a longer time. Borosilicate glass by Zieher stands out due to its hardness and high temperature resistance.



## cocktail glass

borosilicate glass, transparent, handblown, double-walled

item	Ø / height in cm	content in l	PU
4962	10.5 / 16	approx. 0.2	6 pcs



## glass miniature

borosilicate glass, transparent, handblown, double-walled, with reinforced rim

item	Ø / height in cm	content in l	PU
4901.03	6 / 7.5	approx. 0.08	6 pcs



## glass tumbler

borosilicate glass, transparent, handblown, double-walled

item	Ø / height in cm	content in l	PU
4907	8 / 10	approx. 0.28	6 pcs



## glass straw

borosilicate glass, transparent, handblown, temperature resistant, please note the safety instructions on each pack of glass straws

item	Ø in cm	length in cm	PU
4980.12	0.8	12	24 pcs
4980.16	0.8	16	24 pcs



## glass miniature

borosilicate glass, transparent, handblown, double-walled

item	Ø / height in cm	content in l	PU
4903	5.5 / 8.5	approx. 0.1	6 pcs



## glass miniature

borosilicate glass, transparent, handblown, double-walled

item	Ø / height	content in l	PU
4901.01	6 / 5	approx. 0.08	6 pcs
4901.02	8.8 / 7.5	approx. 0.21	6 pcs



### small glass bowl "Halfmoon"

borosilicate glass, transparent, hand-blown, double-walled

item	Ø / height in cm	content in l	PU
4954.01	6 / 7.5	approx. 0.08	6 pcs
4954.02	8 / 9	approx. 0.17	6 pcs
4954.03	9 / 9.5	approx. 0.21	6 pcs

### small glass bowl "Halfmoon"

borosilicate glass, transparent, handblown, double-walled, in black gift box

item	Ø / height in cm	content in l	PU
4954.03PB	9 / 9.5	approx. 0.21	2 pcs 





### glass bowl

borosilicate glass, transparent, handblown, double-walled

item	Ø / height in cm	content in l	PU
4956.01	9 / 4	approx. 0.07	6 pcs
4956.02	11 / 5.5	approx. 0.15	6 pcs
4956.03	13 / 6.5	approx. 0.25	4 pcs
4956.04	15 / 7	approx. 0.3	4 pcs

### glass bowl

in black gift box

item	Ø / height in cm	content in l	PU
4956.02PB	11 / 5.5	approx. 0.15	1 pc 
4956.03PB	13 / 6.5	approx. 0.25	1 pc 
4956.04PB	15 / 7	approx. 0.3	1 pc 



### small glass bowl "Halfmoon"

borosilicate glass, inside with satin finish, handblown, double-walled

item	Ø / height in cm	content in l	PU
4964	12 / 7.5	approx. 0.35	6 pcs



### small glass bowl

borosilicate glass, inside with satin finish, handblown, double-walled

item	Ø / height in cm	content in l	PU
4963.01	6 / 8.5	approx. 0.05	6 pcs
4963.02	6.5 / 9.5	approx. 0.08	6 pcs



© Copyright 2012 by Fabian Sanger  
www.chocolate-culinary.com  
Book title: Sweet Inspirations





### glass miniaturer

clear glass, Ø 8 cm, 5 cm high, 0.13 l content

item	version	PU
5420	clear	6 pcs
5420.01	satinised	6 pcs



### glass miniaturer

clear glass, wavy rim, base: 0.07 l content, top part: 0.04 l content, for bridge "Modul" items 4584 and 4724

item	version	Ø / height in cm	PU
5423.01	base	6.5 / 5.5	12 pcs
5423.02	top	6.3 / 4.5	12 pcs

The creamer is handmade, deviations from the declared measurements may occur.



### small glass creamer

clear glass, handblown

item	Ø / height in cm	content in l	PU
5416	4.7 / 9.8	approx. 0.1	6 pcs



### glass miniaturer, 2 parts

glass, satinised, wavy rim

item	Ø / height in cm	content in l (bottom part)	PU
5445	5.5 / 7.5	approx. 0.05	6 pcs



### miniature glass bottle

clear glass, round, with glass lid (round), with notched stopper for pouring with closed lid, height incl. lid

item	Ø in cm	height in cm	content in l
5741	4.3	5.5	approx. 0.03



### test tube

borosilicate glass (temperature change resistant), with flanged rim and round bottom, for holder for test tube items 4680... and cork item 1501

item	Ø / height in cm	content in l	PU
4032.G	2 / 15	0.04	24 pcs

### cork

for test tube item 4032.G

item	Ø in cm	length in cm	PU
1501	2 / 1.7	2.6	24 pcs



The silicone holders for test tubes are also suitable as adjustable feet.



### holder for test tubes

silicone, Ø 4.6 cm, 2.7 cm high, with grooves on the inside for easy insertion of glass tubes, for test tube item 4032.G

item	colour	PU
4680.S	black	6 pcs
4680.W	white	6 pcs





### cork

plastic, ecru, for glass bottles items 5296.01 and 5296.02

item	Ø in cm	height in cm	PU
5297.01	2	2.2	24 pcs
5297.02	2.6	2.8	24 pcs



### glass bottle

clear glass, square, suitable cork item 5297.01 and 5297.02 (please order separately)

item	l x w x h in cm	content in l	PU
5296.01	3.9x3.9x8.5	0.04	12 pcs
5296.02	4.9x4.9x11	0.1	12 pcs

Its honed sides prevent the glass stopper from falling off when pouring from the closed bottle.



### glass bottle/creamer

clear glass, square, with glass stopper (round), with notched stopper for pouring with closed lid, height incl. stopper

item	l x w x h in cm	content in l	PU
5740	5x5x12.5	0.12	3 pcs



### small bowl

clear glass, square, delivery without lid item 5254.01 (please order separately)

item	l x w x h in cm	content in l	PU
5254	4.9x4.9x4.5	0.05	4 pcs



### small glass creamer

clear glass, square, delivery without lid item 5254.01 (please order separately)

item	l x w x h in cm	content in l	PU
5255	4.9x4.9x4.5	0.05	4 pcs



### glass miniature

clear glass, lid for small glass bowl item 5254 and glass creamer item 5255

item	l x w in cm	PU
5254.01	4.9x4.9	12 pcs

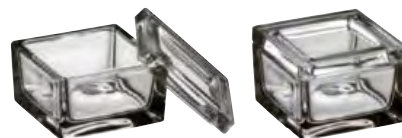

### small glass bowl

clear glass, square, delivery without lid item 5338.01 (please order separately)

item	l x w x h in cm	content in l	PU
5338	7x7x3.9	0.1	12 pcs

### glass miniature

clear glass, square, lid for small glass bowl item 5338

item	l x w in cm	PU
5338.01	7x7	12 pcs



### small butter & lard pot

clear glass, round

item	Ø in cm	height in cm	PU
5424	9	9.5	6 pcs



### glass bottle

clear glass, square, with swing top (plastic and stainless steel), height incl. swing top

item	l x w x h in cm	content in l	PU
5295.01	5.4x5.4x12.5	0.1	12 pcs
5295.02	6.7x6.7x14.5	0.2	12 pcs



### glass bottle

clear glass, with swing top (PVC lid), height incl. swing top

item	Ø / height in cm	content in l	PU
5290.01	4.5 / 14.5	0.1	12 pcs
5290.02	5.5 / 19	0.2	12 pcs



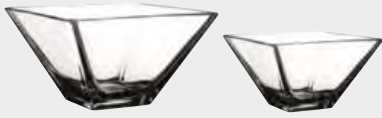

**glass bowl**

clear glass, square

item	l x w x h in cm	content in l	PU
5308.08	8x8x4.5	0.14	6 pcs
5308.11	11x11x6	0.3	6 pcs

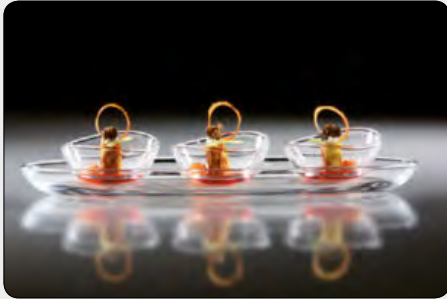

More sizes of the glass bowls are available on page 170.



**glass bowl**

clear glass, oval

item	Ø / height in cm	content in l	PU
5330.08	7.5 / 3.5	0.08	6 pcs

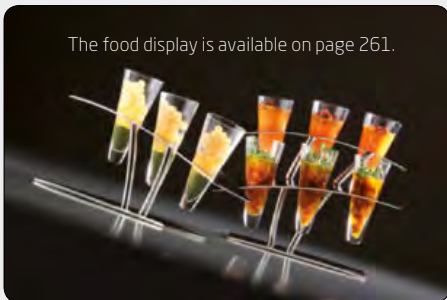

The food display is available on page 261.



**glass cone**

clear glass, for food display items 2194...

item	Ø / height in cm	content in l	PU
5415	3.5/8	0.03	12 pcs



The total "Unique" series are available on pages 146 and 147.

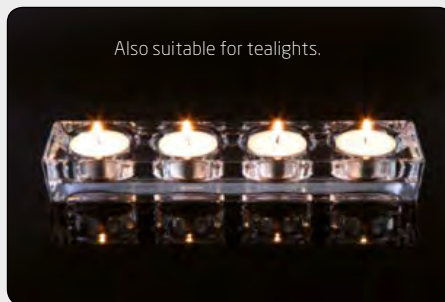

Also suitable for tealights.



**glass tray**

clear glass, 4 deepenings (Ø 4.6 cm), for inserts and portion jam up to Ø 4.4 cm (e. g. Darbo portion jam, 28 g and 40 g)

item	l x w x h in cm	PU
5428.04	23.5x6.2x3	6 pcs

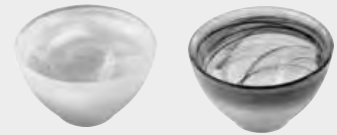

**glass bowl "Unique"**

glass, marbled, outside satined, round, Ø 10 cm, 6 cm high, content 0.2 L

item	colour	PU
5180.10	white	6 pcs
5181.10	black	6 pcs



**coaster/glass insert**

hardened clear glass, 4 mm thick, round, edges polished and deburred, with 4 transparent silicone feet

item	Ø in cm	PU
5244.11	11	6 pcs
5244	13	6 pcs



**glass bowl**

borosilicate glass, flat

item	Ø / height in cm	content in l	PU
4910	10.5 / 2.5	0.18	12 pcs



The melamine tray item 4590 is available on page 262.



**glass**  
clear glass

item	Ø / height in cm	content in l	PU
5380	7,5 / 10,5	0,32	6 pcs
5381	7,5 / 6	0,18	6 pcs

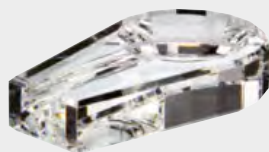

**ashtray for cigars**

optical glass, transparent, also usable as a rest for tongs or spoons, in black gift box

item	l x w x h in cm	PU
5210	15x9x3	6 pcs



**glass miniature**

clear glass, for bridges "Modul" items 4584 and 4724

item	Ø / height in cm	content in l	PU
5257	7 / 10	0,08	12 pcs



**glass miniature**

clear glass, for bridges "Modul" items 4584 and 4724

item	Ø / height in cm	content in l	PU
5405	5 / 8,6	0,1	6 pcs

5444 + 4593 (page 262)



**glass bowl**

clear glass, oval

item	l x w x h in cm	content in l	PU
5444	12,5x7x4	0,08	6 pcs

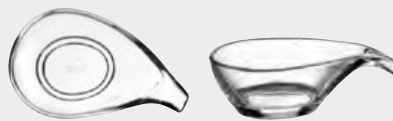

**glass bowl "Duo"**

clear glass

item	l x w x h in cm	content in l	PU
5441	11,5x7x3,5	0,07	6 pcs



**glass bowl**

borosilicate glass, handblown, round

item	Ø / height in cm	content in l	PU
4965	11,5 / 7,3	approx. 0,6	6 pcs



More sizes of the glass bowls are available on page 77.



**glass bowl**

dark grey, round, handblown, ground edge, for ring "SelectionA." items 4681...

item	Ø in cm	height in cm	content in l
4814.17	17	5,5	0,3



**glass bowl/cloche**

clear glass, handblown, for ring "SelectionA." item 4681...(please order separately)

item	Ø / height in cm	content in l	PU
5418	9/6	0,2	6 pcs

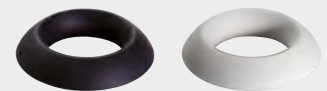

**ring "SelectionA."**

silicone, Ø 8,3 cm, for anti-slip placement of bowls item 5418, 4814.17 and 4930

item	colour	PU
a) 4681.S	black	6 pcs
b) 4681.W	white	6 pcs



**small glass bowl**

borosilicate glass, handblown, round

item	Ø / height in cm	content in l	PU
4930	7/5	approx. 0,14	24 pcs





**porcelain pillow "Donna"**

white

item	l x w x h in cm	PU
4461.03	12.3x8x2.7	12 pcs



**glass pillow "Donna"**

glass, satined, in black gift box

item	l x w x h in cm	
5446.01PB	16.5x11x3	



**plateau plate "DressCoat"**

china, white, useable area (plateau): Ø 6.5 cm, also useable as a bowl

item	Ø / height in cm	content in l	PU
4386.02	8 / 4	0.09	12 pcs



**plateau plate "DressCoat"**

china, white, useable area (plateau): Ø 7.5 cm, also useable as a bowl

item	Ø / height in cm	content in l	PU
4386.01	9 / 4.5	0.1	12 pcs



4081.12 + 4593  
(page 262)



**bowl**

china, white, oval

item	l x w x h in cm	content in l	PU
4081.12	12.5x7.5x4	0.1	12 pcs



**small bowl**

china, white, deep, oval

item	l x w x h in cm	content in l	PU
4326.11	11x9x3.8	0.1	12 pcs



**miniature plate**

china, white, flat, oval

item	l x w x h in cm	PU
4324.11	11x9x1.8	12 pcs



**small creamer**

china, white

item	l x w x h in cm	content in l	PU
4093	8.2x5.8x4.2	0.07	12 pcs

# "Cave"



## bowl "Cave"

biscuit china, white, inside glazed, opening: Ø approx. 8 cm, in black gift box

item	Ø in cm	height in cm	PU
4375.01PB	approx. 11	7	1 pc



Design: Wilma Greim

Like the shell hides the pearl, the porcelain bowl "Cave" conceals precious delicacies within its hard shell. At first sight, this porcelain piece only partly reveals its interior. "Cave" consists of intricately worked hard porcelain and captures by its soft shape and the velvety haptics of the unglazed outside. Touching the cave-shaped bowl, it feels almost like a palm stone made of white gold, having a soft appearance with delicious contents. "Cave" is predestined for a use at cocktail and hors d'oeuvres receptions or at the flying buffet. The miniature bowl can be carried comfortably and perfectly fits in the palm of the hand.



## cooling pack

nylon, black/white, non-toxic cooling gel

item	l x w in cm
5663.20	20x20



The glass bowls "Cave" are available on page 76.

## Stay cool!

Serving chilled food is primarily a technical challenge with certain dishes or intermediate courses. With Zieher's two-coloured cooling pads, this necessity can be met in a sophisticated way, also in terms of visual appearance. The wrapper made of black resp. white nylon fabric appears classy and unobtrusive. The pads are filled with gel which remains shapeable, even when frozen and thus allows an adjustment to the tableware used. The pads can also be used on the buffet. For further information, please have a look at pages 40 and 41.



The cruet stands made of stainless steel are available on page 252.



**creamer**

china, white, stackable

item	Ø / height in cm	content in l	PU
4489	5,3 / 9	0.13	6 pcs



**miniature**

china, stackable, Ø 5.3 cm, 7 cm high, 0.1 l content

item	colour	PU
4490	white	6 pcs
4490.01	black, matt	6 pcs

The vinegar/oil bottle is available on page 254, the cruet stand on page 255.



**small bowl "Catering"**

china, white

item	Ø / height in cm	content in l	PU
4499	8 / 5.5	0.2	6 pcs
4500	8 / 2.5	0.08	12 pcs



The cruet stand made of stainless steel is available on page 253.



**small bowl**

china, white

item	Ø / height in cm	content in l	PU
4498	8 / 6	0.17	6 pcs

Suitable etageres are available on pages 248 and 249.



**miniature plate**

china, round, flat, Ø 10.5 cm

item	colour	PU
4606.10	white, glossy	12 pcs
4607.10	black, matt	12 pcs



**plate**

china, round, flat, Ø 17 cm

item	colour	PU
4606.17	white, glossy	4 pcs
4607.17	black, matt	4 pcs

The glass bottles are available on page 260, the tray on page 257.



**small bowl**

china, square, 7 cm long, 7 cm wide, 4.5 cm high, 0.13 l content

item	colour	PU
3854	white	4 pcs
3854.01	black, matt	4 pcs



**small bowl**

china, white, square

item	l x w x h in cm	content in l	PU
3853	7x7x2	0.05	12 pcs



**small bowl**

china, white, square

item	l x w x h in cm	content in l	PU
3844	4x4x3	0.03	24 pcs



**small bowl**

china, square, 4.9 cm long, 4.9 cm wide, 7 cm high, 0.11 l content

item	colour	PU
3855	white	4 pcs
3855.01	black, matt	4 pcs



**small bowl**

china, square, 4.9 cm long, 4.9 cm wide, 4.5 cm high, 0.05 l content

item	colour	PU
3845	white	4 pcs
3845.01	black, matt	4 pcs



**small creamer**

china, white, square

item	l x w x h in cm	content in l	PU
3849	4.9x4.9x4.5	0.07	4 pcs

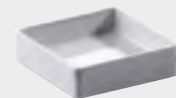

**small bowl**

china, white, square

item	l x w x h in cm	content in l	PU
3859	6.5x6.5x2	0.03	12 pcs



**small bowl**

china, white, rectangular

item	l x w x h in cm	content in l	PU
3858	13.5x6.5x2	0.07	12 pcs



**dip bowl "Twist" for olive oil**  
china, white, square

item	l x w x h in cm	PU
3912	12x12x1.8	6 pcs



**bowl "Modul"**

china, white, square, deep, for base trays "Modul" made of walnut and melamine

item	l x w in cm	content in l	PU
4381	11x11	0.07	12 pcs



**plate "Modul"**

china, white, square, flat, for base trays "Modul" made of walnut and melamine

item	l x w in cm	PU
4380	11x11	12 pcs



**bowl "Modul"**

china, white, rectangular, deep, for base trays "Modul" made of walnut and melamine

item	l x w in cm	content in l	PU
4384	22x11	0.22	12 pcs



**plate "Modul"**

china, white, rectangular, flat, for base trays "Modul" made of walnut and melamine

item	l x w in cm	PU
4383	22x11	12 pcs



Trays and miniatures made of melamine are available on page 122.

The whole "Modul" series is available on pages 131 to 139.





**NEW**

The black china plates are available on page 218, the etageres "Flex-Tree" on page 91.



**glass miniature plate**  
glass, 4 mm thick, green, structured, leaf shape

item	l x w in cm	PU
5037	14x7,5	12 pcs



**small glass bowl**  
glass, 4 mm thick, structured, dark grey, round, with slight corners

item	Ø in cm	height in cm	PU
5173	8	3	12 pcs



**small glass bowl/spoon rest**  
glass, 4 mm thick, structured, dark grey, organically shaped, slightly oval form

item	l x w in cm	PU
5172	11x7,5	12 pcs



The cloches are available on page 174.



**small glass bowl**  
clear glass, structured

item	l x w in cm	PU
5039	10x8,5	12 pcs



**small glass bowl**  
glass, deep black

item	l x w in cm	PU
5039.01	10x8,5	12 pcs



**small glass bowl**  
clear glass, structured, rectangular, flat

item	l x w x h in cm	PU
5099	11,5x5,5x1,5	12 pcs



**small glass bowl/glass tray**  
glass, deep black, rectangular

item	l x w x h in cm	PU
5167	11,5x5,5x1,5	12 pcs



**glass miniature plate**  
glass, deep black, flat

item	l x w in cm	PU
5034.01	10x10	12 pcs



**honey spoon "Cuspis"**  
borosilicate glass, transparent/white, handmade, star-shaped, please note the safety instructions on each pack

item	length in cm	PU
4942.01	16	4 pcs

# "Reef"- showpieces of table culture!

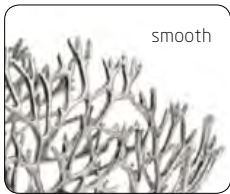

smooth



## small bowl/basket "Reef"

pewter, smooth outside, round, food-safe, not dishwasher-safe, with supporting feet, for small glass bowl item 4859.07, 4860.07 and 4930 (please order separately)

item	Ø in cm	height in cm	PU
2318	8	5	2 pcs



## glass bowl

glass, 2 layers, handmade, heavy quality, Ø 7 cm, 4.5 cm high, approx. 0.08 L content, for bowl/basket "Reef" item 2318

item	colour	PU
4859.07	white	6 pcs
4860.07	black	6 pcs



Large numbers of single parts are casted from premium pewter and subsequently assembled in high-grade craftsmanship to give shape to these items. The inimitable pieces of art created that way are unique items, which inspire by the polished surface of the organic structures and the rounded tails of the meshwork. The products of the "Reef" series are genuine gems of dining culture!

The small presentation baskets can be equipped with various miniatures made of clear or coloured glass and and give your food a stunning stage.



## small glass bowl

borosilicate glass, handblown, round for small bowl/basket "Reef" item 2318

item	Ø / height in cm	content in l	PU
4930	7/5	0.14	24 pcs



## bowl/basket "Reef"

pewter, smooth outside, round, food-safe, not dishwasher-safe, with supporting feet, for small glass bowl item 5166 (please order separately)

item	Ø in cm	height in cm
2310	13	8



## glass bowl

glass, 6 mm thick, dark grey, organically shaped, for bowl/basket "Reef" item 2310 (please order separately)

item	Ø / height in cm	content in l	PU
5166	13 / 6.5	approx. 0.3	2 pcs



More items of the „Reef“ series are available on page 64.





smooth



smooth



hammered



**etagere**

massive stainless steel 18/10, triangular, smooth finish, six times polished, not demountable

item	Ø in cm	height in cm
2187	13	16,5



**bread/pastry bowl**

massive stainless steel 18/10, hammered finish, six times polished

item	l x w x h in cm
2133.12	12x7,5x4,5



More sizes of the triangular bowls are available on page 85.



**bowl**

massive stainless steel 18/10, oval, smooth finish, six times polished

item	l x w x h in cm	content in l
2159.16	16x10x7	0,2
2159.20	20x12x9	0,35

More sizes of the triangular bowls are available on page 85.



**bowl**

massive stainless steel 18/10, triangular, hammered finish, six times polished

item	Ø in cm	height in cm	content in l
2180.09	9	4	0,08
2180.13	13	6	0,28



**bowl**

massive stainless steel 18/10, triangular, smooth finish, six times polished

item	Ø in cm	height in cm	content in l
2182.09	9	4	0,08
2182.13	13	6	0,28



The nut bowl is available on page 208.



**small bowl**

massive stainless steel 18/10, round, hammered finish, six times polished

item	Ø in cm	content in l
2153	7,5	0,11



**small bowl**

massive stainless steel 18/10, round, smooth finish, six times polished

item	Ø in cm	content in l
2153.01	7,5	0,11



**bowl "Artisan"**

stainless steel 18/10, inside polished, outside matt finish, round, hammered rim with golden adornment (brass)

item	Ø in cm	height in cm	content in l
2371.07	7,5	3,5	approx. 0,1
2371.11	11	5,5	approx. 0,3

Suitable etageres are available on page 89.



**amuse gueule stand with foot**

massive stainless steel 18/10, polished

item	l x w x h in cm
2204.08	11.5x9.5x8.5
2204.11	11.5x9.5x11.5



**ice cream cup with foot**

massive stainless steel 18/10, hammered, polished

item	l x w x h in cm	content in l
2207.11	11.5x10x11	0.15
2207.15	13.5x11x15	0.25





# Plateau plates



The placement of plateaus of the same height next to each other is only possible to a limited extent.



The coil shape holders and suitable inserts are available on page 92.



## miniature plate with rod

massive stainless steel 18/10, hammered, polished, plate approx. 9x8 cm, for marble platter 8052 and 8022.02

item	height in cm
2203.08	8
2203.13	13
2203.18	18
2203.23	23



## marble platter

black/brown, polished surface, sides rough-textured, stainless steel feet, 24 holes (Ø 5 mm), for holder coil shape items 2167..., skewer items 1939... or miniature plate items 2203... (please order separately)

item	l x w x h in cm
8052	45x31x5



Design: Itamar Horari



## marble platter

black/brown, polished surface, sides rough-textured, rectangular, with 3 holes (Ø 5 mm), with 4 feet of felt (not dishwasher-safe), for holder coil shape items 2167..., skewer items 1939... or miniature plate items 2203... (please order separately)

item	l x w x h in cm
8022.02	30x10x2.5



## bowl

granite, anthracite, fully polished

item	Ø in cm	height in cm	content in l
8034	18	7	0.7



and more!



### small skewer "Flame"

stainless steel 18/0, matt

item	length in cm	PU
1939.04	9.5	24 pcs

\*Drilled holes Ø 3 mm: suitable for small skewers items 1939.04 or usual skewers made of wood



**Slate** is a unique and exceptional natural product. The surfaces of our slate plates have the typical slaty cleavages, therefore every piece is unique. Small deviations in structure, thickness and weight of the plates cannot be avoided because of the nature of the product. There may be single inclusions of other minerals and fossils. These extraordinary features give slate its precious and vivid appearance. Please note: Specific groceries, especially those that contain fruit acid (citric acid), may damage the surface in case of longer contact. Therefore we recommend avoiding direct contact with edibles.

**Marble** is a natural product, which means that the dark brown marbling can vary strongly. This is exactly what creates the vivid and unique look of this natural stone. Please note: Specific groceries, especially those that contain fruit acid (citric acid), may damage the surface in case of longer contact. Therefore we recommend avoiding direct contact with edibles. Please clean only with a wet cloth and gentle cleaners. Not dishwasher-safe. Cleaning in a dishwasher may dull the surface.

**Granite** is a natural product. Deviations in colour or structure are possible. Infrequently, pockets in the stone may occur. Granite is the hardest and most impervious kind of our natural stones! Sushi trays made of granite are available on page 169.

### skewer plate, slate

natural slate, not sealed, rectangular, double, with 35 holes (Ø 3 mm\*), with 6 feet of felt (not dishwasher-safe)

item	l x w x h in cm
8051	35x25x2.6



### skewer

stainless steel 18/10, polished, 24 cm long

item	version	PU
1939.01	Moon	12 pcs
1939.02	Flame	12 pcs



8022.02 + 1939.01/1939.02





### tray

stainless steel 18/10, polished, for e.g. Darbo portion jam (28 g and 40 g), portion ketchup or mustard

item	version	l x w in cm
2191.03	3 holes (Ø 4.5 cm)	19.5x7.5
2191.04	4 holes (Ø 4.5 cm)	24x7.5

### miniature fork "Europa"

stainless steel 18/10, 2 mm thick, polished, excellent product quality, exceptional stability and durability

item	length in cm
0405.1388	16



The skewer plate made of slate is available on page 225.



### small skewer "Flame"

stainless steel 18/0, matt

item	length in cm	PU
1939.04	9.5	24 pcs

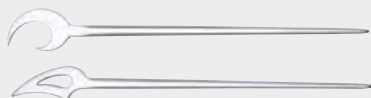

### skewer

stainless steel 18/10, polished, 24 cm long

item	version	PU
1939.01	Moon	12 pcs
1939.02	Flame	12 pcs



### amuse-gueule/tapas spoon "Modul"

china, white

item	l x w x h in cm	PU
4260.03	10x4x2,2	12 pcs



### amuse gueule/tapas spoon

china, white

item	l x w x h in cm	PU
4260.01	13x4x3	12 pcs

The glass platter is available on page 59.

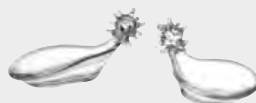

### glass spoon "Cuspis"

borosilicate glass, transparent, handblown, with star-shaped ball handle

item	l x w x h in cm	PU
4941.01	approx. 7x4x3.5	6 pcs



Suitable spoon rests made of walnut wood and melamine are available on pages 130 and 132.

hammered

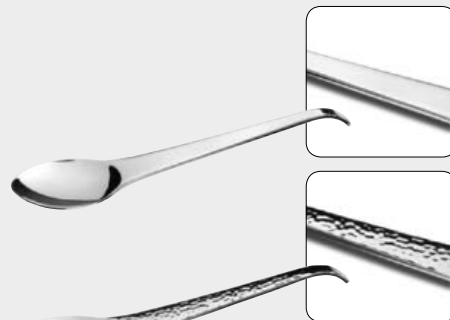
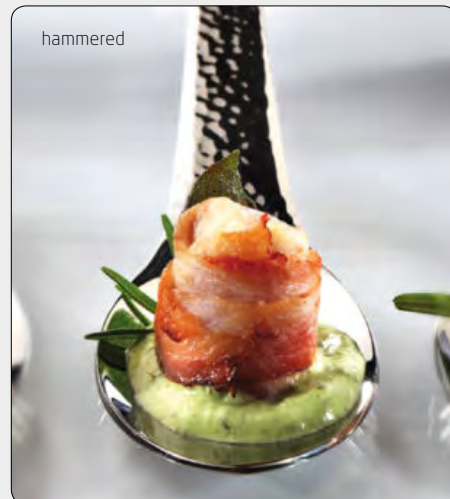

### party spoon

stainless steel 18/10, 4.3 mm thick, heavy quality, 21 cm long

item	version
1938	polished
1938.01	hammered



### honey spoon "Cuspis"

borosilicate glass, transparent/white, handmade, star-shaped, please note the safety instructions on each pack

item	length in cm	PU
4942.01	16	4 pcs

Cruet stands, trays,  
etageres and more!





# "Slope"



4595.45

Design: Wilma Greim

The melamine tray "Slope" is characterised by its unobtrusive shaping and the pleasant feel of the matt, finely structured surface. An elevated corner and the resultant asymmetry awards the tray that certain something.

Besides the obvious function as a service tray for espresso, cocktails, snacks and more, it also performs well in the hotel bathroom or as a decorative trivet in the hotel room.

"Slope" is available in two sizes. The robust raw material melamine appears very elegant due to its matt surface and of course, it complies with demands of everyday use like food safety, dishwasher resistance as well as stackability.



## tray "Slope"

melamine, black, matt, rectangular (oblique), stackable, utility space: approx. 26 cm x 15.5 cm

item	colour	l x w x h in cm	PU
4595.30	black	30x19.5x4.2	3 pcs

4595.30



## tray "Slope"

melamine, matt, rectangular (oblique), stackable, utility space: approx. 40 cm x 24 cm

item	colour	l x w x h in cm	PU
4595.45	black	45x29x4.2	2 pcs

# "Bento Box"

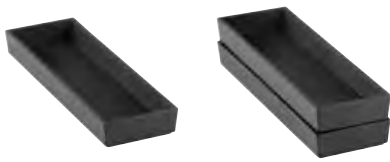

## insert/box

melamine, black, surface matt, stackable, food-safe, dishwasher-safe, not suitable for microwave and combi steam oven, up to 4 pieces fit into item 4578

item	l x w x h in cm	PU
4580	29.5x9x3.3	3 pcs

The lid of the Zieher bento box can also be used as a shapely tray.



The champagne flute "Vaganza" is available on page 198.

## "Bento Box" - flexible mobility

Serving guests at the pool, beach or on the terrace is often associated with longer walking distances for the service staff. The "Bento Box" from Zieher has been designed especially for these requirements – all components are stackable. This way they guarantee a space-saving storage and a comfortable, non-slip transport, even with several dishes at the same time.

Matt black melamine, modern design and subtle contrasts created by different surface structures, form the perfect setting for individual creations and popular classics such as burgers, club sandwiches or salads.

The versatility of the individual components also becomes evident in the cover, which has decorative ventilation slots to dissipate steam generated by hot food. This lid can also be used as a tray, whose less finely textured inside has an anti-slip effect.



## lid/tray

melamine, black, surface matt, stackable, food-safe, dishwasher-safe, not suitable for microwave and combi steam oven, with ventilation slots, suitable for item 4578, also usable as a tray

item	l x w x h in cm
4579	39.5x31.5x4



## Bento Box

melamine, black, surface matt, stackable, food-safe, dishwasher-safe, not suitable for microwave and combi steam oven, partition for cutlery/napkin/inserts (28 cm x 7.5 cm) or for platters (28 cm x 28 cm)

item	l x w x h in cm
4578	39x30.5x8.5



All information about the Bento Box are available on page 123.



"Connect!"

serving platters made of walnut!



Sublime in their appearance, unadorned in design, practical by compact formats and highly functional in combination - the solid wood boards of the series "Connect!" convince as a snack board, serving or cutting board, or as a presentation platter created by the combination of several elements.



**cutting/snack board "Connect!"**

walnut, oiled, not dishwasher-safe, pluggable, with handle, with 4 rubber feet, in black gift box

item	l x w x h in cm	length incl. handle
4774.31PB	26.5x20x2.3	31 



**cutting/snack board "Connect!"**

walnut, oiled, not dishwasher-safe, pluggable, with handle, with 4 rubber feet, in black gift box

item	l x w x h in cm	length incl. handle
4775.44PB	40x16x2.3	44.5 

"Connect!" is an extremely versatile tool for everyday use. The integrated tenon in the shape of a dovetail serves as a decorative handle with an artisanal touch. Suitable cutouts at the underside allow an easy combination of different elements. Skid-proof positioning feet ensure a firm stand, the slanted outer edges facilitate handling. The solid walnut wood is sealed with high-quality oils, which makes it easy to freshen up the surface from traces of everyday wear and tear.





**servicing tray "Solid"**

walnut, oiled, not dishwasher-safe, with changeable insert made of black coloured ceramic

item	l x w in cm
4780.46	46.5x23
4780.67	67.5x33

**Enjoyment in a pentagon**

These classy service platters take effect by their exceptional shape and the stylish combination of oiled walnut wood and slate grey ceramics.

Available in two different sizes for just one or more persons, single courses right up to mixed arrangements - so-called "sharing plates" - can be staged appealingly.

For bigger buffet set-ups, several plates can be arranged space-saving and thus provide an extraordinary structuring of the buffet spaces. The pentagonal design allows numerous arrangements - as a result, beautiful presentation areas for regional delicacies, desserts, antipasti and much more can be created.

The projecting handle permits an easy removal of the insert and thus allows an uncomplicated cleaning of the thin but very robust ceramic.



**insert/platter**

coloured ceramic, 6 mm thick, black, dishwasher-safe

item	l x w in cm
4780.46S	39x19.5
4780.67S	59x29

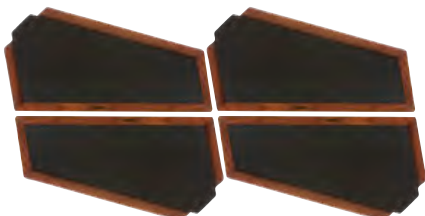
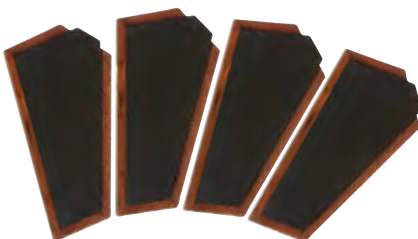



# "Solid"



This service tray with integrated separations is perfectly suitable for the service of small dishes at the pool, the beach or in the room. The major compartment has been designed for plates with a max. diameter of up to 29 cm, the lateral separation offers sufficient space for cutlery and napkin. Also insertion bowls with a max. width of 7.5 cm will find space and thus can be used for dips, salad and other side dishes. You will find a selection of suitable inserts on page 260. The trays are equipped with integrated grip holes and stackable. Finger joints at the corners, non-skid rubber feet and a food-safe sealing of the solid walnut wood fulfill the high-quality standards, which are valid for all items of the "Solid" range.



A suitable tray stand for the roomservice tray item 4735 is available on page 272.



## servicing tray "Solid"

walnut, food-safe sealed, not dishwasher-safe, stackable, 2 compartments: 30 cm x 30 cm and 30 cm x 8 cm (for cutlery or china/glass bowls), with 4 rubber feet

item	l x w x h in cm
4769	41.7x32.5x6.7



Rubber feet at the bottom which are slightly offset towards the middle enable the transport in a tray trolley in 1/1 EN-format 60 cm x 40 cm.



## room service tray "Solid"

walnut, food-safe sealed, not dishwasher-safe, stackable, recessed on one side of the rim, with 2 handles, with 4 rubber feet, suitable for tray stand "Solid" item 4748

item	l x w x h in cm
4735	60x40x5.4

# Breakfast in bed - Inroom dining!



The room service tray as well as the bed tray stand out due to the precious walnut wood, which is incorporated into these products with high-quality craftsmanship. The recessed longside enables comfortable dining directly off the tray. The retractable feet of the bed tray have been constructed in a very stable way and are securely kept in position by integrated magnets when folded in. The height of the erected tray has been chosen in a way that even with soft mattresses, a comfortable sitting beneath the tray is guaranteed. So start off the day with a boundlessly relaxing breakfast in bed!



### bed tray "Solid"

walnut, food-safe sealed, not dishwasher-safe, stackable, with feet, 2 handles, recessed on one side of the rim

item	l x w x h in cm (closed)	l x w x h in cm (set up)
4773	60x40x6.5	74x40x31

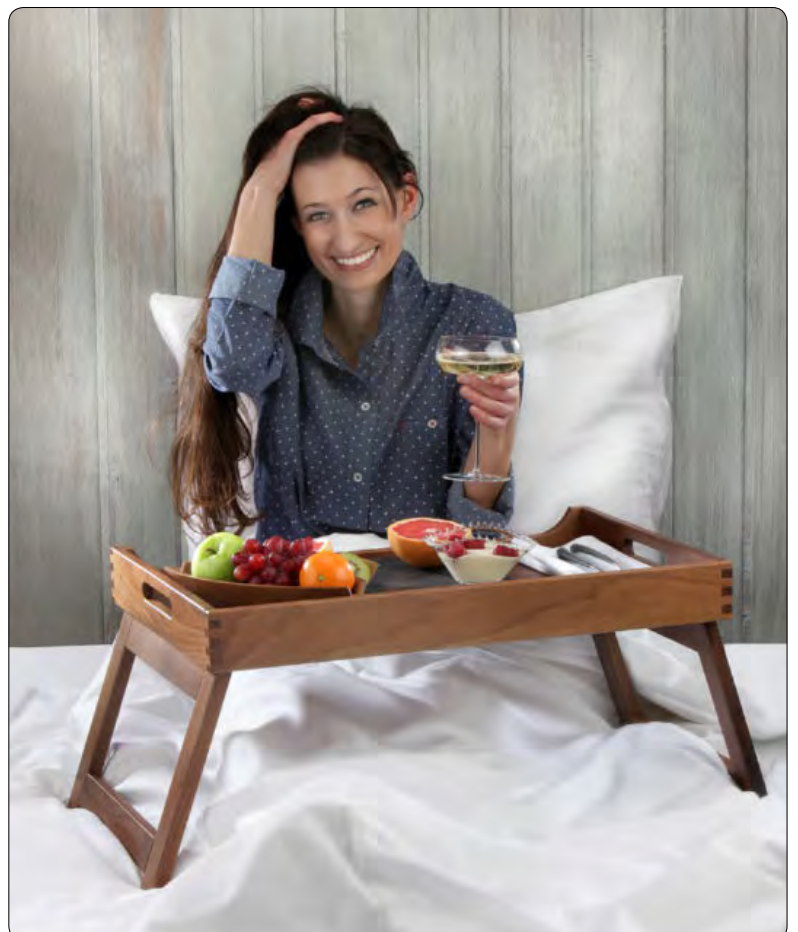



The boxes made of walnut and more items for the hotel room are available on pages 272 to 280.



### servicing tray "Solid"

walnut, food-safe sealed, not dishwasher-safe, with 4 rubber feet

item	l x w x h in cm	l x w in cm (inside)
4713	34x34x3	32x32



### servicing tray "Solid"

walnut, flat, food-safe sealed, not dishwasher-safe, with 2 recessed grips, with 4 rubber feet, in black gift box

item	l x w x h in cm	l x w (inside) in cm
4707.PB	53x37x4	50.2x34.2



### servicing tray "Solid"

walnut, deep, food-safe sealed, not dishwasher-safe, 2 recessed grips, with 4 rubber feet

item	l x w x h in cm	l x w (inside) in cm
4740	53x37x10	50.2x34.2



### glass platter

special hardened safety glass, 4 mm thick, rectangular, rounded edges, polished rim, dishwasher-safe, rubber feet included (adhesive), underside scratch-proof, for serving tray "Solid" items 4707.PB and 4740

item	version	l x w in cm
1668.03	black glass	50x34
1670.03	white glass	50x34

Suitable displays and various accessories for the service tray items 4740 and 4707.PB are available on pages 108 to 111.





# "Solid" - Wood in its most beautiful shape!

Wood from the European walnut tree, which is one of the most precious and most beautiful types of wood, forms the basis for this series. Both the wood's warm brown colours in different shades and its intensive and distinctive grain make every product a unique item. The high-quality workmanship in combination with the food-safe sealing guarantees long durability, even in daily use. Please note the enclosed care instructions, not dishwasher-safe, do not immerse in water!



The bread buffet "Solid" is available on pages 108 to 113.



## cutlery/napkin box "Solid"

walnut, food-safe sealed, not dishwasher-safe, with rubber feet in the lid (soft closure, can be opened to an angle of 90° only) and at the bottom, with black felt insert, stainless steel platter with space for an engraving (price and quantity upon request), height with open lid: 15.5 cm

item	l x w x h in cm	size inside in cm
4766	28.8x11.8x6	26x8.7



## cutlery box "Solid"

walnut, food-safe sealed, not dishwasher-safe, with acrylic glass lid, with 4 rubber feet, for cutlery with a length of up to 24.3 cm

item	l x w x h in cm
4720	26.5x16.2x8

Stackable in all commercial transport boxes in format 60 cm x 40 cm





"Solid"



1 + 2 + 3

1 + 2 + 5

## Delicacies in delicate setting!

Due to the comprehensive range of accessories, the "Solid" presentation box offers multiple application possibilities. The box, regularly fitted with a wooden sliding lid, can be equipped with several optionally available inserts made of top-quality solid surface material. The also available lid made of brown-tinted glass puts the presented goods in the limelight. Apart from an insert with round cavities for nine truffles/chocolates and a flat plate that can be used for layered chocolates, various little somethings or amuse bouches, there is also an insert available for commercial coffee capsules. The insert for cigars can hold up to four cigars and a separate compartment aside offers additional space for matches, cigar cutters, etc. No matter if it is an assortment of coffee specialities or various delicacies of the pâtisserie, the presentation box by Zieher provides the perfect setting for many purposes.



### 1 storage/presentation box "Solid"

walnut, food-safe sealed, not dishwasher-safe, with sliding lid made of wood, also useable with glass lid item 4762.18G (please order separately)

item	l x w x h in cm	size inside in cm
4762.18	18x18x6	approx. 16x16x4.2



### 2 glass lid

hardened glass, brown tinted, with recess, for storage/presentation box "Solid" item 4762.18

item	l x w in cm
4762.18G	17,3x16,7

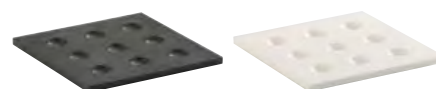

### 3 insert for chocolates

solid surface material, with 9 cavities (Ø 2.2 cm), for storage/presentation box "Solid" item 4762.18

item	colour	l x w x h in cm
4763.01S	black	15.8x15.8x1
4763.01W	white	15.8x15.8x1

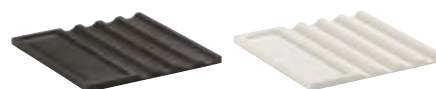

### 4 insert for cigars

solid surface material, for 4 cigars (grooves 1.9 cm wide), storage area for accessories (14.8 cm x 4.8 cm), for storage/presentation box "Solid" item 4762.18

item	colour	l x w x h in cm
4763.02S	black	15.8x15.8x1
4763.02W	white	15.8x15.8x1

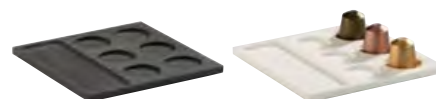

### 5 insert for coffee capsules

solid surface material, with 6 cavities (Ø 3.8 cm), storage area for accessories (14.8 cm x 4.8 cm), for storage/presentation box "Solid" item 4762.18

item	colour	l x w x h in cm
4763.03S	black	15.8x15.8x1
4763.03W	white	15.8x15.8x1

### 6 insert/platter

solid surface material, white, usable area: 14.8 cm x 14.8 cm, for storage/presentation box "Solid" item 4762.18

item	l x w x h in cm
4763.04W	15.8x15.8x1

1 + 2 + 4

1 + 2 + 5





## The most exquisite chocolates/truffles in an exclusive ambiance

“Solid”

Finest creations of the pâtisserie have to be presented in a worthy frame!

### Marco D’Andrea:

“In search of the perfect way to present my chocolates/truffles and after receiving manifold inspiration from colleagues, I have asked a carpenter of my acquaintances to manufacture some first prototypes. It was important to me that the box could be used to present jewellery and diamonds as well.

The round deepenings in the box are specifically matched, that even if the box is inclined, the truffles will not roll out. Chocolates/truffles with a diameter ranging from 22 to 28 mm fit easily into the deepenings. The dark wood of the walnut tree gives the box a fine and modern look. The brown tinted glass reveals the secrets hidden inside the box only once it is given a very close look. The glass can be inserted vertically into the back part of the box or can be slid in under the box. Once closed, anything inside the box can be stored hygienically. The narrow, sidelong compartment in each box can be used individually. Besides placing a tong or other serving cutlery, it can also be used for the presentation of more chocolates or petit fours.”

Idea and design for these presentation boxes “Solid” for truffles and filled chocolates are from Marco D’Andrea, pâtissier and “Junger Wilder 2012”. In 2014, D’Andrea has been proclaimed “Pâtissier of the year 2014” during the “Leaders of the Year Award” convention (powered by ROLLING PIN).

Further awards:

“Pâtissier of the year 2019” - Rolling Pin

“Pâtissier of the year 2020” - Gault Millau

“Pâtisserie team of the year 2020” - Schlemmer Atlas



Food & Design: Marco D’Andrea  
www.marcodandrea.de  
Instagram: marco.dandrea.pastry



### chocolate/truffle box “Solid”

walnut, food-safe sealed, not dishwasher-safe, with brown-tinted glass lid (can be used as rear wall or to slide in on the bottom side), square, 2 compartments: 1st compartment with 24 cavities for chocolates, 2nd compartment 21.3 cm x 6 cm

item	l x w x h in cm
4737	23.8x23.8x6

### chocolate/truffle box “Solid”

walnut, food-safe sealed, not dishwasher-safe, with brown-tinted glass lid (can be used as rear wall or to slide in on the bottom side), rectangular, 2 compartments: 1st compartment with 48 cavities for chocolates, 2nd compartment 21.3 cm x 6 cm

item	l x w x h in cm
4738	36.8x23.8x6



### chocolate/ice cube tongs

massive stainless steel 18/10, hammered finish, six times polished, 19 cm long

item	version
2138	stainless steel

Please note: the maximum filling height of the side compartment is 26 mm (when lid is closed).



# "Solid"



## box "Solid"

walnut, food-safe sealed, not dishwasher-safe, with 4 rubber feet, 2 compartments: 10.4 cm x 5.2 cm and 10.4 cm x 16.6 cm, for china/glass bowls 4.9 cm long and 4.9 cm wide

item	l x w x h in cm
4703	24.4x12.4x4



## box "Solid"

walnut, food-safe sealed, not dishwasher-safe, with 4 rubber feet, 2 compartments: 14.4 cm x 7.2 cm and 14.4 cm x 14.6 cm, for china/glass bowls 7 cm long and 7 cm wide

item	l x w x h in cm
4704	24.4x16.4x4



## box "Solid"

walnut, food-safe sealed, not dishwasher-safe, with 4 rubber feet

item	l x w x h in cm	l x w (inside) in cm
4705	24.4x16.4x4	22.4x14.4



## tray "Solid"

walnut, food-safe sealed, not dishwasher-safe, with 4 rubber feet, for china/glass bowls 4.9 cm long and 4.9 cm wide

item	l x w x h in cm
4719	15.2x15.2x2.5



## tray "Solid"

walnut wood, sealed food safe, not dishwasher-safe, for glass insert item 4708.G (please order separately)

item	l x w x h in cm	l x w (inside) in cm
4708	25.8x10.2x2	20.8x5.2



## glass insert/coaster

clear glass, with 4 transparent rubber feet, for tray "Solid" item 4708

item	l x w x h in cm	PU
4708.G	20.7x5.1x0.4	2 pcs



### card holder

walnut, varnished, slot 2 mm wide

item	l x w x h in cm	PU
4726	8x3x3	4 pcs



### bread basket "Solid"

walnut, food-safe sealed, not dishwasher-safe, boat-shaped

item	l x w x h in cm
4770.24	24.5x12x5



### bowl "Solid"

walnut, round, food-safe sealed, not dishwasher-safe, stackable, with corrugated pattern outside

item	Ø in cm	height in cm
4711.18	18	6
4711.24	24	8
4711.30	30	10

Suitable glass inserts are available on page 116.



4710 + 1669.33

### serving tray "Solid"

walnut, round, food-safe sealed, not dishwasher-safe, stackable, with corrugated pattern outside

item	Ø in cm	height in cm
4710	36	4



### bowl "Solid"

walnut, oblique, food-safe sealed, not dishwasher-safe

item	Ø in cm	height in cm
4760	13	10.5
4761	14	9

Design: Itamar Harari



The bread baskets made of solid walnut wood surprise with their exceptional design and their highly sophisticated handcraft. Designing these bowls, the Milanese designer Itamar Harari did not only think of serving bread, but also of the typical Italian Grissini. Recesses at both ends are especially suitable for those. A selection of fruit in the hotel room also receives much attention if stylishly presented in

these extraordinary bowls made of beautiful wood.









**glass cloche**

borosilicate glass, transparent, handblown, handmade, for coaster "Solid" items 4734...

item	Ø in cm	height in cm
4880.18	18.5	approx. 29-32
4880.22	22.5	approx. 35-38
4880.26	26	approx. 41-44
4880.30	30	approx. 48-51



**glass cloche**

clear glass, handblown, with round handle, for coaster "Solid" items 4734...

item	Ø in cm	height in cm
4850	18.5	31
4851	22.5	37
4852	26	43



Please note the advice concerning the cloches on page 177.



**cloche with wooden coaster and glass insert**

set consists of:

**cloche** made of borosilicate glass

**insert** made of hardened transparent glass (4 mm thick)

**saucer** made of walnut

1 set in black gift box

item	Ø in cm	height in cm	PU
4882.22PB	27	approx. 37-40	1 set (3 parts) 📦
4882.30PB	34.5	approx. 50-53	1 set (3 parts) 📦



**coaster "Solid"**

walnut, food-safe sealed, not dishwasher-safe, stackable, for glass cloche items 4850, 4851, 4852 and 4880... and glass inserts items 5244...

item	Ø / height in cm	for cloches / inlays
4734.01	23 / 3	Ø 18.5 / 16.7 cm
4734.02	27 / 3	Ø 22.5 / 20.7 cm
4734.03	30.5 / 3	Ø 26 / 24.2 cm
4734.04	34.5 / 3	Ø 30 / 28.2 cm



**coaster/glass insert**

hardened clear glass, 4 mm thick, round, edge polished and deburred, with 4 transparent silicone feet

item	Ø in cm	for coaster "Solid" item
5244.17	16.7	4734.01
5244.21	20.7	4734.02
5244.24	24.2	4734.03
5244.28	28.2	4734.04



NEW

# "Falcon"



The "Falcon" etagere - as most stainless steel items - can be refined by using the PVD process. Prices, minimum order quantities and delivery times upon request.



Anti-slip sleeves provide a safe positioning of buffet platters.

## etagere "Falcon"

massive stainless steel 18/10, highly polished, dishwasher-safe, food-safe, anti-slip silicone sleeves for use with buffet platters included

item	l x w x h in cm
8086	24x20x45



## coupe plate "Catering"

china, white, round, flat

item	Ø in cm	PU
3954.21	21	12 pcs

NEW



## coupe plate "Catering"

china, matt black, round, flat

item	Ø in cm	PU
3954.23S	23	12 pcs



## plate "Rough!"

china, matt black, round, structured surface

item	Ø in cm	PU
4567.24	24	4 pcs



## buffet platter, laminated plastic

laminated plastic, 8 mm thick, dark grey, black intermediate ply, break-proof, scratch-proof, dishwasher-safe, antistatic, deburred edges, rounded corners

item	version	l x w in cm
8006.08	rectangular	80x21
8006.14	rectangular	91x21
8006.15	rectangular	102x21

## “Falcon” - really detached!

This etagere, inspired by the elegance of a falcon, is giving wings to the creativity at the buffet and on the table. A single one can bear up to three plates on it's wings or when used as a duo, also fitting buffet platters or a combination of both can be installed. Anti-slip supports can be plugged on if needed and thus provide a safe positioning of the platters.

As a high-tea stand, the etagere carries plain white coup plates or matt-black plates with a slate-like structure, which fit exactly into the slots of the wings.

The mirror polished, solid stainless steel (3 mm) punctuates the precious impression of the dynamic shape, incorporated handrails facilitate the service. This majestic creature is sitting on a stylized branch, which also provides a firm stand.





# "Five o'Clock Tea"

The cloche item 4982.11 is available on page 175.



## etagere

massive stainless steel 18/10, triangular, smooth finish, six times polished, not demountable

item	Ø in cm	height in cm
2187	13	16.5



## etagere/pastry stand

massive stainless steel 18/10, smooth finish, six times polished, 4-armed (6 cm distance between the trays), not demountable

item	Ø trays in cm	height in cm
2189	2x14 / 2x18	25



The triangular bowls are available on page 85.

## etagere/pastry stand

in black gift box

item	Ø trays in cm	height in cm
2189.PB	2x14 / 2x18	25

# Etagere "DressCoat"



Anti-slip-rings



## etagere "DressCoat"

massive stainless steel 18/10, hammered, polished, 3-armed

item	Ø in cm	height in cm
2212.30	36	30

The etagere with three tiers, made of hammered and highly polished stainless steel, forms an extravagant basis for many sorts of plates and platters. A very special aesthetic set-up can be arranged by using a combination of several etageres along with the biggest plates of the "DressCoat" series (page 148).

In connection with the almost invisible tier stands the plateau plate appear amazingly airy and playful by their floating look-and-feel. A buffet presentation with an elegant vibrancy caused by the drapery of the "DressCoat" plates - that's where it comes into its own! Even in the hotel room the etageres can be positioned in an eye-catching way. Equipped with "DressCoat" or other tableware, small snacks, a selection of fruit or a sweet welcoming treat can be staged in an appealing way. All informations about this etagere are available on page 94.



## glass plate "Unique"

glass, white marbled, bottom satined, round

item	Ø in cm	PU
5178.21	21	6 pcs
5178.28	28	6 pcs



## glass plate "Unique"

glass, black marbled, bottom satined, round

item	Ø in cm	PU
5179.21	21	6 pcs
5179.28	28	6 pcs



You can find the plateau plate item 4388 and further items of the "DressCoat" series on page 148.



# "Flower Tower"



Design: Itamar Harari



## etagere with 3 tiers

massive stainless steel 18/10, hammered finish, polished, 21 miniature plates (approx. 9 cm x 8 cm)

item	Ø in cm	height in cm
2201	25	44.5

## etagere with 3 tiers

in black gift box

item	Ø in cm	height in cm
2201.PB	25	44.5



## etagere with 1 tier

massive stainless steel 18/10, hammered, polished, 7 miniature plates (approx. 9 cm x 8 cm)

item	Ø in cm	height in cm
2202	25	9

## etagere with 1 tier

in black gift box

item	Ø in cm	height in cm
2202.PB	25	9

## Floral shapes in a steely gloss!

Seemingly organic shapes in an interplay with the gloss and reflections of hammered and polished stainless steel make up the special charm of this product line. Two etageres as well as plateau plates in different heights (page 93) allow a visually harmonious yet flexible and diversified presentation of appetizers or desserts on the buffet. But also finger food, petit-fours, elaborately decorated cup cakes or a selection of pralines in the guest room find a convenient stage on these products.

The ice cream/sorbet cups and petit-fours stands in various sizes make a nice complement and individually stage appetizers or a dessert.

The formal base for all products is a slightly arched and kidney-shaped miniature plate. On three levels, the buffet etagere combines seven small plates each to a presentation platform of floral appearance and offers space to present up to 21 delicacies in a compact and stylish way. The single levels are supported by a filigree trestle made of massive stainless steel, which in shape and construction, deliberately readopts the design of other Zieher etageres. So nothing gets in the way of a harmonic combination of the different product lines.

The table etagere consists of one level only and is therefore perfectly suitable for the restaurant service to present intermediate courses, antipasti or dessert variations. This product is the ideal choice, even as a stylish storage dish for different types of fruit or accessories of daily use.



## amuse gueule stand with foot

massive stainless steel 18/10, polished

item	l x w x h in cm
2204.08	11.5x9.5x8.5
2204.11	11.5x9.5x11.5



## ice cream cup with foot

massive stainless steel 18/10, hammered, polished

item	l x w x h in cm	content in l
2207.11	11.5x10x11	0.15
2207.15	13.5x11x15	0.25

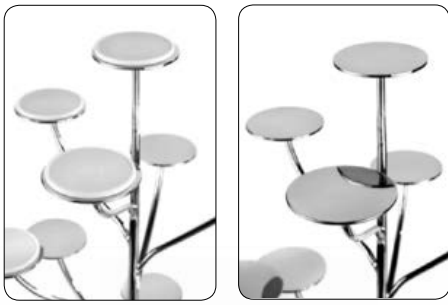

Anti-slip-pads:  
page 209.

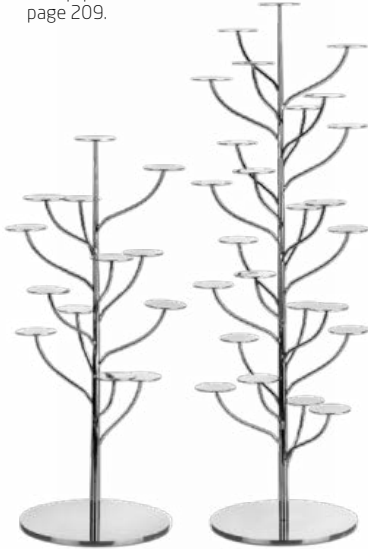

#### etagere "Flex-Tree"

massive stainless steel 18/10, smooth finish, polished,  
Ø 24 cm, with round discs (Ø 5.5 cm)

item	height	number of levels
2209.13	53	13
2209.25	72	25

## "Flex-Tree" & "Flower-Tree"

NEW

### A tree to dream of!

On 13 resp. 25 levels, these trees offer the possibility to present and showcase finger food, petit-fours and other delicacies.

The "Flex-Tree" enthuses by its versatility!! It can be equipped with various miniatures. You can find a small selection and all information on these etageres on pages 90 and 91.



The leaf shape of the "Flower-Tree" is based on the already existing plateau plates and "Flower-Tower" etageres (page 224 and 246). Especially on the buffet, this opens up the option to arrange installations diversified but yet harmonious and variable.

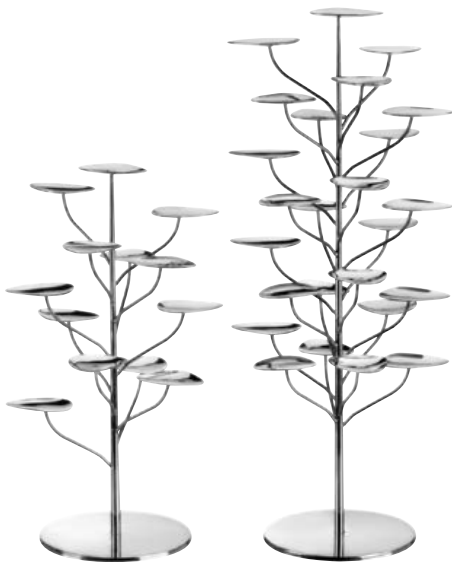

#### etagere "Flower-Tree"

massive stainless steel 18/10, smooth finish, polished,  
Ø29 cm, with miniature plates (ca. 9 cm x 7.5 cm)

item	height in cm	number of levels
2208.13	51.5	13
2208.25	71	25

#### etagere "Flower-Tree"

in black gift box

item	height in cm	number of levels
2208.13PB	51.5	13





# Etageres



## etagere

massive stainless steel 18/10, hammered finish, polished, with 3 or 4 insertion levels (Ø inside: 6.5 cm) for plates/bowls with max. Ø 11 cm

item	l x w x h in cm	levels
210703	12.5x11.5x23	3
210704	12.5x11.5x29	4



## 1 miniature plate

china, round, flat, Ø 10.5 cm

item	colour	PU
4606.10	white, glossy	12 pcs
4607.10	black, matt	12 pcs



## 2 miniature plate

china, white, flat, oval

item	l x w x h in cm	PU
4324.11	11x9x1.8	12 pcs



1

1

2



## Elegantly served and presented in style - classic plate etageres, newly inspired!

Shapely and individual stands by Zieher are suitable for numerous applications. The classic plate etageres are available with three, partly four levels and in two sizes. The classic mini format etageres effectively present petit fours, desserts, chocolates or other delicacies. The larger version is ideal for scones and jam during Five O'Clock Tea, but also a choice of cold cuts, cheese or fruit can be staged elaborately on the set table.



### etagere

massive stainless steel 18/10, hammered finish, polished, with 3 insertion levels (Ø inside: 10.8 cm) for plates/bowls with max. Ø 17.5 cm

item	l x w x h in cm	levels
2105.03	20.5x18x37.5	3



### 1 plate

china, round, flat, Ø 17 cm

item	colour	PU
4606.17	white, glossy	4 pcs
4607.17	black, matt	4 pcs



### 2 tray

massive stainless steel 18/10, square, hammered finish, six times polished, with feet

item	l x w x h in cm
2101.17	17.5x17.5x2.3



### 3 glass plate "Unique"

glass, marbeled, bottom satined, round

item	Ø in cm	colour	PU
5178.16	16.5	white	6 pcs
5179.16	16.5	black	6 pcs

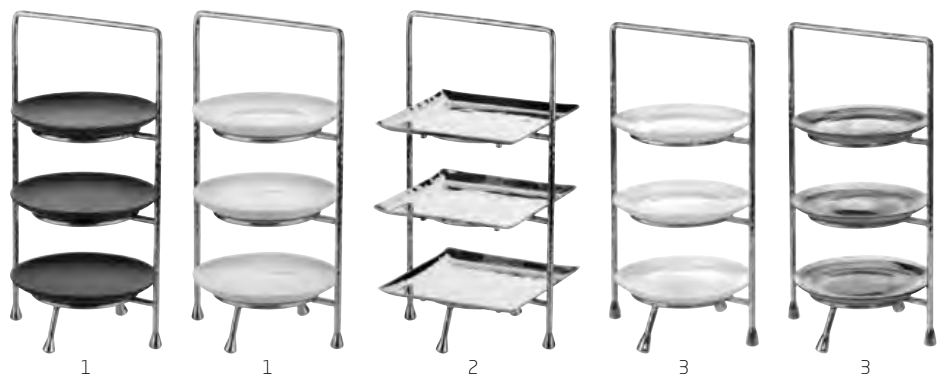





**etagere**

massive stainless steel 18/10, hammered finish, six times polished, including 3 removable trays item 2110.01 (30 cm long, 8 cm wide, 3 cm high)

item	l x w x h in cm (etagere only)
2110	11.5x11.5x39 (height without handle)



**tray**

massive stainless steel 18/10, rectangular, hammered finish, six times polished, with feet, for etagere item 2110

item	l x w x h in cm
2110.01	30x8x3



**toast rack**

massive stainless steel 18/10, hammered finish, six times polished, for 4 slices of toast

item	l x w x h in cm
2190	20x8.5x15



**pastry tray**

massive stainless steel 18/10, rectangular, hammered finish, six times polished

item	l x w in cm
2136	30x12.5



The jam tray item 2191.04 is available on page 251.

# Jam-Trays



Also suitable for tealights



## glass tray

clear glass, 4 deepenings (Ø 4.6 cm), for inserts and portion jam up to Ø 4.4 cm (e.g. Darbo portion jam, 28 g and 40 g)

item	l x w x h in cm	PU
5428.04	23.5x6.2x3	6 pcs



The etageres made of stainless steel are available on page 249.



## tray

stainless steel 18/10, polished, for e.g. Darbo portion jam (28 g and 40 g), portion ketchup or mustard

item	version	l x w in cm
2191.03	3 holes (Ø 4.5 cm)	19.5x7.5
2191.04	4 holes (Ø 4.5 cm)	24x7.5



## tray

stainless steel 18/10, satined, also suitable for Darbo portion jam, for inserts up to 4 cm x 4 cm

item	l x w x h in cm
2057	18.3x4.8x2

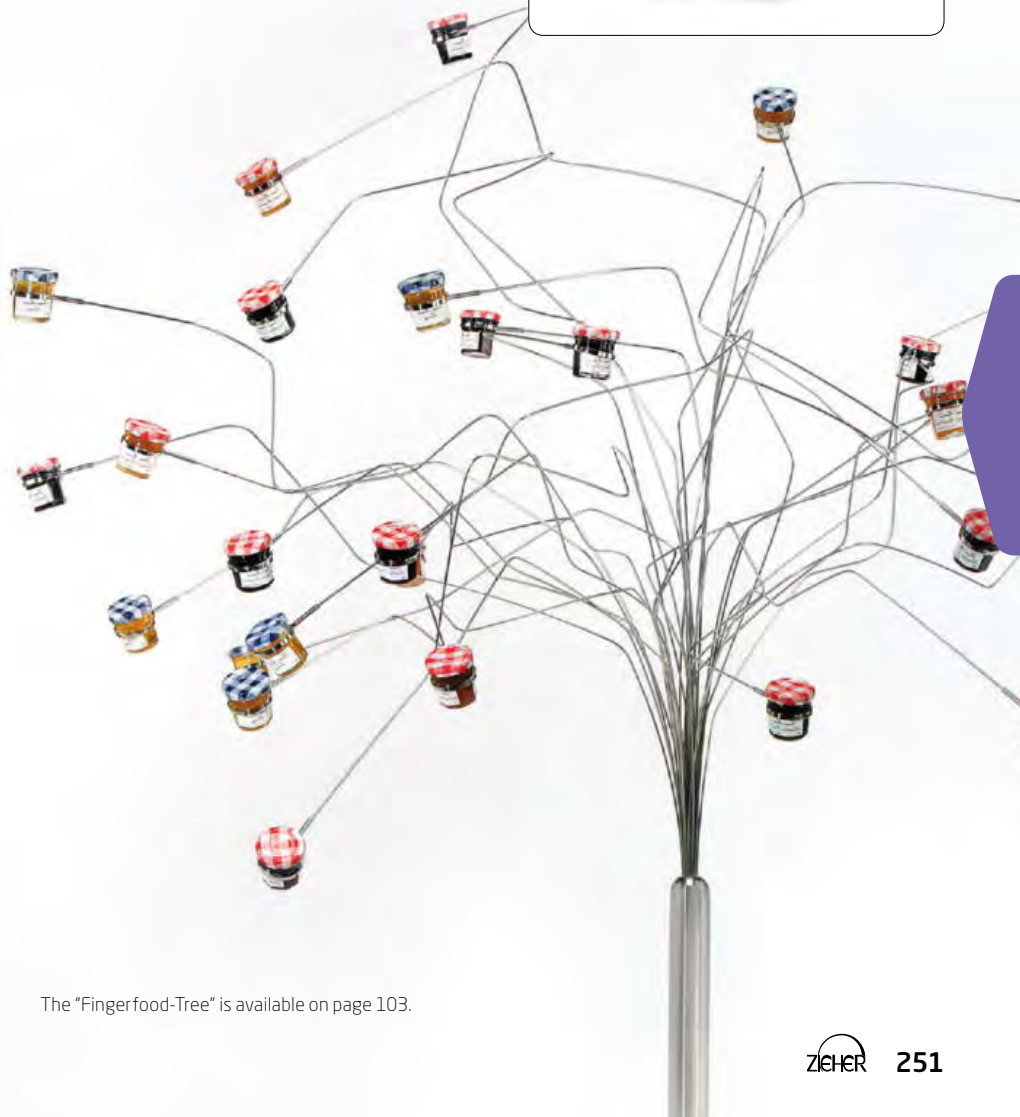

The "Fingerfood-Tree" is available on page 103.





### cruet stand

stainless steel 18/10, polished, heavy quality, for inserts with a maximum Ø of 5.3 cm

item	version	l x w x h in cm
3466.02	hammered	16x11.5x21



### glass miniature

borosilicate glass, transparent, handblown, double-walled, with reinforced rim

item	Ø / height in cm	content in l	PU
4901.03	6/7.5	approx. 0.08	6 pcs



### glass miniature

clear glass

item	Ø / height in cm	content in l	PU
5405	5 / 8.6	0.1	6 pcs



### creamer

china, white, stackable

item	Ø / height in cm	content in l	PU
4489	5.3 / 9	0.13	6 pcs



### miniature

china, stackable, Ø 5.3 cm, 7 cm high, 0.1 l content

item	colour	PU
4490	white	6 pcs
4490.01	black	6 pcs



3468.02 + 5317



**cruet stand**

stainless steel 18/10, polished, heavy quality, for inserts with a maximum Ø of 8.2 cm

item	version	l x w x h in cm
3468.02	hammered	18.5x8.7x22



**small glass bowl "Halfmoon"**

borosilicate glass, transparent, handblown, double-walled

item	Ø / height in cm	content in l	PU
4954.02	8 / 9	approx. 0.17	6 pcs



**small bowl "Catering"**

china, white

item	Ø / height in cm	content in l	PU
4499	8 / 5.5	0.2	6 pcs



**small bowl**

china, white

item	Ø / height in cm	content in l	PU
4498	8 / 6	0.17	6 pcs



**glass miniature**

clear glass

item	Ø / height in cm	content in l	PU
5420	8 / 5	0.13	6 pcs



**glass miniature**

clear glass, satined

item	Ø / height in cm	content in l	PU
5420.01	8 / 5	0.13	6 pcs



3468.02 + 4954.02



3468.02 + 5420 + 4954.02



3468.02 + 4498



3468.02 + 5317



**vinegar/oil bottle**

clear glass, with stainless steel nozzle, height incl. nozzle

item	Ø in cm	height in cm	content in l
5351	8	21	0.33

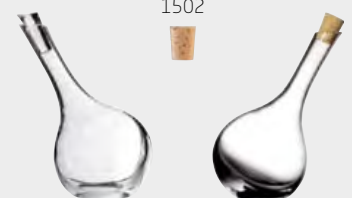

1502

**vinegar/oil bottle**

clear glass, with glass stopper

item	Ø / height in cm	content in l	PU
5317	8 / 15.5	0.23	2 pcs

**cork**

for vinegar/oil bottle item 5317

item	Ø in cm	length in cm	PU
1502	1.7/1.4	2.2	24 pcs



## Vinegar & oil



### vinegar/oil bottle

borosilicate glass, transparent, handblown and handmade, with 2 corks

item	content inside / outside in l	height in cm
4984	0.04 / 0.2	19



### vinegar/oil bottle

borosilicate glass, transparent, handblown and handmade, with 2 corks

item	content inside / outside in l	height in cm
4985	0.08 / 0.27	16.5



The cruet stand item 2058 is available on page 255.



### glass bottle/creamer

clear glass, square, with glass stopper (round), with notched stopper for pouring with closed lid, height incl. stopper

item	l x w x h in cm	content in l	PU
5740	5x5x12.5	0.12	3 pcs



### miniature glass bottle

clear glass, round, with glass lid (round), with notched stopper for pouring with closed lid, height incl. lid

item	Ø in cm	height in cm	content in l
5741	4.3	5.5	approx. 0.03



### "Ménage-à-trois"

stainless steel 18/10, for 3 bowls (Ø inside: 8.4 cm each)

item	Ø in cm	height in cm
2058	16.5	18

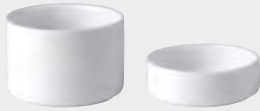

### small bowl "Catering"

china, white

item	Ø / height in cm	content in l	PU
4499	8 / 5.5	0.2	6 pcs
4500	8 / 2.5	0.08	12 pcs



### small bowl

china, white

item	Ø / height in cm	content in l	PU
4498	8 / 6	0.17	6 pcs



### glass tumbler

borosilicate glass, transparent, handblown, double-walled

item	Ø / height in cm	content in l	PU
4907	8 / 10	approx. 0.28	6 pcs



### glass miniature

clear glass

item	Ø / height in cm	content in l	PU
5420	8 / 5	0.13	6 pcs



### glass miniature

clear glass, satined

item	Ø / height in cm	content in l	PU
5420.01	8 / 5	0.13	6 pcs



### small glass bowl "Halfmoon"

borosilicate glass, transparent, handblown, double-walled

item	Ø / height in cm	content in l	PU
4954.02	8 / 9	approx. 0.17	6 pcs



"Ménage-à-trois"



The vinegar/oil bottles are available on pages 253 and 254.





# Cruet stands and trays ...



1+14+15

4+12+13



**1** cruet stand for inserts up to 4 cm x 4 cm  
stainless steel 18/10, satined, also suitable for Darbo-portion jam

item	l x w x h in cm
2056.02	9.4x9.4x13.6



**2** cruet stand for inserts up to 5 cm x 5 cm  
stainless steel 18/10, satined

item	l x w x h in cm
2056	11.4x11.4x16



3+28+29



**3** cruet stand for inserts up to 7 cm x 7 cm  
stainless steel 18/10, satined

item	l x w x h in cm
2056.01	15.4x15.4x22.5



**4** tray for inserts up to 4 cm x 4 cm  
stainless steel 18/10, satined, also suitable for Darbo portion jam

item	l x w x h in cm
2057	18.3x4.8x2

... made of stainless steel ...

Cruet stands and trays in many different sizes and variations as well as a number of suitable inserts are summarized on pages 256 to 260. The inserts and the compartments of the trays come in three different sizes (4 cm x 4 cm, 5 cm x 5 cm and 7 cm x 7 cm) and will therefore fit for every occasion.

Start making your own combinations!



6+28+29



**5** tray for inserts up to 5 cm x 5 cm  
stainless steel 18/10, hammered, polished,  
rectangular, heavy quality, with wide rim

item	l x w x h in cm	l x w in cm (inside)
3467.02	26.8x11.2x2	20.8x5.2



5+24

5+20+21



**6** tray for inserts up to 7 cm x 7 cm  
stainless steel 18/10, hammered, polished,  
rectangular, heavy quality, with wide rim

item	l x w x h in cm	l x w in cm (inside)
3469.02	37.5x15.5x2	29.5x7



6+26

6+29+30



... or bread boxes made of wood ...



**7** box "Solid" for inserts up to 5 cm x 5 cm  
walnut, food-safe sealed, not dishwasher-safe, with 4 rubber feet, 2 compartments: 10.4 cm x 5.2 cm und 10.4 cm x 16.6 cm

item	l x w x h in cm
4703	24.4x12.4x4



**8** tray "Solid" for inserts up to 5 cm x 5 cm  
walnut, food-safe sealed, not dishwasher-safe, with 4 rubber feet

item	l x w x h in cm
4719	15.2x15.2x2.5



**9** glass insert/coaster  
clear glass, with 4 transparent rubber feet, for tray "Solid" item 4708

item	l x w x h in cm	PU
4708.G	20.7x5.1x0.4	2 pcs



**10** tray "Solid" for inserts up to 5 cm x 5 cm  
walnut, food-safe sealed, not dishwasher-safe

item	l x w x h in cm	l x w (inside) in cm
4708	25.8x10.2x2	20.8x5.2



**11** box "Solid" for inserts up to 7 cm x 7 cm  
walnut, food-safe sealed, not dishwasher-safe, with 4 rubber feet, 2 compartments: 14.4 cm x 7.2 cm and 14.4 cm x 14.6 cm

item	l x w x h in cm
4704	24.4x16.4x4

... with suitable inserts made of glass and china ...

inserts up to 4 cm x 4 cm

inserts up to 5 cm x 5 cm

inserts up to 5 cm x 5 cm



**12 glass bottle**  
clear glass, square, suitable cork item 5297.01 (please order separately)

item	l x w x h in cm	content in l	PU
5296.01	3.9x3.9x8.5	0.04	12 pcs



**13 cork**  
plastic, ecru, for glass bottle item 5296.01

item	Ø in cm	height in cm	PU
5297.01	2	2.2	24 pcs



**14 small bowl**  
china, white, square

item	l x w x h in cm	content in l	PU
3844	4x4x3	0.03	24 pcs



**5 years guarantee**  
on the grinder

**15 salt & pepper mill set**  
acrylic glass, square, with ceramic grinder, without filling, 5-years guarantee

item	l x w x h in cm	PU
2779	3.7x3.7x9	1 set (2 parts)



**16 glass bottle**  
clear glass, square, suitable cork item 5297.02 (please order separately)

item	l x w x h in cm	content in l	PU
5296.02	4.9x4.9x11	0.1	12 pcs



**17 cork**  
plastic, ecru, for glass bottle item 5296.02

item	Ø in cm	height in cm	PU
5297.02	2.6	2.8	24 pcs



2+18+24



**18 glass bottle**  
clear glass, square, with swing top (plastic and stainless steel), height incl. swing top, **only for cruet stand item 2056!**

item	l x w x h in cm	content in l	PU
5295.01	5.4x5.4x12.5	0.1	12 pcs



**19 glass bottle/creamer**  
clear glass, square, with glass stopper (round), with notched stopper for pouring with closed lid, height incl. stopper

item	l x w x h in cm	content in l	PU
5740	5x5x12.5	0.12	3 pcs



10+16+17+20



**20 small bowl**  
clear glass, square, delivery without lid item 5254.01 (please order separately)

item	l x w x h in cm	content in l	PU
5254	4.9x4.9x4.5	0.05	4 pcs



**21 small glass creamer**  
clear glass, square, delivery without lid item 5254.01 (please order separately)

item	l x w x h in cm	content in l	PU
5255	4.9x4.9x4.5	0.05	4 pcs



**22 glass miniature**  
clear glass, lid for small glass bowl item 5254 and glass creamer item 5255

item	l x w in cm	PU
5254.01	4.9x4.9	12 pcs



**23 small bowl**  
china, square, 4.9 cm long, 4.9 cm wide, 7 cm high, 0.11 l content

item	colour	PU
3855	white	4 pcs
3855.01	black, matt	4 pcs



**24 small bowl**  
china, square, 4.9 cm long, 4.9 cm wide, 4.5 cm high, 0.05 l content

item	colour	PU
3845	white	4 pcs
3845.01	black, matt	4 pcs



**25 small creamer**  
china, white, square

item	l x w x h in cm	content in l	PU
3849	4.9x4.9x4.5	0.07	4 pcs



... for every purpose!

inserts up to 7 cm x 7 cm



4+14+15

3+29



**26 small glass bowl**  
clear glass, square, delivery without lid item  
5338.01 (please order separately)

item	l x w x h in cm	content in l	PU
5338	7x7x3.9	0.1	12 pcs



**27 glass miniature**  
clear glass, square, lid for small glass bowl item  
5338

item	l x w in cm	PU
5338.01	7x7	12 pcs



3+26+27+29

2+23+24



6+28+29



**28 glass bottle**  
clear glass, square, with swing top (plastic and  
stainless steel), height incl. swing top

item	l x w x h in cm	content in L	PU
5295.02	6.7x6.7x14.5	0.2	12 pcs



6+16+17+26



**29 small bowl**  
china, square, 7 cm long, 7 cm wide, 4.5 cm high,  
0.13 l content

item	colour	PU
3854	white	4 pcs
3854.01	black, matt	4 pcs



**30 small bowl**  
china, white, square

item	l x w x h in cm	content in l	PU
3853	7x7x2	0.05	12 pcs



**food display**

massive stainless steel 18/10, hammered finish, six times polished

item	version	l x w x h in cm
2194.03	3 holes (Ø 2.0 cm)	20x5.5x7.5
2194.06	6 holes (Ø 2.0 cm)	21x9.5x11.5

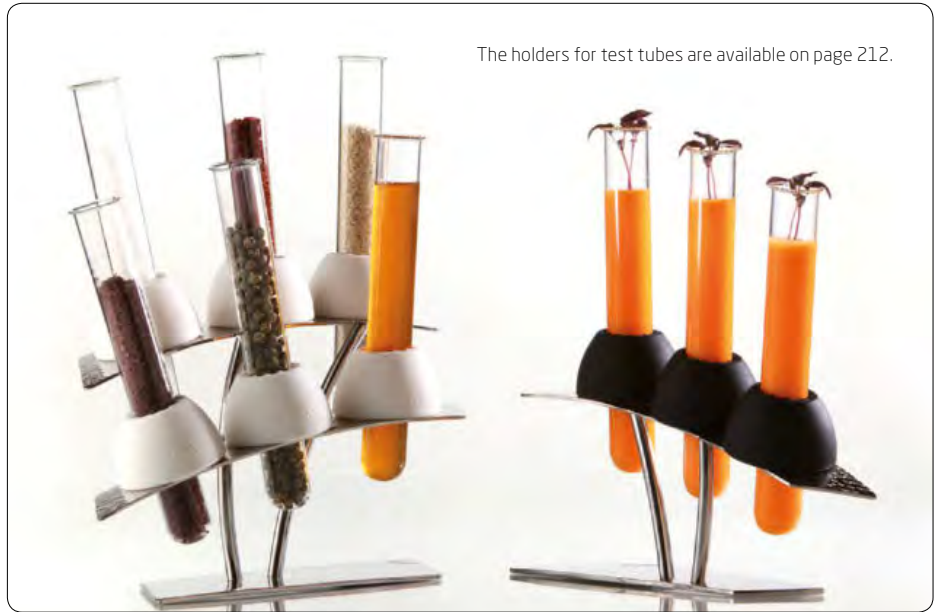

The holders for test tubes are available on page 212.



**glass cone**

clear glass, for food display items 2194...

item	Ø / height in cm	content in l	PU
5415	3,5/8	0,03	12 pcs





# Trays made of melamine ...

More items made of melamine and numerous variations are available on pages 122-128.



## tray

melamine, black, surface matt, food-safe, dishwasher-safe, not suitable for microwave and combi steam oven

item	l x w x h in cm	PU
4586	25.2x13.2x1.8	2 pcs

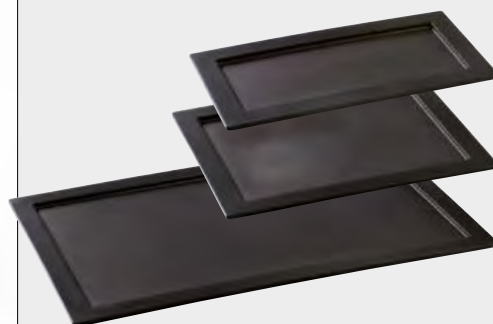

## GN tray

melamine, black, surface matt, food-safe, dishwasher-safe, not suitable for microwave and combi steam oven

item	l x w x h in cm	GN	PU
4587	32.5x17.6x1.8	1/3	2 pcs
4588	32.5x26.5x1.8	1/2	2 pcs
4589	53x32.5x1.8	1/1	2 pcs



## 2/8 GN tray

melamine, black, surface matt, food-safe, dishwasher-safe, not suitable for microwave and combi steam oven, with 3 oval sockets (diagonal), for small bowls items 4081.12 (china) and 5444 (glass)

item	l x w x h in cm	PU
4593	32.5x13.2x1.8	2 pcs

Suitable for items with a bottom diameter of less than 5.5 cm or 8.2 cm



## 2/8 GN tray

melamine, black, surface matt, food-safe, dishwasher-safe, not suitable for microwave and combi steam oven, with 3 round sockets (Ø 5.5 cm / 8.2 cm)

item	l x w x h in cm	PU
4590	32.5x13.2x1.8	2 pcs



## spoon rest "Modul"

melamine, black, surface matt, food-safe, dishwasher-safe, not suitable for microwave and combi steam oven, with 4 rubber feet (black)

item	l x w x h in cm	PU
4585	20x5x4	2 pcs

... with suitable inserts

The trays made of melamine in well-established GN-size can be equipped with many items.  
A wide range of different miniatures is available on pages 199 to 226.



Suitable inserts and boxes made of melamine are available on pages 124 to 128.



... for item 4590



**creamer**

china, white, stackable

item	Ø / height in cm	content in l	PU
4489	5.3 / 9	0.13	6 pcs



**miniature**

china, stackable, Ø 5.3 cm, 7 cm high, 0.1 l content

item	colour	PU
4490	white	6 pcs
4490.01	black, matt	6 pcs



**glass miniature**

borosilicate glass, transparent, handblown, double-walled

item	Ø / height in cm	content in l	PU
4903	5.5 / 8.5	approx. 0.1	6 pcs



**glass**

clear glass

item	Ø / height in cm	content in l	PU
5380	7.5 / 10.5	0.32	6 pcs
5381	7.5 / 6	0.18	6 pcs



**glass bottle**

clear glass, with swing top (PVC lid), height incl. swing top

item	Ø / height in cm	content in l	PU
5290.02	5.5 / 19	0.2	12 pcs



**small bowl "Catering"**

china, white

item	Ø / height in cm	content in l	PU
4499	8 / 5.5	0.2	6 pcs
4500	8 / 2.5	0.08	12 pcs



**small bowl**

china, white

item	Ø / height in cm	content in l	PU
4498	8 / 6	0.17	6 pcs



**glass miniature**

clear glass

item	Ø / height in cm	content in l	PU
5420	8 / 5	0.13	6 pcs



**glass miniature**

clear glass, satined

item	Ø / height in cm	content in l	PU
5420.01	8 / 5	0.13	6 pcs



**small glass bowl "Halfmoon"**

borosilicate glass, transparent, handblown, double-walled

item	Ø / height in cm	content in l	PU
4954.02	8 / 9	approx. 0.17	6 pcs



**glass tumbler**

borosilicate glass, transparent, handblown, double-walled

item	Ø / height in cm	content in l	PU
4907	8 / 10	approx. 0.28	6 pcs

... for item 4593



The melamine tray item 4593 is available on page 262.



**glass bowl**

clear glass, oval

item	l x w x h in cm	content in l	PU
5444	12.5x7x4	0.08	6 pcs



**bowl**

china, white, oval

item	l x w x h in cm	content in l	PU
4081.12	12.5x7.5x4	0.1	12 pcs



# Trays made of glass ...

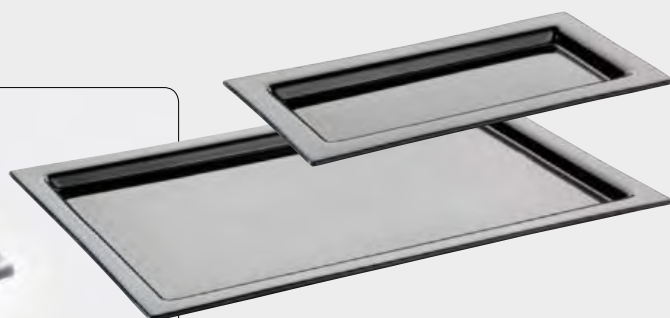

## glass tray

glass, deep black, rectangular, for buffet or flying buffet, also functions as a tray

item	l x w x h in cm
5141.34	34x18x2
5141.50	51x35x2



## glass tray

glass, deep black, square, for buffet or flying buffet, functions as a tray or as a charger plate

item	l x w x h in cm
5142.34	35x35x2

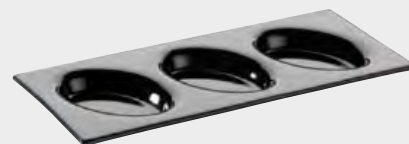

## glass tray

glass, deep black, with 3 oval sockets (diagonal, bottom area: 4.7 cm x 8.5 cm), for bowl items 4081.12 (china) and 5444 (glass)

item	l x w in cm
5143	32x14



The cocktail glass is available on page 210.

5145 + 4962

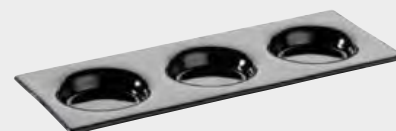

## glass tray

glass, deep black, with 3 round sockets (bottom area: Ø 6 cm)

item	l x w in cm
5145	32x12

... for item 5143



**bowl**

china, white, oval

item	l x w x h in cm	content in l	PU
4081.12	12.5x7.5x4	0.1	12 pcs



**glass bowl**

clear glass, oval

item	l x w x h in cm	content in l	PU
5444	12.5x7x4	0.08	6 pcs

... for item 5145



**small bowl**

china, white, deep, oval

item	l x w x h in cm	content in l	PU
4326.11	11x9x3.8	0.1	12 pcs



**glass bowl "Duo"**

clear glass

item	l x w x h in cm	content in l	PU
5441	11.5x7x3.5	0.07	6 pcs



**glass bowl**

borosilicate glass, transparent, handblown, double-walled

en- fehlt	Ø / height in cm	content in l	PU
4956.01	9 / 4	0.07	6er Pack



**cocktail glass**

borosilicate glass, transparent, handblown, double-walled

item	Ø / height in cm	content in l	PU
4962	10.5 / 16	approx. 0.2	6 pcs

More sizes are available on page 211.



**small glass bowl "Halfmoon"**

borosilicate glass, transparent, hand-blown, double-walled

item	Ø / height in cm	content in l	PU
4954.01	6 / 7.5	approx. 0.08	6 pcs



... with suitable inserts!



**glass**

clear glass

item	Ø / height in cm	content in l	PU
5380	7.5 / 10.5	0.32	6 pcs
5381	7.5 / 6	0.18	6 pcs



**glass tin "Amuse"**

borosilicate glass, transparent, handblown, smooth, with lid (black handle, height without lid: 6.5 cm)

item	Ø in cm	height in cm	content in l
4920	8	10	approx. 0.22



**nut bowl "Amuse"**

borosilicate glass, transparent, handblown, single-walled, Ø opening on top approx. 3.5 cm

item	height in cm	content in l	PU
4923	8.5 / 8	approx. 0.2	6 pcs



**small glass creamer "Amuse"**

borosilicate glass, transparent, handblown, single-walled, Ø opening on top approx. 3 cm

item	Ø / height in cm	content in l	PU
4922	8.5 / 8	approx. 0.25	6 pcs



# "Fakir"



## bowl/display "Fakir"

brass, inside golden (transparent coating, food-safe), outside dark patinated, not dishwasher-safe

item	Ø in cm	height in cm
2380.07	7,5	11
2380.12	12,5	10
2380.15	15	8,5
2380.18	18	9,5



## coaster/glass insert

hardened clear glass, 4 mm thick, edges polished and deburred, with 4 transparent rubber feet

item	Ø in cm	PU
5244.11	11	6pcs
5244	13	6pcs
5244.17	16,7	1 pc
5244.21	20,7	1 pc
5244.24	24,2	1 pc
5244.28	28,2	1 pc

Massive brass, produced in traditional sand casting, creates unique sculptural items, which enthuse especially by their contrast between matt golden surfaces and dark patination. An interesting add-on to the "Fakir" bowls are round glass platters of the Zieher product range. These can be laid on easily and thus generate the option to use the impressive objects on both sides.

Please note: The items made of brass are suitable for cold/dry food only. Not dishwasher-safe.



## ashtray for cigars

optical glass, transparent, also usable as a rest for tongs or spoons, in black gift box

item	l x w x h in cm
5210	15x9x3





# Candle holders Wind lights







For tealights or candles up to a height of 10 cm and a diameter of 7 cm.

## "Somnia"

At first glance the golden branches, strapped to a bundle, are reminiscent of a besom of a different kind. With candlelight, this extraordinary lighting object creates fascinating effects and provides for a cosy and comfortable ambience.

The filigree rods, visually appealing like thin branches, are made of brass and manufactured piece by piece in traditional sand casting. Afterwards, they are soldered onto a solid baseplate with an elevated rim. This baseplate avoids the leakage of wax and protects the table surface from the heat. Additionally, it forms the frame for a removable cylinder made of heat resistant glass, which by way of its satined surface, intensifies the mood of the light and protects the flame from wind at the same time.



### candle holder/wind light "Somnia"

brass, golden, matt, not dishwasher-safe, for glass insert item 4991.02 (please order separately) and candles up to Ø 7 cm

item	Ø stand in cm	Ø top in cm	height in cm
2383.01	11	approx. 16.5	approx. 19.5



### wind light

borosilicate glass, satined inside, open at the top and at the bottom, for candle holder/wind light "Somnia" item 2383.01

item	Ø in cm	height in cm	PU
4991.02	9	14.5	6 pcs



### candle holder/wind light "Somnia"

set consists of:

**candle holder/wind light "Somnia"** made of brass, golden, not dishwasher-safe, for candles up to Ø 7 cm  
**glass insert** made of borosilicate glass, satined inside, open at the top and the bottom,  
 1 set in black gift box

item	Ø foot / top in cm	height in cm	PU
2384.PB	11 / approx. 16.5	approx. 19.5	1 set (2 parts) 





For tealights or candles up to a height of 10 cm and a diameter of 7 cm.



**candle holder/wind light "Reef"**

pewter, surface smooth, food-safe, not dishwasher-safe, with feet, for glass insert item 4991.02 and candles up to Ø 7 cm

item	Ø in cm	height in cm
2315.01	10	15.5



**wind light**

borosilicate glass, satined inside, open at the top and at the bottom, for candle holder/wind light "Reef" item 2315.01

item	Ø in cm	height in cm	PU
4991.02	9	14.5	6 pcs



**candle holder/wind light "Reef"**

Set consists of:

**candle holder/wind light "Reef"** made of pewter, surface smooth, food-safe, not dishwasher-safe, with feet, for candles up to Ø 7 cm

**glass insert** made of borosilicate glass, satined inside, open at the top and at the bottom, 1 set in black gift box

item	Ø in cm	height in cm	PU
2316.PB	10	16.5	1 set (2 parts)



The wind light fascinates by reflections of the candlelight in the silvery metal and the dancing shadows of the slender structures. A removable cylinder made of heat resistant glass protects the flame from wind and thus allows the usage in the garden and on the terrace.



Since medieval times, pewter has been used primarily for table top items and has been the most important raw material for a very long time. The popularity of pewter first started decreasing in the 18th and 19th century by the progressing development of glass and the increasing popularisation of porcelain. Since then the usage of pewter has shifted mainly to decorative elements. Up-to-date pewter is 100 % lead-free and therefore uncritical when used for food.



# Wind lights



The stepped drillings in our wind lamps made of walnut allow the usage of Zieher LED tealights as well as standard tealights with a diameter of 38 mm and 58 mm.



## coaster "Solid"

walnut, food-safe sealed, not dishwasher-safe

item	Ø / height in cm	Ø inner circle in cm
4700.01	15.3 / 2	9.3



## tealight holder "Solid"

walnut, food-safe sealed, not dishwasher-safe, oblique, with stepped hole for small (Ø 4 cm) and large (Ø 6 cm) tealights and for glass wind light item 4991.02

item	Ø in cm	Ø inside in cm	height in cm
4716	13	9.4	10.5

Please note:  
The wind lights made of glass items 4987.01 can get very hot if wax candles are used for longer burning times. We recommend to use our LED tealights (item 8130).



## wind light/smoker cloche

borosilicate glass, transparent, with 3 notches at the bottom, open at the top, handmade

item	Ø in cm	height in cm
4987.01	9	approx. 12-13



## wind light

borosilicate glass, satined inside, open at the top and at the bottom, for tealight holder "Solid" item 4700.01 and 4716

item	Ø in cm	height in cm	PU
4991.02	9	14.5	6 pcs

## Consistently long lighting time with deceptively real flickering effect!

The LED-candles, in combination with different fitting Zieher tealight holders, turn every table into a homelike place for romantic hours. The power supplies, which are available separately, optionally with EU-, UK- or US-plug, guarantee a worldwide operation of the LED set. Due to the induction charging mechanism, the LED-candles do not have any electrical contacts. This feature, as well as their water resistance (not waterproof), make them ideal for outdoor use. Each tealight candle is equipped with a yellow shining LED and by skilfully switching between bright and dark, it achieves a deceptively real candle flickering effect. The rechargeable battery, which is integrated in the LED-candle, assures a lighting time of 20 hours with a charging time of about 8 - 9 hours and a lifetime of more than 500 charging cycles (this equates about 10.000 operating hours). The induction charging base, which is included in the set (item 8130), allows the charging of up to 12 LED-candles at the same time. Another plus is the integrated plug connection which allows to connect up to 4 charging bases to one single power supply. This enables the charging of up to 48 LED-candles with one electrical socket at the same time. One set (item 8130) includes 12 LED-candles and 1 induction charging base. The respective power supply (item 8132.EU/UK/US) needs to be ordered separately.

Bring the romantic atmosphere of candles to your own table - via modern LED technology!

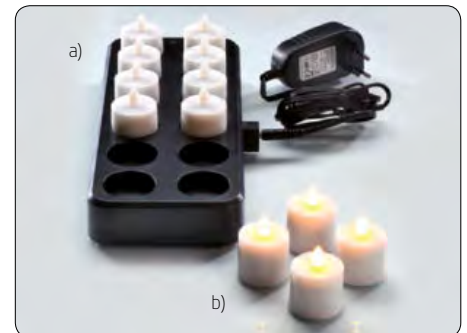

### a) LED-tealight set

plastic, set consists of one induction charging station black and 12 white LED-tealights (Ø 4 cm, 5 cm high, yellow light, flickering effect), delivery without power supply items 8132... (please order separately)

item	l x w x h in cm
8130	30.5x14x7.5

### b) LED-tealight

plastic, white, yellow light, flickering effect, for LED-tealight set item 8130

item	Ø in cm	height in cm	PU
8131	4	5	4 pcs

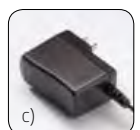
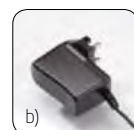

### power supply

for LED-tealight set item 8130, up to 4 LED-tealight sets (total of 48 candles) can be connected using 1 power supply only

item	version
a) 8132.EU	Europe
b) 8132.UK	UK
c) 8132.US	USA



Room service  
Guest rooms



"Solid"



More items of the series "Solid" for the buffet are available on pages 104 to 119.



**buffet platter, grey glass, 2/1 GN**

hardened glass, 10 mm thick, dark grey, edges polished and deburred

item	l x w in cm
8004.07B	65x53

**The tray stand of the series "Solid" convinces in every aspect!**

The shapely stand always provides the appropriate possibility to set up the "Solid" room service tray (item 4735) in the hotel room, but also in the restaurant. Combined with Zieher buffet platters in the format 2/1 GN, the stand easily and flexibly creates new spaces at a comfortable height. It is predestined for the use at the buffet as well as for the use during coffee breaks in the congress and convention business. The massive frame made of walnut wood harmonizes perfectly with other buffet items of the series (pages 104 to 119) and can be combined with them very well. Anti-slip rubber feet on the top prevent the shifting of platters and trays, felt gliders at the base protect the parquet flooring and ensure safe standing.

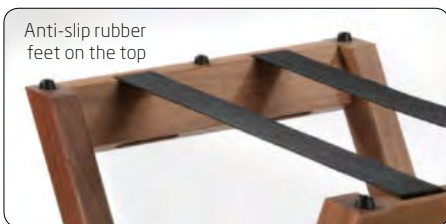

Anti-slip rubber feet on the top



Felt gliders at the base



**tray stand/side table "Solid"**

walnut, with black nylon ribbons, anti-slip rubber feet on top and felt gliders at the bottom, for trays and buffet platters in sizes starting from 55 cm x 36 cm, 102 cm high (folded up), 87 cm high (opened)

item	l x w x h in cm (opened)
4748	54.5x36x87

# Breakfast in bed - Inroom dining!



## bed tray "Solid"

walnut, food-safe sealed, not dishwasher-safe, stackable, with feet, 2 handles, recessed on one side of the rim

item	l x w x h in cm (closed)	l x w x h in cm (set up)
4773	60x40x6.5	approx. 74x40x31



The rubber feet at the base are set back from the rim to enable the transport on a tray trolley in 1/1 EN-format (60 cm x 40 cm).



## room service tray "Solid"

walnut, food-safe sealed, not dishwasher-safe, stackable, recessed on one side of the rim, with 2 handles, with 4 rubber feet, suitable for tray stand "Solid" item 4748

item	l x w x h in cm
4735	60x40x5.4

The room service tray as well as the "Solid" bed tray stand out due to the precious walnut, which is incorporated into these products with high-quality craftsmanship. The recessed longside enables comfortable dining directly off the tray. The retractable feet of the bed tray have been constructed in a very stable way and are securely kept in position by integrated magnets when folded in. The height of the erected tray has been chosen in a way that even with soft mattresses, a comfortable seating beneath the tray is guaranteed. So start off the day with a boundlessly relaxing breakfast in bed!



The recessed longside of the room service tray simplifies comfortable dining directly off the tray.



# "Solid"



Hotelcosmetic: PAM Berlin Slipper & Hotel Supplies - [www.pam-berlin.de](http://www.pam-berlin.de)



1

## 1 storage/presentation box "Solid"

walnut, food-safe sealed, not dishwasher-safe, with sliding lid made of wood, also useable with glass lid item 4762.18G (please order separately)

item	l x w x h in cm	size inside in cm
4762.18	18x18x6	approx. 16x16x4.2



## serving tray "Solid"

walnut, food-safe sealed, not dishwasher-safe, with 4 rubber feet

item	l x w x h in cm	l x w in cm (inside)
4713	34x34x3	32x32



## cutlery/napkin box "Solid"

walnut, food-safe sealed, not dishwasher-safe, with rubber feet in the lid (soft closure, can be opened to an angle of 90° only) and at the bottom, with black felt insert, stainless steel platter with space for an engraving (price and quantity upon request), height with open lid: 15.5 cm

item	l x w x h in cm	size inside in cm
4766	28.8x11.8x6	26x8.7





**2 glass lid**

hardened glass, brown tinted, with recess, for storage/presentation box "Solid" item 4762.18

item	l x w in cm
4762.18G	17.3x16.7

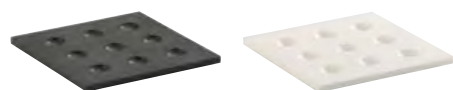

**3 insert for chocolates**

solid surface material, with 9 cavities (Ø 2.2 cm), for storage/presentation box "Solid" item 4762.18

item	colour	l x w x h in cm
4763.01S	black	15.8x15.8x1
4763.01W	white	15.8x15.8x1

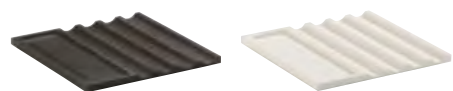

**4 insert for cigars**

solid surface material, for 4 cigars (grooves 1.9 cm wide), storage area for accessories (14.8 cm x 4.8 cm), for storage/presentation box "Solid" item 4762.18

item	colour	l x w x h in cm
4763.02S	black	15.8x15.8x1
4763.02W	white	15.8x15.8x1

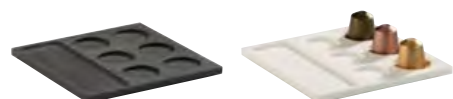

**5 insert for coffee capsules**

solid surface material, with 6 cavities (Ø 3.8 cm), storage area for accessories (14.8 cm x 4.8 cm), for storage/presentation box "Solid" item 4762.18

item	colour	l x w x h in cm
4763.03S	black	15.8x15.8x1
4763.03W	white	15.8x15.8x1



**6 insert/platter**

solid surface material, white, usable area: 14.8 cm x 14.8 cm, for storage/presentation box "Solid" item 4762.18

item	l x w x h in cm
4763.04W	15.8x15.8x1

1 + 2 + 3



1 + 2 + 5

**Delicacies in delicate setting!**

Due to the comprehensive range of accessories, the "Solid" presentation box offers multiple application possibilities. The box, regularly fitted with a wooden sliding lid, can be equipped with several optionally available inserts made of top-quality solid surface material. The also available lid made of brown-tinted glass puts the presented goods in the limelight.

Apart from an insert with round cavities for nine truffles/chocolates and a flat plate which can be used for layered chocolates, various little somethings or amuse bouches, there is also an insert available for commercial coffee capsules. The insert for cigars can hold up to four cigars and a separate compartment aside offers additional space for matches, cigar cutters, etc. No matter if it is an assortment of coffee specialities or various delicacies of the pâtisserie, the presentation box by Zieher provides the perfect setting for many purposes.



1 + 2 + 6



1 + 2 + 4



1 + 2



1 + 2 + 5



# "Solid"



This service tray with integrated separations is perfectly suitable for the service of small dishes at the pool, the beach or in the room.



## servicing tray "Solid"

walnut, food-safe sealed, not dishwasher-safe, stackable, 2 compartments: 30 cm x 30 cm and 30 cm x 8 cm (for cutlery or china/glass bowls), with 4 rubber feet

item	l x w x h in cm
4769	41.7x32.5x6.7

The major compartment has been designed for plates with a max. diameter of up to 29 cm, the lateral separation offers sufficient space for cutlery and napkin. Also insertion bowls with a max. width of 7.5 cm find space and thus can be used for dips, salad and other side dishes. You will find a selection of suitable inserts on page 260.

The trays are equipped with integrated grip holes respectively recessed grips and they are stackable. Finger joints at the corners, non-skid rubber feet and a food-safe sealing of the solid walnut wood fulfill the high quality standards which are valid for all items of the "Solid" range.

The plates and cloches of the series "Cuspis" are available on page 144 and 145.



## servicing tray "Solid"

walnut, flat, food-safe sealed, not dishwasher-safe, with 2 recessed grips, with 4 rubber feet, in black gift box

item	l x w x h in cm	l x w (inside) in cm
4707.PB	53x37x4	50.2x34.2



## glass platter

special hardened safety glass, 4 mm thick, rectangular, rounded edges, polished rim, dishwasher-safe, rubber feet included (adhesive), underside scratch-proof, for serving tray "Solid" items 4707.PB and 4740

item	version	l x w in cm
1668.03	black glass	50x34
1670.03	white glass	50x34



Extraordinary storage places ...  
... for extravagant guestrooms!

"Donna"



The china pillow "Donna" is available on page 151.



### glass pillow "Donna"

glass, satined, in black gift box

item	l x w x h in cm
5446.01PB	16.5x11x3



## Bedded on glass

This variant of the "Donna" pillow is made of frosted glass and despite its hard and massive raw material it surprises by its pleasantly soft and velvety feel.

The organic shape of this extraordinary piece offers an ideal presentation area for extravagantly staged intermediate courses or serves as a fancy place to keep all sorts of small objects of everyday life. Even when used as a soap dish, the pillow cuts a good figure. A version made of porcelain is available on page 151.



### wooden pillow "Donna"

solid walnut, oiled, not dishwasher-safe, 4 rubber feet, in black gift box

item	l x w x h in cm
4772.33PB	33.5x22.5x7



## Bedded on wood

Made of solid wood, milled with dedication and refined with high quality oils!

This sculpture of solid walnut, one of the finest European varieties of wood, has its own appearance. The sealing with oils emphasises the striking grain of the wood and gives the surface a silk-matt gloss as well as amazing haptics.

One just has to touch the softly curved forms of this hand charmer. Whether used as a fruit bowl, as a place to keep accessories or as sculptural decoration - "Donna" seduces in every material!



The platter "Collina" is available on page 153.



# "Podia"

The fruit bowl "Sixth Sense" item 2171.02 is available on page 83.



Please note: by reason of manufacturing, deviations from the declared measurements of the bridges may occur!



## buffet bridge "Podia", triple pack

genuine wood veneer, light colouring (similar to oak), not dishwasher-safe

item	w x d x h in cm	PU
8731	30x20x6 (1st bridge)	1 set
	36x20x9 (2nd bridge)	
	42.5x20x12 (3rd bridge)	



## In-Room Dining

The buffet bridges and trays of the "Podia" series offer several advantages! They are light but robust, flexibly usable and can be stored in a space-saving way. With its use as a display on the buffet, during coffee break or as a platter for fruit or little somethings in the hotel room - "Podia" offers multiple possibilities for use and flexible handling. The tray in 1/2 GN format is especially suitable for different miniatures made of porcelain and glass. Slide-proof silicone coasters in different styles (page 209) guarantee a good grip during service. All parts of this series consist of form-glued authentic wood veneer. The bridges are available in two types of wood. The light version harmonizes very well with mundane but also with rustic-style furnishing, the version with the black-brown stripes appears exotic and modern.



## buffet bridge "Podia", triple pack

genuine wood veneer, dark (black-brown striped), not dishwasher-safe

item	w x d x h in cm	PU
8730	30x20x6 (1st bridge)	1 set
	36x20x9 (2nd bridge)	
	42.5x20x12 (3rd bridge)	



## 1/2 GN tray "Podia"

genuine wood veneer, dark (black-brown striped), not dishwasher-safe

item	l x w in cm	GN	PU
8732.03	32.5 x 26.5	1/2	6 pcs

Hotelcosmetic:  
PAM Berlin Slipper & Hotel Supplies -  
www.pam-berlin.de

# Etagere "DressCoat"



## etagere "DressCoat"

massive stainless steel 18/10, hammered, polished, 3-armed

item	Ø in cm	height in cm
2212.30	36	30

Please note: We recommend the use of large plates on the lower level only.



## glass plate "Unique"

glass, white marbled, bottom satined, round

item	Ø in cm	PU
5178.21	21	6 pcs
5178.28	28	6 pcs



## glass plate "Unique"

glass, black marbled, bottom satined, round

item	Ø in cm	PU
5179.21	21	6 pcs
5179.28	28	6 pcs



The etagere with three tiers, made of hammered and highly polished stainless steel, forms an extravagant basis for many sorts of plates and platters. Even in the hotel room, the etageres can be positioned in an eye-catching way. Equipped with "DressCoat" (item 4388, page 94) or other tableware, small snacks, a selection of fruit or a sweet welcoming treat can be staged in an appealing way. All information about this etagere is available on page 94.

The plateau plate item 4388 and more items of the "DressCoat" series are available on page 148.







"From the merely comparable to the extraordinary" was the guiding principle during the development of the "Kibu" coat rack. The rack is made of massive European hardwood and has a dark brown hue. The bottom plate made of 8 mm strong, satined stainless steel creates a pleasing cool contrast to the warm aura of the solid wood and simultaneously provides a very safe and steady base. The 16 bolts, which can be used to hang many jackets and other pieces of clothing, are also made of stainless steel, relating to the material of the base. Rolling lines and surfaces unite harmoniously and fit unobtrusively to every style of furnishing. Offering a high degree of functional usefulness, combined with extraordinary design - "Kibu" is both an item of daily use and a design feature.

**coat rack "Kibu"**

solid wood, dark stained, foot: stainless steel (brushed), adjustable base for firm positioning on most surfaces

item	Ø in cm	height in cm
7700	60	210

Inspirations for roomservice + interieur...



"Capiz", page 71



Bento-Tray, page 122



"Splash", page 63



"Slope", page 228



"Reef", page 67



"Matrix", page 68

## quick-finder - list of items in ascending order

item	description	page
0405.1388	miniature fork "Europa"	226
1501	cork	136, 212
1502	cork	253
1668.01	buffet platter, black glass	50
1668.03	buffet platter, black glass	50, 110, 234, 276
1668.04	buffet platter, black glass	50
1668.05	buffet platter, black glass	50
1668.06	buffet platter, black glass	50, 182
1668.08	buffet platter, black glass	50, 58, 99
1668.09	buffet platter, black glass	50
1668.10	buffet platter, black glass	50, 169, 182
1668.12	buffet platter, black glass	50, 98
1668.14	buffet platter Curve 45°	50
1668.15	buffet platter Curve 90°	50
1668.20	buffet platter, black glass	50, 104
1669.33	charger plate, black glass	50, 116, 177, 182
1669.53	buffet platter, black glass	50
1670.01	buffet platter, white glass	51
1670.03	buffet platter, white glass	51, 110, 234, 276
1670.04	buffet platter, white glass	51
1670.06	buffet platter, white glass	51, 182
1670.08	buffet platter, white glass	51, 58, 99
1670.09	buffet platter, white glass	51
1670.10	buffet platter, white glass	51, 169, 182
1670.12	buffet platter, white glass	51, 98
1670.14	buffet platter Curve 45°	51
1670.15	buffet platter Curve 90°	51
1670.20	buffet platter, white glass	51, 104
1671.33	charger plate	51, 71, 116, 177, 182
1671.53	buffet platter, white glass	51
1938	party spoon	134, 226
1938.01	party spoon	134, 226
1939.01	skewer	92, 135, 225, 226
1939.02	skewer	92, 135, 225, 226
1939.04	small skewer "Flame"	156, 225, 226
2056	cruet stand for inserts up to 5 cm x 5 cm	256
2056.01	cruet stand for inserts up to 7 cm x 7 cm	256
2056.02	cruet stand for inserts up to 4 cm x 4 cm	256
2057	tray	251, 256
2058	"Ménage-à-trois"	255
2101.17	tray	97, 249
2105.03	etagere	97, 249
2107.03	etagere	96, 248
2107.04	etagere	96, 248
2109	bowl "Loop"	83
2110	etagere	95, 250
2110.01	tray	95, 250
2115	tongs holder	101
2116.32	bowl	88
2116.41	bowl	88
2116.71	bowl	88
2119	buffet etagere	98
2119.01	tray	98
2119.02	buffet etagere	98
2120.15	bowl "Medusa"	81
2120.15PB	bowl "Medusa"	81
2120.25	bowl "Medusa"	81
2120.25PB	Schale "Medusa"	81
2120.38	bowl "Medusa"	81
2121.22	bread/pastry bowl	84
2123	presentation tray/buffet bowl	88
2125.24	tray	84

item	description	page
2125.36	tray	84
2130	bowl	88
2132	buffet bowl	86
2133.12	bread/pastry bowl	84, 223
2136	pastry tray	95, 250
2138	chocolate/ice cube tongs	101, 237
2139	serving tongs	101
2140	serving tongs	101
2141.01	buffet stand	86
2141.02	buffet stand	86
2141.03	buffet stand	86
2153	small bowl	84, 223
2153.01	small bowl	84, 223
2154	spoon rest	101
2159.16	bowl	84, 223
2159.16PB	bowl	84, 223
2159.20	bowl	84, 223
2159.20PB	bowl	84, 223
2160.66	sushi tray	95
2163	champagne bowl	87
2167.15	holder coil shape	92
2167.20	holder coil shape	92
2167.25	holder coil shape	92
2167.30	holder coil shape	92
2169	bowl "Wings"	82
2169.01	bowl "Wings"	82
2169.02	bowl "Wings"	82
2170	bowl/basin XXL	87
2171	bowl "Sixth Sense"	83
2171.01	bowl "Sixth Sense"	83
2171.02	bowl "Sixth Sense"	83
2174	bowl	86
2177.10	buffet stand "Skyline"	18
2177.22	buffet stand "Skyline"	18
2177.34	buffet stand "Skyline"	18
2177.58	buffet stand "Skyline"	18
2178.23	fruit/bread basket "Skyline"	20
2179.10	fruit/bread basket "Skyline"	20
2179.22	fruit/bread basket "Skyline"	20
2179.34	fruit/bread basket "Skyline"	20
2180.09	bowl	85, 159, 223
2180.13	bowl	85, 159, 223
2180.22	bowl	85
2180.22PB	bowl	85
2180.30	bowl	85
2180.30PB	bowl	85
2180.40	bowl	85
2181.14	bowl	84
2181.17	bowl	84
2181.21	bowl	84
2181.24	bowl	84
2182.09	bowl	85, 159, 223
2182.13	bowl	85, 159, 223
2182.22	bowl	85
2182.30	bowl	85
2183	bowl	84
2184	buffet bowl	86
2187	etagere	85, 223, 244
2189	etagere/pastry stand	244
2189.PB	etagere/pastry stand	244
2190	toast rack	101, 250
2191.03	tray	226, 251
2191.04	tray	226, 251
2193	buffet etagere	99
2193.01	tray	59, 99
2193.02	buffet etagere	99
2194.03	food display	261
2194.06	food display	261

item	description	page
2197	etagere	82
2199.30	bowl	82
2199.40	bowl	82
2199.50	bowl	82
2200.PB	illuminated champagne bowl	87
2201	etagere with 3 tiers (each 7 miniature plates)	89, 246
2201.PB	etagere with 3 tiers (each 7 miniature plates)	89, 246
2202	etagere with 1 tier (7 miniature plates)	89, 246
2202.PB	etagere with 1 tier (7 miniature plates)	89, 246
2203.08	miniature plate with rod	93, 225
2203.13	miniature plate with rod	93, 225
2203.18	miniature plate with rod	93, 225
2203.23	miniature plate with rod	93, 225
2204.08	amuse gueule stand with foot	89, 224, 246
2204.11	amuse gueule stand with foot	89, 224, 246
2206.50	bowl flat	88
2206.50PB	bowl flat	88
2206.60	bowl flat	88
2207.11	ice cream cup with foot	89, 224, 246
2207.15	ice cream cup with foot	89, 224, 246
2208.13	etagere "Flower-Tree"	90, 247
2208.13PB	etagere "Flower-Tree"	90, 247
2208.25	etagere "Flower-Tree"	90, 247
2209.13	etagere "Flex-Tree"	91, 247
2209.25	etagere "Flex-Tree"	91, 247
2212.30	etagere "DressCoat"	94, 245, 279
2260.16	bowl "Shine"	62, 113
2260.20	bowl "Shine"	62
2260.24	bowl "Shine"	62
2261.16	bowl "Shine"	62, 113
2261.16PB	bowl "Shine"	62
2261.20	bowl "Shine"	62
2261.20PB	bowl "Shine"	62
2261.24	bowl "Shine"	62
2261.24PB	bowl "Shine"	62
2262.16	bowl "Shine"	62, 113
2262.20	bowl "Shine"	62
2262.24	bowl "Shine"	62
2310	bowl/basket "Reef"	67, 221
2311	bowl/basket "Reef"	67
2312.01	bowl/basket "Reef"	65
2312.02	bowl/basket "Reef"	65
2313.01	bowl/basket "Reef"	65
2313.02	bowl/basket "Reef"	65
2314.01	bowl/basket "Reef"	65
2314.01PB	bowl/basket "Reef"	65
2314.02	bowl/basket "Reef"	65
2314.02PB	bowl/basket "Reef"	65
2314.03	bowl/basket "Reef"	65
2314.03PB	bowl/basket "Reef"	65
2315.01	candle holder/wind light "Reef"	66, 269
2316.PB	candle holder/wind light "Reef"	66, 269
2317	napkin ring "Reef"	66, 161
2317.G	napkin ring "Reef"	66, 161
2317.GPB	napkin ring "Reef"	66, 161
2317.PB	napkin ring "Reef"	66
2318	small bowl/basket "Reef"	67, 221
2332	bowl/basket "Reef"	64
2334	bowl/basket "Reef"	64
2335	bowl/basket "Reef"	64
2336	bowl/basket "Reef"	64
2336.PB	bowl/basket "Reef"	64
2337	bowl/basket "Reef"	64
2340.15	bowl "Splash"	63
2340.15PB	bowl "Splash"	63



## quick-finder - list of items in ascending order

item	description	page	item	description	page	item	description	page
2340.22	bowl "Splash"	63	4326.11	small bowl	174, 216, 265	4588	GN tray	125, 262
2340.22PB	bowl "Splash"	63	4359	fondue set, 2 parts	156	4589	GN tray	125, 262
2340.28	bowl "Splash"	63	4375.01PB	bowl "Cave"	155, 217	4590	2/8 GN tray	128, 262
2340.28PB	bowl "Splash"	63	4380	plate "Modul"	134, 164, 219	4591	cutlery/napkin box	117, 124, 135
2340.38	bowl "Splash"	63	4381	bowl "Modul"	134, 164, 219	4593	2/8 GN tray	128, 262
2370.23	tray "Artisan"	79	4383	plate "Modul"	135, 164, 219	4594	cutlery box	117, 124
2370.28	tray "Artisan"	79	4384	bowl "Modul"	134, 164, 219	4595.30	tray "Slope"	229
2370.33	tray "Artisan"	79	4385.22	plate "Modul"	134, 164	4595.45	tray "Slope"	229
2371.07	bowl "Artisan"	78, 223	4385.27	plate "Modul"	134, 164	4597.01	chiller base/tray	40
2371.11	bowl "Artisan"	78, 223	4386	plateau plate "DressCoat"	148	4597.02	chiller base/tray	40
2371.14	bowl "Artisan"	78	4386.01	plateau plate "DressCoat"	91, 148, 216	4598.09	bowl/box	124
2371.16	bowl "Artisan"	78	4386.02	plateau plate "DressCoat"	91, 148, 216	4598.13	bowl/box	124
2371.21	bowl "Artisan"	78	4386.PB	plateau plate "DressCoat"	148	4599.13	bowl/box	124
2372	bread/pastry bowl "Artisan"	78	4387	plateau plate "DressCoat"	148	4606.10	miniature plate	91, 248
2373	bread/pastry bowl "Artisan"	78	4387.PB	plateau plate "DressCoat"	148	4606.17	plate	218, 249
2374.24	tray "Artisan"	79	4388	plateau plate "DressCoat"	94, 148	4607.10	miniature plate	91, 248
2376	etagere "Artisan"	79	4388.PB	plateau plate "DressCoat"	148	4607.17	plate	218, 249
2380.07	bowl/display "Fakir"	68, 266	4389.09	plateau plate/small bowl "Cuspis"	144, 172, 201	4660.01	non-slip mat	137
2380.12	bowl/display "Fakir"	68, 266	4389.11	plateau plate/small bowl "Cuspis"	144, 172, 201	4660.02	non-slip mat	137
2380.15	bowl/display "Fakir"	68, 266	4389.25PB	plateau plate/bowl "Cuspis"	144, 172	4660.03	non-slip mat	137
2380.18	bowl/display "Fakir"	68, 266	4458	dressing/jam jar	100	4661.05S	coaster	209
2381.38	bowl "Roots"	68	4461.02	porcelain pillow "Donna"	151	4661.05W	coaster	209
2381.38PB	bowl "Roots"	68	4461.03	porcelain pillow "Donna"	151, 216	4679.S	pedestal/ring, illuminable	77, 187
2382.38	bowl "Matrix"	68	4489	creamer	218, 252, 263	4680.S	holder for test tubes	136, 204, 212
2383.01	candle holder/wind light "Somnia"	8, 268	4490	miniature	92, 204, 218, 252, 263	4680.W	holder for test tubes	136, 204, 212
2384.PB	candle holder/wind light "Somnia"	268	4490.01	miniature	92, 204, 218, 252, 263	4681.S	ring "SelectionA."	57, 77, 158, 209, 215
2385.01	display for bowls "Somnia"	8	4491	charger plate "SelectionA."	158	4681.W	ring "SelectionA."	57, 77, 158, 209, 215
2385.02	display for bowls "Somnia"	8	4492	charger plate "SelectionA."	158	4682.S	ring "SelectionA."	77, 158, 189
2386.10	buffet display "Somnia"	8	4493.19	plate "SelectionA."	158	4682.W	ring "SelectionA."	77, 158, 189
2386.20	buffet display "Somnia"	8	4493.24	plate "SelectionA."	158, 175	4683	silicone sleeve	98
2543.30	charger plate, slate	47, 180	4495	plate "SelectionA."	158	4684	silicone sleeve	19, 24
2544.30	charger plate, slate	47, 180	4498	small bowl	218, 253, 255, 263	4685	protecting cap	8
2779	salt & pepper mill set	259	4499	small bowl "Catering"	218, 253, 255, 263	4700	coaster "Solid"	175, 240
3461	card holder	100	4500	small bowl "Catering"	218, 255, 263	4700.01	saucer "Solid"	175, 240, 270
3466.02	cruet stand	252	4501	platter "Collina"	153	4703	box "Solid" for inserts up to 5 x 5 cm	238, 258
3467.02	tray for inserts up to 5 cm x 5 cm	257	4501.PB	platter "Collina"	153	4704	box "Solid" for inserts up to 7 cm x 7 cm	238, 258
3468.02	cruet stand	253	4502	platter "Collina"	153	4705	box "Solid"	238
3469.02	tray for inserts up to 7 cm x 7 cm	257	4503	platter "Collina"	153	4707.PB	servicing tray "Solid"	110, 234, 276
3844	small bowl	218, 259	4504	platter "Collina"	153	4708	tray "Solid"	238, 258
3845	small bowl	136, 218, 259	4504.PB	platter "Collina"	153	4708.G	glass insert/coaster	238, 258
3845.01	small bowl	218, 259	4505	plate "Velo"	151	4710	servicing tray "Solid"	116, 239
3849	small creamer	218, 259	4505.01	plate "Velo"	151	4711.18	bowl "Solid"	116, 239
3853	small bowl	136, 218, 260	4506	plate "Dots"	154	4711.24	bowl "Solid"	116, 239
3854	small bowl	218, 260	4507.01PB	plate/platter "Pulsar"	142	4711.30	bowl "Solid"	116, 239
3854.01	small bowl	218, 260	4507.02PB	plate/platter "Pulsar"	142	4713	servicing tray "Solid"	114, 234, 274
3855	small bowl	218, 259	4563	china ball "oro79"	162	4716	tealight holder "Solid"	270
3855.01	small bowl	204, 218, 259	4564.26	plate "oro79"	162	4718	tray stand "Solid"	108
3858	small bowl	154, 218	4565.35	plate "oro79"	162	4719	tray "Solid" for inserts up to 5 cm x 5 cm	238, 258
3859	small bowl	154, 218	4567.24	plate "Roughl"	6, 160, 242	4720	cutlery box "Solid"	117, 129, 235
3912	dip bowl "Twist" for olive oil	136	4578	Bento Box	122, 230	4721	base tray "Modul"	130
3954.21	coup plate "Catering"	6, 160, 242	4579	lid/tray	122, 230	4722	base tray "Modul"	58, 130
3954.23S	coup plate "Catering"	6, 160, 242	4580	insert/box	122, 124, 230	4723	base tray "Modul"	130
4032.G	test tube	136, 212	4581	base tray "Modul"	125, 132	4724	bridge "Modul"	130
4076	table display	100	4582	base tray "Modul"	58, 125, 132	4725	spoon rest "Modul"	130
4081.12	bowl	128, 216, 263, 265	4583	base tray "Modul"	125, 132	4726	card holder	100, 116, 239
4093	small creamer	216	4584	bridge "Modul"	128, 132	4730	bridge "Solid"	113
4260.01	amuse gueule/tapas spoon	135, 226	4585	spoon rest "Modul"	128, 132, 135, 262	4731	bridge "Solid"	113
4260.03	amuse-gueule/tapas spoon "Modul"	135, 164, 226	4586	tray	125, 262	4732.PB	cutting board "Solid"	112
4281	bowl "Catering de Luxe"	113, 156	4587	GN tray	125, 262	4733	bread cutting board "Solid"	112
4281.01	bowl "Catering de Luxe"	156				4733.R	replacement grate "Solid"	112
4281.02	bowl "Catering de Luxe"	156						
4281.03	bowl "Catering de Luxe"	156						
4281.04	bowl "Catering de Luxe"	156						
4324.11	miniature plate	174, 216, 248						

## quick-finder - list of items in ascending order

item	description	page	item	description	page	item	description	page
4734.01	coaster "Solid"	119, 176, 241	4850	glass cloche	118, 177, 241	4943.08PB	cloche with plateau plate/small bowl "Cuspis"	144, 172, 201
4734.02	coaster "Solid"	119, 176, 241	4851	glass cloche	118, 177, 241	4943.10PB	cloche with plateau plate/small bowl "Cuspis"	144, 172, 201
4734.03	coaster "Solid"	119, 176, 241	4852	glass cloche	104, 118, 177, 241	4943.25PB	cloche with plateau plate/small bowl "Cuspis"	144, 172
4734.04	coaster "Solid"	119, 176, 241	4853	glass cloche	178	4945	decanter/carafe "Star" - mini	184
4735	room service tray "Solid"	114, 232, 273	4854.01	glass stand	178	4945.PB	decanter/carafe "Star" - mini	184
4736	walnut connector "Squareline"	24	4854.02	glass stand	178	4946.PB	decanter/carafe "Star" - mini with Vision "Straight"	184
4737	chocolate/truffle box "Solid"	237	4854.03	glass stand	178	4947	decanter/carafe "Star"	185
4738	chocolate/truffle box "Solid"	237	4859.07	small glass bowl	67, 159, 169, 221	4948.PB	decanter/carafe "Star" with base	185
4740	serving tray "Solid"	111, 234	4860.07	small glass bowl	67, 159, 169, 221	4954.01	small glass bowl "Halfmoon"	211, 265
4741	grate insert "Solid"	111	4880.18	glass cloche	119, 143, 176, 241	4954.02	small glass bowl "Halfmoon"	211, 253, 255, 263
4742	tray insert "Solid"	110	4880.22	glass cloche	119, 176, 241	4954.03PB	small glass bowl "Halfmoon"	211
4743	tray insert "Solid"	110	4880.26	glass cloche	104, 119, 143, 176, 241	4956.01	glass bowl	211, 265
4744	cutlery insert "Solid"	111	4880.30	glass cloche	119, 176, 241	4956.02	glass bowl	211
4745	tray insert "Solid"	111	4881.26	wine cooler	57	4956.02PB	glass bowl	211
4746	tray stand "Solid"	108	4882.22PB	cloche with wooden coaster and glass insert	119, 241	4956.03	glass bowl	211
4747	connector piece "Solid"	108	4882.30PB	cloche with wooden coaster and glass insert	119, 241	4956.03PB	glass bowl	211
4748	tray stand/side table "Solid"	272	4883	decanter/carafe "Eddy"	189	4956.04	glass bowl	211
4749	ham holder "Solid"	113	4884.PB	decanter/carafe "Eddy" with ring	189	4956.04PB	glass bowl	211
4760	bowl "Solid"	116, 239	4885	chopsticks	168, 202	4962	cocktail glass	210, 265
4761	bowl "Solid"	116, 239	4886	chopstick/knife rest "Flex"	168, 202	4963.01	small glass bowl	211
4762.18	storage/presentation box "Solid"	236, 274	4887.PB	chopsticks with knife rest	168, 202	4963.02	small glass bowl	211
4762.18G	glass lid	236, 275	4888.16	platter/miniature "Flex"	202	4964	small glass bowl "Halfmoon"	211
4763.01S	insert for chocolates	236, 275	4888.22	platter/miniature "Flex"	202	4965	glass bowl	208, 215
4763.01W	insert for chocolates	236, 275	4889.16	dip bowl/miniature "Flex"	202	4980.12	glass straw	210
4763.02S	insert for cigars	236, 275	4890	decanter/carafe „Pebble"	190	4980.16	glass straw	204, 210
4763.02W	insert for cigars	236, 275	4890.PB	decanter/carafe "Pebble"	190	4982	glass cloche	175, 240
4763.03S	insert for coffee capsules	236, 275	4891	decanter/carafe "Eddy" - mini	188	4982.05	glass cloche	102, 174
4763.03W	insert for coffee capsules	236, 275	4891.PB	decanter/carafe "Eddy" - mini	188	4982.06	glass cloche	174
4763.04W	insert/platter	236, 275	4892.PB	decanter "Star" with Vision "Straight"	188	4982.07	glass cloche	174
4766	cutlery/napkin box "Solid"	235, 274	4901.01	glass miniature	210	4982.09	glass cloche	175, 240
4767.12	buffet display "Solid"	36, 117, 130	4901.02	glass miniature	210	4982.11	glass cloche	175
4767.24	buffet display "Solid"	36, 117, 130	4901.03	glass miniature	92, 102, 210, 252	4984	vinegar/oil bottle	254
4768.08	buffet display/basket "Mercato"	106	4903	glass miniature	210, 263	4985	vinegar/oil bottle	254
4768.12	buffet display/basket "Mercato"	106	4907	glass tumbler	210, 255, 263	4987.01	wind light	175, 240, 270
4768.16	buffet display/basket "Mercato"	106	4910	glass bowl	136, 214	4991.02	wind light	8, 66, 268, 269, 270
4769	serving tray "Solid"	114, 129, 232, 276	4914	glass miniature "Amuse"	207	4995	small glass creamer	208
4770.24	bread basket "Solid"	239	4914.PB	glass miniature "Amuse"	207	4999	charger plate/glass insert	52, 116, 182
4772.33PB	wooden pillow "Donna"	150, 277	4915	glass miniature "Amuse"	207	5000	buffet platter, clear glass	52
4773	bed tray "Solid"	114, 233, 273	4915.PB	glass miniature "Amuse"	207	5013.46	buffet bowl	75
4774.31PB	cutting/snack board "Connect!"	115, 230	4918.PB	glass tin "Amuse"	206	5014.38	buffet bowl	75
4775.44PB	cutting/snack board "Connect!"	115, 230	4919.PB	glass tin "Amuse"	206	5016.24	glass bowl	166, 175
4776	cutting board "Solid"	104, 112	4920	glass tin "Amuse"	206, 265	5021.01	glass platter/tray	73, 165
4776.PB	cutting board "Solid"	104	4920.PB	glass tin "Amuse"	206	5021.02	glass platter/tray	73, 165, 180
4777	stacking ring "Solid"	104	4921	glass tin "Amuse"	206	5021.03	glass platter/tray	73, 165
4778	bowl "Solid"	104	4921.PB	glass tin "Amuse"	206	5024.45	buffet bowl	75
4780.46	serving tray "Solid"	115, 231	4922	small glass creamer "Amuse"	208, 265	5026.01	glass steps	54
4780.46S	serving tray	115, 231	4923	nut bowl "Amuse"	208, 265	5026.02	glass steps	54
4780.67	serving tray "Solid"	115, 231	4923.PB	nut bowl "Amuse"	208	5026.03	glass steps	54
4780.67S	serving tray	115, 231	4925.01	cone "Lacuna"	205	5026.04	glass steps	54
4810.01	bowl	70	4926.01	small glass, bowl "Lacuna"	205	5034.01	glass miniature plate	174, 220
4810.02	bowl	70	4930	small glass bowl	67, 209, 215, 221	5037	glass miniature plate	91, 220
4811.01	bowl	70	4940.08	glass cloche "Cuspis"	144, 172, 201	5039	small glass bowl	220
4811.02	bowl	70	4940.10	glass cloche "Cuspis"	144, 172, 201	5039.01	small glass bowl	174, 220
4813.28	glass bowl "Duplex"	77	4940.25	glass cloche "Cuspis"	144, 172	5049.35	buffet bowl	75
4813.35	glass bowl "Duplex"	77	4941.01	glass spoon "Cuspis"	200, 226	5063	glass platter	75, 170
4813.46	glass bowl "Duplex"	77	4942.01	honey spoon "Cuspis"	200, 220, 226	5063.50	glass platter	75, 170
4814.17	glass bowl	8, 10, 77, 159, 215				5064	glass platter	170
4814.23	glass bowl	8, 10, 77				5075.40	buffet platter	170
4814.30	glass bowl	8, 10, 77				5076.01	glass steps	54
4814.40	glass bowl	8, 10, 77				5084	glass platter	170
4815.18	glass bowl "Cave"	77, 155				5099	small glass bowl	220
4815.24	glass bowl "Cave"	77, 155				5141.34	glass tray	54, 165, 264
						5141.50	glass tray	54, 165, 264



## quick-finder - list of items in ascending order

item	description	page
5142.34	glass tray	54, 165, 264
5143	glass tray	165, 264
5145	glass tray	165, 174, 264
5160.31	glass tray	59, 75
5160.62	glass tray	59, 75
5161.31	glass tray	59, 75
5161.62	glass tray	59, 75
5166	glass bowl	67, 221
5167	small glass bowl/glass tray	200, 220
5168.06	spoon rest/glass miniature	100, 167
5168.14	glass platter/plate	167
5168.25	glass platter/plate	167
5168.30	glass platter/plate	167
5169.31	glass platter/plate	167
5169.38	glass platter/plate	167
5169.41	glass platter/plate	167
5172	small glass bowl/spoon rest	100, 220
5173	small glass bowl	220
5175.41	glass bowl	73
5175.44	glass bowl	73
5176	buffet bowl	14, 73, 120, 278
5177.20	glass plate	167
5177.25	glass plate	167
5177.28	glass plate	167
5178.16	glass plate "Unique"	146, 249
5178.21	glass plate "Unique"	94, 146, 245, 279
5178.28	glass plate "Unique"	146, 245, 279
5178.32	glass plate "Unique"	146
5179.16	glass plate "Unique"	147, 249
5179.21	glass plate "Unique"	94, 147, 245, 279
5179.28	glass plate "Unique"	147, 245, 279
5179.32	glass plate "Unique"	147
5180.10	glass bowl "Unique"	146, 214
5180.15	glass bowl "Unique"	146
5181.10	glass plate "Unique"	147, 214
5181.15	glass plate "Unique"	147
5182.16	glass bowl "Unique"	70, 146
5182.21	glass bowl "Unique"	70, 146
5182.27	glass bowl "Unique"	70, 146
5183.16	glass bowl "Unique"	70, 147
5183.21	glass bowl "Unique"	70, 147
5183.27	glass bowl "Unique"	70, 147
5190	platter/plate "Pulsar"	143, 176
5210	ashtray for cigars	100, 215, 266
5240.M	buffet platter/separating plate	38, 52, 87
5241	buffet platter Curve 90°	52
5242	buffet platter Curve 45°	52
5243	buffet platter, clear glass	52, 58, 99
5243.M	buffet platter, satined glass	52, 58, 99
5244	coaster/glass insert	68, 175, 214, 240, 266
5244.11	coaster/glass insert	68, 214, 266
5244.17	coaster/glass insert	68, 119, 176, 241, 266
5244.21	coaster/glass insert	68, 119, 176, 241, 266
5244.24	coaster/glass insert	68, 119, 176, 241, 266
5244.28	coaster/glass insert	68, 119, 176, 241, 266
5254	small bowl	136, 154, 213
5254.01	glass miniature	154, 213
5255	small glass creamer	154, 213
5257	glass miniature	136, 215
5290.01	glass bottle	213

item	description	page
5290.02	glass bottle	213, 263
5295.01	glass bottle	213, 259
5295.02	glass bottle	213, 260
5296.01	glass bottle	213, 259
5296.02	glass bottle	213, 259
5297.01	cork	213, 259
5297.02	cork	213, 259
5308.08	glass bowl	170, 214
5308.11	glass bowl	170, 214
5308.20	glass bowl	170
5308.26	glass bowl	170
5317	vinegar/oil bottle	253
5330.08	glass bowl	170, 214
5330.20	glass bowl	170
5330.24	glass bowl	170
5330.29	glass bowl	170
5338	small glass bowl	154, 213, 260
5338.01	glass miniature	154, 213, 260
5347	caviar set	170
5349.21	pastry/cake stand	118, 177
5349.28	pastry/cake stand	118, 177
5349.33	pastry/cake stand	118, 177
5350.16	glass cloche	118, 177
5350.23	glass cloche	118, 177
5350.27	glass cloche	118, 177
5351	vinegar/oil bottle	253
5352	glass carafe	170
5380	glass	152, 215, 263, 265
5381	glass	152, 215, 263, 265
5405	glass miniature	92, 136, 204, 215, 252
5415	glass cone	102, 214, 261
5416	small glass creamer	212
5418	small glass bowl/cloche	152, 159, 178, 215
5420	glass miniature	212, 253, 255, 263
5420.01	glass miniature	212, 253, 255, 263
5423.01	glass miniature	136, 212
5423.02	glass miniature	136, 212
5424	small butter & lard pot	213
5428.04	glass tray	214, 251
5441	glass bowl "Duo"	215, 265
5444	glass bowl	128, 215, 263, 265
5445	glass miniature, 2 parts	212
5446.01PB	glass pillow "Donna"	150, 216, 277
5480.01	FRESH	194
5480.01-1	FRESH	194
5480.02	STRAIGHT	194
5480.02-1	STRAIGHT	194
5480.03	INTENSE	194
5480.03-1	INTENSE	194
5480.04	BALANCED	195
5480.04-1	BALANCED	195
5480.05	RICH	195
5480.06	NOSTALGIC	195
5480.07	SIDE	195
5480.07-6	SIDE	195
5481	champagne flute "Vaganza"	198
5481.GPB	champagne flute "Vaganza"	198
5481.PPB	champagne flute "Vaganza"	198
5482.10	glass cloche	142, 179
5482.10PB	glass cloche	142, 179
5482.15	glass cloche	142, 179

item	description	page
5660	hook-and-loop strap	103
5662	hand pump	38, 87
5663.20	cooling pack	40, 155, 217
5665.01	storage/transportation box	11
5665.02	storage/transportation box	11
5700	glass plate	76, 166
5701	glass bowl	76, 166
5702	glass plate	76, 166
5703	buffet bowl	76, 166
5704	buffet bowl	74
5740	glass bottle/creamer	213, 254, 259
5741	miniature glass bottle	212, 254
5760.35	charger plate "Ice"	163, 180
5761.33	charger plate "Ice"	163, 180
5762.16	glass platter "Ice"	163
5762.33	glass platter "Ice"	163
5762.40	glass platter "Ice"	163
7100.36	charger plate "Capiz"	180
7106.46	bowl "Capiz"	71
7109.46	bowl "Capiz"	71
7109.46PB	bowl "Capiz"	71
7112.36	bowl "Capiz"	71
7700	coat rack "Kibu"	280
8001.01	buffet platter "Vintage"	49
8001.02	buffet platter "Vintage"	49
8001.04	buffet platter "Vintage"	49
8001.06	buffet platter "Vintage"	49, 182
8001.08	buffet platter "Vintage"	49, 58, 99
8001.11	buffet platter "Vintage"	49
8001.13	buffet platter "Vintage"	49
8004.01	buffet platter, clear glass	52
8004.02	buffet platter, clear glass	52
8004.03	buffet platter, clear glass	52
8004.04	buffet platter, clear glass	52
8004.05	buffet platter, clear glass	52
8004.06	buffet platter, clear glass	52
8004.07B	buffet platter, dark grey glass	53, 272
8005.01	buffet platter, slate	47
8005.02	buffet platter, slate	47
8005.04	buffet platter, slate	47
8005.05	buffet platter, slate	47
8005.06	buffet platter, slate	47
8005.07	buffet platter, slate	47
8005.21	buffet platter, slate	47
8006.01	buffet platter, laminated plastic	48
8006.02	buffet platter, laminated plastic	48
8006.04	buffet platter, laminated plastic	48
8006.06	buffet platter, laminated plastic	48, 182
8006.08	buffet platter, laminated plastic	6, 48, 58, 99, 242
8006.11	buffet platter, laminated plastic	48
8006.13	buffet platter, laminated plastic	48
8006.14	buffet platter, laminated plastic	6, 48, 242
8006.15	buffet platter, laminated plastic	6, 48, 242
8007.01	buffet platter "Industry 2.0"	49
8007.02	buffet platter "Industry 2.0"	49
8007.04	buffet platter "Industry 2.0"	49
8007.06	buffet platter "Industry 2.0"	49, 182
8007.08	buffet platter "Industry 2.0"	49, 58, 99
8007.11	buffet platter "Industry 2.0"	49
8007.13	buffet platter "Industry 2.0"	49
8008.01	buffet platter	53
8008.02	buffet platter	53
8008.03	buffet platter	53
8008.04	buffet platter	53
8008.05	buffet platter	53
8008.06	buffet platter	53, 182
8008.07	buffet platter	53

## quick-finder - list of items in ascending order

item	description	page
8008.08	buffet platter	53, 58, 99
8008.13	buffet platter	53
8011.12	buffet stand "Antique"	42
8011.24	buffet stand "Antique"	42
8011.36	buffet stand "Antique"	42
8013	buffet etagere "Stablo"	59
8014.13	buffet stand "Stablo"	57
8014.20	buffet stand "Stablo"	57
8014.20PB	decanter dry rack "Stablo"	185, 189, 190
8015.20	buffet stand "Stablo" S, M, L	57
8015.30	buffet stand "Stablo" S, M, L	57
8015.40	buffet stand "Stablo" S, M, L	57
8016.01	buffet stand "Stablo" XL-ring	57
8017.40	extension "Stablo"	57
8017.60	extension "Stablo"	57
8017.80	extension "Stablo"	57
8018.01	fingerfood tree	103
8018.T	transport bag	103
8019.01	spring clip support	102
8019.02	ring support	102
8019.03	ring support	102
8019.04	ring support	102
8019.05	spiral support	102
8020	buffet platter 1/1 GN, slate	47
8022.02	marble platter	92, 225
8028	sushi plate	169
8034	bowl	92, 169, 225
8035	sushi plate	169
8051	skewer plate, slate	226
8052	marble platter	92, 225
8060.12	buffet display "StiXXX"	27
8060.24	buffet display "StiXXX"	27
8060.36	buffet display "StiXXX"	27
8070.01PB	illuminated wine cooler with stand gift set "Stablo"	57
8080.04	buffet stand "Basic"	30
8080.08	buffet stand "Basic"	30
8080.16	buffet stand "Basic"	30
8080.24	buffet stand "Basic"	30
8081.13	buffet stand "Squareline"	24
8081.25	buffet stand "Squareline"	24
8082.13	buffet stand "Squareline"	24
8082.25	buffet stand "Squareline"	24
8083.01	acrylic connector "Squareline"	24
8083.02	acrylic connector "Squareline"	24
8084.13	buffet stand "Squareline"	24
8084.25	buffet stand "Squareline"	24
8086	etagere "Falcon"	6, 242
8104	LED-light	44

item	description	page
8104.UK	LED-light	44
8104.USA	LED-light	44
8105.01	colour cover	44
8105.02	colour cover	44
8105.03	colour cover	44
8105.04	colour cover	44
8120.01	acrylic glass tube	44
8120.02	acrylic glass tube	44
8120.03	acrylic glass tube	44
8122.10	acrylic glass tube	18, 44
8122.22	acrylic glass tube	18, 44
8122.34	acrylic glass tube	18, 44
8122.58	acrylic glass tube	18, 44
8130	LED-tealight set	270
8131	LED-tealight	270
8132.EU	power supply	270
8132.UK	power supply	270
8132.US	power supply	270
8150	rechargeable LED-light	45
8151	remote control	45
8152.EU	charging device for rechargeable LED-light	45
8152.UK	charging device for rechargeable LED-light	45
8152.US	charging device for rechargeable LED-light	45
8153.01PB	basic ring with LED-light	187
8200.12D	buffet display "Konkret!"	38
8200.12L	buffet display "Konkret!"	39
8200.24D	buffet display "Konkret!"	38
8200.24L	buffet display "Konkret!"	39
8200.36D	buffet display "Konkret!"	38
8200.36L	buffet display "Konkret!"	39
8205.12	buffet display "V12"	28
8205.24	buffet display "V12"	28
8205.36	buffet display "V12"	28
8206.08	buffet display "V12"	28
8206.16	buffet display "V12"	28
8206.24	buffet display "V12"	28
8210.04D	buffet display "Konkret!"	38
8210.04L	buffet display "Konkret!"	39
8210.08D	buffet display "Konkret!"	38
8210.08L	buffet display "Konkret!"	39
8210.12D	buffet display "Konkret!"	38
8210.12L	buffet display "Konkret!"	39
8210.16D	buffet display "Konkret!"	38
8210.16L	buffet display "Konkret!"	39
8210.20D	buffet display "Konkret!"	38
8210.20L	buffet display "Konkret!"	39
8212.D	XXL bowl "Konkret!"	38

item	description	page
8213	rack for XXL bowls	38, 73
8221.08	buffet display "Luxor"	32
8221.16	buffet display "Luxor"	32
8221.24	buffet display "Luxor"	32
8230.08	buffet display "Classy"	35
8230.16	buffet display "Classy"	35
8230.24	buffet display "Classy"	35
8231	buffet display "Classy"	34
8232.24	buffet display "Textura"	12
8232.30	buffet display "Textura"	12
8260.01	buffet display "Spike", set S	11
8260.02	buffet display "Spike", set S	11
8260.03	buffet display "Spike", set S	11
8260.04	buffet display "Spike", set S	11
8260.05	buffet display "Spike", set S	11
8260.10	buffet display "Spike" S - parts	10
8260.1U	buffet display "Spike" S - parts	10
8260.20	buffet display "Spike" S - parts	10
8260.2U	buffet display "Spike" S - parts	10
8261.01	buffet display "Spike", set M	11
8261.02	buffet display "Spike", set M	11
8261.03	buffet display "Spike", set M	11
8261.04	buffet display "Spike", set M	11
8261.10	buffet display "Spike" M - parts	10
8261.1U	buffet display "Spike" M - parts	10
8261.20	buffet display "Spike" M - parts	10
8261.2U	buffet display "Spike" M - parts	10
8262.01	buffet display "Spike", set L	11
8262.10	buffet display "Spike" L - parts	10
8262.1U	buffet display "Spike" L - parts	10
8300.10	buffet stand "Skyline"	18
8300.22	buffet stand "Skyline"	18
8300.34	buffet stand "Skyline"	18
8300.58	buffet stand "Skyline"	18
8305.10	buffet stand "Skyline"	18
8305.22	buffet stand "Skyline"	18
8305.34	buffet stand "Skyline"	18
8305.58	buffet stand "Skyline"	18
8310.22	buffet stand "Curve"	25
8310.46	buffet stand "Curve"	25
8320.15	buffet stand "Crossline"	14, 73
8320.15R	buffet stand "Crossline" - rust	14
8320.31	buffet stand "Crossline"	14, 73
8320.31R	buffet stand "Crossline" - rust	14
8325.23	buffet stand "Crossline"	14
8325.23R	buffet stand "Crossline" - rust	14
8730	buffet bridge "Podia", triple pack	120, 278
8731	buffet bridge "Podia", triple pack	120, 278
8732.03	1/2 GN tray "Podia"	120, 278



# FOR WINE LOVERS

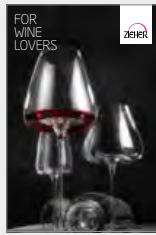

4884.PB	Dekanter/Karaffe „Eddy“ mit Standfuß	189
4890.PB	Dekanter/Karaffe „Pebble“	190
4891.PB	Dekanter/Karaffe „Eddy“ - Mini	188
4892.PB	Dekanter „Star“ mit Vision „Straight“	188
4945.PB	Dekanter/Karaffe „Star“ - Mini	184
4946.PB	Dekanter/Karaffe „Star“ - Mini mit Vision „Straight“	184
4948.PB	Dekanter/Karaffe „Star“ mit Standfuß	185
5480.01	FRESH	194
5480.01-1	FRESH	194
5480.02	STRAIGHT	194
5480.02-1	STRAIGHT	194
5480.03	INTENSE	194
5480.03-1	INTENSE	194
5480.04	BALANCED	195
5480.04-1	BALANCED	195
5480.05	RICH	195
5480.06	NOSTALGIC	195
5480.07	SIDE	195
8014.20PB	Dekanter-Trockengestell „Stablo“	185, 189, 190
8153.01PB	Basising mit LED-Leuchte	187

# FOR DESIGN LOVERS



2120.15PB	bowl "Medusa"	81
2120.25PB	bowl "Medusa"	81
2159.16PB	bowl	84, 223
2159.20PB	bowl	84, 223
2180.22PB	bowl	85
2180.30PB	bowl	85
2189.PB	etagere/pastry stand	244
2200.PB	illuminated champagne bowl	87
2201.PB	etagere with 3 tiers (each 7 miniature plates)	89, 246
2202.PB	etagere with 1 tier (7 miniature plates)	89, 246
2206.50PB	bowl flat	88
2208.13PB	etagere "Flower-Tree"	90, 247
2261.16PB	bowl "Shine"	62
2261.20PB	bowl "Shine"	62
2261.24PB	bowl "Shine"	62
2314.01PB	bowl/basket "Reef"	65
2314.02PB	bowl/basket "Reef"	65
2314.03PB	bowl/basket "Reef"	65
2316.PB	candle holder/wind light "Reef"	66, 269
2317.GPB	napkin ring "Reef"	66, 161
2317.PB	napkin ring "Reef"	66
2336.PB	bowl/basket "Reef"	64
2340.15PB	bowl "Splash"	63
2340.22PB	bowl "Splash"	63
2340.28PB	bowl "Splash"	63
2381.38PB	bowl "Roots"	68
2384.PB	candle holder/wind light "Somnia"	268
4375.01PB	bowl "Cave"	155, 217
4386.PB	plateau plate "DressCoat"	148
4387.PB	plateau plate "DressCoat"	148
4388.PB	plateau plate "DressCoat"	148
4389.25PB	plateau plate/bowl "Cuspis"	144, 172
4501.PB	platter "Collina"	153
4504.PB	platter "Collina"	153
4507.01PB	plate/platter "Pulsar"	142
4507.02PB	plate/platter "Pulsar"	142
4707.PB	servicing tray "Solid"	110, 234, 276
4732.PB	cutting board "Solid"	112
4772.33PB	wooden pillow "Donna"	150, 277
4774.31PB	cutting/snack board "Connect!"	115, 230
4775.44PB	cutting/snack board "Connect!"	115, 230
4776.PB	cutting board "Solid"	104
4882.22PB	cloche with wooden coaster and glass insert	119, 241
4882.30PB	cloche with wooden coaster and glass insert	119, 241
4887.PB	chopsticks with knife rest	168, 202
4914.PB	glass miniature "Amuse"	207
4915.PB	glass miniature "Amuse"	207
4918.PB	glass tin "Amuse"	206
4919.PB	glass tin "Amuse"	206
4920.PB	glass tin "Amuse"	206
4921.PB	glass tin "Amuse"	206
4923.PB	nut bowl "Amuse"	208
4943.08PB	cloche with plateau plate/small bowl "Cuspis"	144, 172, 201
4943.10PB	cloche with plateau plate/small bowl "Cuspis"	144, 172, 201
4943.25PB	cloche with plateau plate/small bowl "Cuspis"	144, 172
4954.03PB	small glass bowl "Halfmoon"	211
4956.02PB	glass bowl	211
4956.03PB	glass bowl	211
4956.04PB	glass bowl	211
5481	champagne flute "Vaganza"	198
5481.GPB	champagne flute "Vaganza"	198
5481.PPB	champagne flute "Vaganza"	198
5482.10PB	glass cloche	142, 179
7109.46PB	bowl "Capiz"	71
8153.01PB	basic ring with LED-light	187

# ZIEHER



*selection*

Zieher "Selection" consists of an exclusive choice of innovative products, which are now made accessible to the high class retail market and thus becoming available for every design favouring end user with a sense for the extraordinary. These items are delivered in gift boxes.

## quick-finder - A to Z glossary

<b>A</b>	
acrylic adapter "Squareline"	24
acrylic insert for wine cooler	20
acrylic tubes	18, 44
"Amuse"	206, 207
Amuse Gueule stand	89-93, 223-225
amuse gueule/tapas spoon	134, 164, 226
"Antique"	42
anti-slip mats "Modul"	137
anti-slip pads	209
"Art de Buffet"	82-101
"Artisan"	78, 79
ashtray	100, 215, 266

<b>B</b>	
<b>BALANCED</b>	195
banquet stand	100
base station for rechargeable LED-light	45
base trays "Modul"	130, 132
"Basic"	30, 31
basic ring with LED-light for decanters	186, 187
basket "Mercato"	106, 107
baskets/bowls "Reef"	64-67
baskets, pewter	64-67
bed tray "Solid", walnut	114, 233, 273
"Bento Box", melamine	122, 123, 229
black glass	50, 54, 165, 264
borosilicate glass	172-176, 184-189, 200-211
bottles, glass	212, 213, 253, 254, 259, 260,
bowl "Capiz"	71
bowl/display "Fakir"	68
bowl, granite	92, 230
bowl "Loop"	83
bowl "Matrix"	68
bowl "Medusa"	81
bowl "Roots"	68
bowl "Splash"	63
bowl, XXL	39, 73, 87
bowls/baskets "Reef"	64-67
bowls, china	144, 148, 155, 156, 162, 164
bowls, glass	8, 10, 12, 70, 72-77, 146, 147, 155, 166, 167, 170
bowls, pewter	63-67
bowls "Solid", walnut	104, 116, 239
bowls, stainless steel	62, 78-88, 222, 223
boxes melamine	122-127, 135, 229
boxes, walnut	36, 117, 234-238, 274, 275
boxes, glass	154, 213, 259, 260
bread basket/box "Solid", walnut	238, 239
bread basket/pastry bowl, stainless steel	84-88
bread cutting board, walnut	104, 112, 115, 230
bridge, melamine	128, 132
bridge, wood	113, 120, 130
buffet bowls, brass	68, 69
buffet bowls "Capiz"	71
buffet bowls, china	156
buffet bowls "Duplex"	76
buffet bowls "Fakir"	68
buffet bowls, glass	8, 10, 12, 70, 72-77
buffet bowls "Loop"	83
buffet bowls "Matrix"	68
buffet bowls "Medusa"	81
buffet bowls "Reef", pewter	64-67
buffet bowls "Roots"	68
buffet bowls, shell	71
buffet bowls "Shine"	62
buffet bowls "Splash"	63
buffet bowls, stainless steel	62, 78-88

buffet bridges "Podia"	120, 278
buffet columns	42, 44
buffet columns "Antique"	42
buffet display "Classy"	34, 35
buffet display "Konkret!"	37-39
buffet display, laminated plastic	27
buffet display "Luxor"	32, 33
buffet display "Mercato"	106, 107
buffet display "Solid"	36, 104-119
buffet display "Somnia"	8, 9
buffet display "Spike"	10, 11
buffet display "Textura"	12, 13
buffet display "V12"	28, 29
buffet etageres	59, 78, 82, 85, 89-91, 94-99
buffet platters, black glass	50
buffet platters, glass	50-54, 57, 72-75
buffet platters, grey glass	53
buffet platters, laminated plastic	48, 49
buffet platters, marble	92
buffet platters, overview	46
buffet platters, satined glass	52
buffet platters, slate	47
buffet platters, structured glass	53
buffet platters, transparent glass	52
buffet platters, white glass	51
buffet sign	100
buffet stands "Basic"	30, 31
buffet stands "Crossline"	14, 15
buffet stands "Curve"	25
buffet stand "Falcon"	6, 7, 242, 243
buffet stands "Skyline"	16-21
buffet stands "Squareline"	22-24
buffet stands "Stablo"	55-59
buffet steps	54
buffet system "Antique"	42
buffet system "Basic"	30, 31
buffet system "Classy"	34, 35
buffet system "Curve"	25
buffet system "Konkret!"	37-39
buffet system "Lightning Buffet"	43-45
buffet system "Luxor"	32, 33
buffet system "Mercato"	106, 107
buffet system "Skyline"	16-21
buffet system "Solid"	36, 104-119
buffet systems overview	26
buffet system "Stablo"	55-59
buffet system "StiXXX"	27
buffet system "Squareline"	22-24
buffet system "V12"	28, 29
buffet trays, stainless steel	79, 84, 95-99
butter/lard pot	213

<b>C</b>	
cake-/pastry stand	118, 185, 242-249
candle holder/windlights	267-270
"Capiz"	71
carafe, glass	170, 183-190
carafe/wine decanter "Eddy"	187-189
carafe/wine decanter "Pebble"	190
carafe/wine decanter "Star"	184, 185
card holders	100
"Catering de Luxe"	156
"Cave"	76, 155
caviar cooler	170, 212
ceramic insert	115, 231
champagne flute "Vaganza"	198
champagne/wine cooler	39, 57, 71, 73, 87
charger plates	158, 180-182
"Chiller-Base"	40, 41
china ball "oro79"	162

china bowls	144, 148, 155, 156, 162, 164
china creamer	216, 218
china miniatures	201, 216-219, 226
china plates	142-145, 148-164
china platter "Collina"	152, 153
china platter "Dots"	154
china platters	142, 151-154, 162
china series "Catering de Luxe"	156
china series "Modul"	164
china series "oro79"	162
china series "Pulsar"	141-143
china series "SelectionA."	157-159
china spoon	226
chocolate/icecube tongs	101, 237
chocolate insert "Solid"	236, 275
chocolate truffle box "Solid"	236, 237, 275
chopstick-/knife rest	168, 202
chopsticks	168, 202
cigars insert "Solid"	236, 275
"Classy"	34, 35
cloches	104, 118, 119, 142-145, 172-179
coat rack "Kibu"	280
cocktail glass	195, 210
coffee cups	210
"Collina"	152, 153
colour covers for LED-light	44
"Connect!"	115, 230
cooling pack for "Chiller-Base"	40, 155
cooling platters "Chiller-Base"	40, 41
cork	212, 213, 251
coup plates	6, 160, 242
creamer, glass	208, 212, 213
creamer china	216, 218
"Crossline"	14, 15
cruet stands, stainless steel	251-261
cups, doublewalled	210
"Curve"	25
"Cuspis"	144, 145, 200, 201
cutlery insert "Solid", walnut	111
cutlery/napkin box, melamine	117, 124
cutlery/napkin box, wood	117, 129, 235
cutting board "Connect!"	115, 230
cutting board, walnut	104, 112, 115, 230

<b>D</b>	
decanter "Eddy"	187-189
decanter, glass	183-190
decanter/carafe "Pebble"	190
decanter/carafe "Star"	184, 185
decanter pedestal for illumination	186, 187
display/bowl "Fakir"	68
"Donna"	150, 151
"Dots"	154
double-walled bowls	38, 62, 71, 207, 210, 211
double-walled glasses	207, 210, 211
"DressCoat"	148, 149
dressing/jam jar	100
dry rack for decanters	185, 189, 190
"Duplex"	76

<b>E</b>	
"Eddy"	187-189
etageres	6, 7, 58, 59, 78, 82, 85, 89-91, 94-99, 242-250
etageres "DressCoat"	94, 245, 279
etageres "Falcon"	6, 7, 242, 243
etageres "Flower-Tower"	89, 246
etageres "Flower Tree", "Flex Tree"	90, 91, 246, 247



# quick-finder - A to Z glossary

extension "Stablo"	57
--------------------	----

## F

"Falcon"	6, 7, 242, 243
"Fakir"	68
"Fingerfood-Tree"	102, 103
"Flex"	202, 203
"Flex Tree"	91, 247
"Flower-Tower" etageres	89, 246
"Flower Tree"	90, 246
fondue set, two parts	156
food display, stainless steel	261
FRESH	194
fruit/bread basket "Reef"	64, 65
fruit/bread basket "Skyline"	20
fruit/bread basket "Solid"	104-106, 116, 244, 245
fruit/bread basket, stainless steel	20, 78, 84-88

## G

glass bottles	212, 213, 253, 254, 259, 260,
glass bowls	8, 10, 12, 70, 72-77, 146, 147, 155, 166, 167, 170
glass bowls "Unique"	146, 147
glass boxes	154, 213, 259, 260
glass cloches	104, 118, 119, 142-145, 172-179
glass coaster	214, 240, 241
glass carafe	170, 183-190
glass, double-walled	207, 210, 211
glass inserts	68, 110, 116, 119, 175, 176, 240, 241
glass miniatures	200-221
glass pillow "Donna"	150
glass plates	143, 146, 147, 150, 163, 165-170
glass plates "Unique"	146, 147
glass platters	50-54, 59, 74-76, 143, 150, 163-170
glass platter/tray GN	165
glass saucer	214, 240, 241
glass series "Amuse"	206, 207
glass series "Flex"	202, 203
glass series "Lacuna"	204, 205
glass series "VISION"	191-197
glass spoon "Cuspis"	200, 226
glass stand for glass cloche	177, 178
glass steps	54
glass straw	204, 210
glass trays	54, 59, 74, 165-167, 170
glass wind lamp	268-270
GN trays	120, 125, 165
GN trays, glass	165
GN trays, melamine	125
granite bowls	92, 230
grate "Solid", walnut	111, 112
grey glass	53, 59, 72-77, 143, 155, 165-167

## H

"Halfmoon"	211
ham holder "Solid"	113
handpump	38, 73, 87
holder for table numbers	100
holder for test tubes	136, 212
honey spoon "Cuspis"	200, 220, 226
hook and loop strap for "Fingerfood-Tree"	103

## I

"Ice"	163
ice cube/chocolate tongs	101, 237

icecream cup	89, 223
"Industry 2.0" buffet platters	49
insert, ceramic	115, 231
insert for chocolates "Solid"	236, 275
insert for cigars "Solid"	236, 275
insert for coffee capsules "Solid"	236, 275
insert for serving tray "Solid", walnut	110, 111, 115, 231
inserts, glass	68, 110, 116, 119, 175, 176, 240, 241
INTENSE	194

## J

jam/dressing jar	100
jam trays	214, 251, 256
juice glass	195, 215, 263
juice jug	170

## K

"Kibu" coat rack	280
knife-/chopstick rest	168, 202
"Konkret!"	37-39

## L

"Lacuna"	204, 205
laminated plastic platters	27, 48, 49, 182
lard pot	213
latte macchiato glass	210
LED-light, cabled	44
LED-light, rechargeable	45
LED pedestal for decanters	186, 187
LED-tealight/set/equipment	270
"Lightning Buffet"	43-45
longdrink glass	210
"Loop"	83
"Luxor"	32, 33

## M

marble platter	92, 224
"Matrix"	68
"Medusa"	81
melamine "Bento Box"	122, 123, 229
melamine boxes	122-127, 135, 229
melamine bridge	128, 132
melamine cutlery/napkin box	117, 124
melamine spoon rest	128, 132
melamine trays	122-128, 132, 227-229, 262, 263
"Ménage-à-trois"	255
"Mercato"	106, 107
mini fork	226
miniature cloches	172-179
miniatures	199-226
miniatures, china	201, 216-219, 226
miniatures, glass	200-221
miniatures, stainless steel	222-226
"Modul"	130-137, 164, 219

## N

napkin/cutlery box, melamine	117, 124
napkin/cutlery box, wood	117, 129, 235
napkin ring	67, 161
NOSTALGIC	195
nut bowl "Amuse"	208

## O

oil/dip bowl	202, 219
"oro79"	162

## P

party spoon, china	226
--------------------	-----

party spoon, stainless steel	134, 226
pastry/bread bowl, stainless steel	84-88
pastry/cake stand	118, 185, 242-249
"Pebble"	190
pedestal/ring, for illumination	186, 187
pepper mill	259
Petit Four stand	89-93, 223-225
pewter	63-67
pillow "Donna"	150, 151
plateau plate "Cuspis", china	144, 145, 200, 201
plateau plate "DressCoat", china	148, 149
plates, china	142-145, 148-164
plates, glass	143, 146, 147, 150, 163, 165-170
plate/saucer, wood	119, 175, 176, 240, 241
platter, china	142, 151-154, 162
platter "Collina"	152, 153
platter "Dots"	154
platter, glass	50-54, 59, 74-76, 143, 150, 163-170
platter "Ice"	163
platter, laminated plastic	27, 48, 49, 182
platter, marble	92, 224
platter, slate	47, 180, 225
platter "Velo"	151
"Podia"	120, 278
porcelain pillow "Donna"	151
presentation box "Solid"	236, 237, 275
presentation tray, stainless steel	88
protecting cap for "Somnia" displays	8
"Pulsar"	141-143
pump for meltwater	38, 73, 87

## R

rack for XXL-bowl "Konkret"	38, 73
rechargeable LED-light	45
"Reef"	64-67, 161, 221
remote control for rechargeable LED-light	45
replacement grate "Solid", walnut	111, 112
RICH	195
ring support for "Fingerfood-Tree"	102
rings "SelectionA.", silicone	77, 158, 185, 188, 209, 212
roomservice tray "Solid", walnut	114, 233, 273
"Roots"	68

## S

salt/pepper mills	259
saucer, glass	214, 240, 241
saucer, silicone	137, 209
saucer, wood	119, 175, 176, 240, 241
"SelectionA."	157-159
serving etageres	242-250
serving tongs	101
serving trays, melamine	122-128, 132, 227-229, 262, 263
serving trays, wood	108-116, 120, 129-131, 230-239, 272-278
serving tray with ceramic insert	115, 231
shell displays "Luxor"	32, 33
shell series "Capiz"	71, 180
"Shine"	62
SIDE	195
side table/tray stand "Solid"	272
silicone holder for test tubes	136, 212
silicone pads/coasters	137, 209
silicone rings "SelectionA."	77, 158, 185, 188, 209, 212
silicone sleeve	19, 24, 98, 137
"Sixth Sense"	83
skewer platter	92, 224, 225

## quick-finder - A to Z glossary

skewers, stainless steel	92, 225
"Skyline"	16-21
slate platters	47, 180, 225
"Slope"	228
small china bowls	201, 216-219, 226
small glass bowls	200-216, 220, 221
"Solid"	36, 104-119, 129, 231-241, 258, 272-276
"Somnia"	8, 9, 268
"Spike"	10, 11
"Splash"	63
spiral support for "Fingerfood-Tree"	102
spiral support for miniatures	92
spoon, china	226
spoon, glass	200, 226
spoon rest, melamine	128, 132
spoon rests	100, 128, 130, 132, 200
spoon rest, wood	130
spring clip support for "Fingerfood-Tree"	102
"Squareline"	22-24
"Stablo"	55-59
stacking bowl "Solid"	104
stacking ring "Solid"	104
stainless steel bowls	62, 78-88, 222, 223
stainless steel cruet stands	251-261
stainless steel etageres	6, 7, 58, 59, 78, 82, 85, 89-91, 94-99, 242-250
stainless steel, hammered	78-101
stainless steel skewers	92, 225
stainless steel tongs	101
stainless steel trays	79, 84, 95-99, 249-251, 257
stand for trays "Solid"	108, 272
"Star"	184, 185
steps, glass	54

"StiXXX"	27
storage box "Solid"	274, 275
storage/transportation box	11, 19
STRAIGHT	194
strap for "Fingerfood-Tree"	103
straw, glass	204, 210
sushi platter	95, 154, 162, 163, 167-170

### T

test tube	136, 212
"Textura"	12, 13
thermo bowls "Shine"	62
thermo glass	207, 210, 211
three-part platter/trays	262-265
toast stand, stainless steel	101, 250
tongs holder, stainless steel	101
tongs, stainless steel	101
transportation/storage box	11, 19
transport bag for "Fingerfood-Tree"	103
tray inserts "Solid"	110, 111
trays for jam	214, 251, 256
trays glass	54, 59, 74, 165-167, 170
trays, melamine	122-128, 132, 227-229, 262, 263
trays, stainless steel	79, 84, 95-99, 249-251, 257
tray stand/side table "Solid"	272
tray stands "Solid"	108, 272
trays with ceramic insert	115, 231
trays wood	108-116, 120, 129-131, 230-239, 272-278
tubes, acrylic glass	18, 44

### U

"Unique"	146, 147
----------	----------

### V

"V12"	28, 29
"Vaganza"	198
"Velo"	151
vinegar/oil bottle, glass	212, 213, 253, 254
"Vintage" buffet platters	49
"VISION"	191-197

### W

walnut adapter "Squareline"	24
walnut bowls "Solid"	104, 116, 239
water glass	195, 215, 263
water glass SIDE	195
white glass	51
wind lights/candle holders	267-270
wine decanter/carafe "Eddy"	187-189
wine decanter/carafe "Pebble"	190
wine decanter/carafe "Star"	184, 185
wine/champagne cooler	39, 57, 71, 73, 87
wine glasses "VISION"	191-197
"Wings" bowl	82
wooden bowls	104, 116, 239
wooden boxes "Solid"	36, 117, 234-238, 274, 275
wooden bridges	113, 120, 130
wooden pillow "Donna"	150
wooden trays/platters	108-116, 120, 129-131, 230-239, 272-278
wooden trays with ceramic insert	115, 231

### X

XXL bowl, concrete semblance	39
XXL bowl, glass	73
XXL bowl, stainless steel	87

## GENERAL CONDITIONS

This catalogue is valid as of March 1st, 2020. Any catalogues and price lists issued previously become invalid as of that date. This catalogue is valid until February 28th, 2021. Misprints and errors excepted. Colour deviations from photographs reserved. All indications of sizes or measurements are approximate ones and subject to alterations. The respective general terms of sale and delivery of our foreign partners apply. For a list of our foreign partners, please consult: [www.zieher.com](http://www.zieher.com). Changes on technical specifications and terms of delivery of the products are reserved and need explicit, written confirmation by Zieher or the respective Zieher business partner.

Photographs are protected by copyright law. Duplication, even in parts, as well as reproduction by photomechanical devices, transfer into systems of electronical data storage and data processing, and adoption of the catalogue layout as well as the use of its parts for advertisement purposes are prohibited and will be legally prosecuted as violations of the German copyright law or the law of competition respectively.



# Making precious materials more precious - whether it is ...

## Glass and china refinement:

Large-scale coatings on glass and china in precious colours enrich every dining table and create luxurious accents!

In order to achieve this decorative style, available in gold, platinum and bronze, the precious metals are burnt onto the varnish at more than 880 °C and as a result, the coating is dishwasher-safe. Cloches made of glass can now be used for serving warm dishes as well and condensing water remains invisible to a great part.

By using resistant precious alloys, we obtain a connection to the varnish, which is strong enough for the products to become dishwasher-safe. Test series by the "Institut für Werkstoffe Heraeus Precious Metals GmbH & Co. KG" have proven the dishwasher resistance of the décor.



Partially, the possibilities of coating are dependent on the form of the product. Requests are being tested in each case according to their feasibility.

The bronze colour is a special case since it presents itself in numerous interesting shades of colour. Depending on the shape of the product, especially when looking at immersions, the colours can vary from gold-bronze shades to blue-violet ones, which blend into each other and create unique effects.

Specific patterns/orders are usually executed quickly. Please do not hesitate to send us your special request!



Satin-coated logos applied before the refinement still remain visible.



### Please note:

Products are dishwasher-resistant. Please take note of the instructions given by dishwasher producers and detergents to avoid damage.

Since the coatings are made of precious metals, the use in microwaves is not recommended under any circumstances.



stainless steel (page 291)



structured glass



glass and china

... glass, china or stainless steel – everything is possible!

## Stainless steel refinement through PVD-technology

Highly polished and matt stainless steel can be refined by using PVD-technology to obtain golden, copper and black colouring.

PVD stands for **Physical Vapour Deposition** and describes a method to coat products with different materials by way of sputtering in a vacuum. Contrary to the galvanic refinement, for example with copper, items refined by using PVD-technology will neither oxidize nor tarnish at the surface. Thus any copper refinement can be done without applying specific anti-tarnish protection. The technical feasibility of PVD-refinement depends on size and shape of the items and has to be checked individually. Price, minimum order quantity and delivery time upon request!

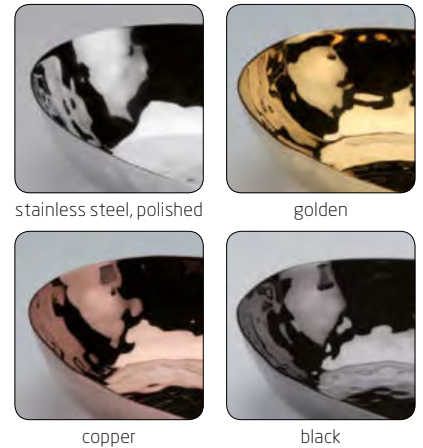

stainless steel, polished

golden

copper

black

## Advantages of the PVD-coating

- Food-safe
- Dishwasher-safe
- Better strength and adherence compared to galvanic refinement
- Brilliant colouring, colourfast and resistant against UV radiation



## Powder-coating:

All items made of stainless steel can be powder-coated in all current RAL colours upon request. In contrast to the PVD refining, this coating is not dishwasher-safe. We will be delighted to advise you!

Please ask us, we will gladly prepare an individual offer for you!

## Individuality in glass ...



Logos, letterings etc. can be put on the double walled glasses to give them an individual touch. Those are applied onto the outer side of the inner glass which ensures the protection from dirt and abrasion.

## ... melamine ...



... china ...



... and stainless steel!



"Curve", page 25



"Podia", page 120



"Mercato", page 106 / 107



"Basic", page 30 / 31



"Konkret!", page 37 to 39



"Solid", page 108 to 119



"Solid", page 104 to 105



"V12" - Carbon, page 28 / 29



"Squareline", page 22 to 24



"Classy", page 34 / 35



"Somnia", page 8 / 9



"Luxor", page 32 / 33



"Spike", page 10 / 11



"Squareline", page 22 to 24



"Skyline", page 16 to 21



"Falcon", page 6 / 7



XXL Bowl, page 73



"Textura", page 12 / 13



"Konkret!", page 37 to 39



"Crossline", page 14 / 15





Our partners, fans and friends, among them many top chefs and sommeliers from all over the world, are using Zieher products to stage drinks and dishes and to present them on social media.

Below is a great collection of very special Zieher moments. Thanks so much for your creativity!



1, 11 MH Cocktail Entertainment, Drink Design by Cocktail World Champion Mario Hofferer, mario-hofferer.com, Fotograf Tine Steinhäler | 2 Ulric Nijs, bar-face.com | 3, 14 Fabian Sanger, Sweet Life: Rezepte fur Patisserie, fabiansaenger.com „GOURMAND world cookbook awards“ | 4 Olivier Gagne, instagram.com/oliviergagne38 | 5 Andy Gaskin, instagram.com/kitchenandy0808 | 6, 7 eat! Berlin bei Kunst&Kulinarik | 8, 9, 10, 12 Hane Garza, Workshop TallerJ, Monterrey, Mexico | 13 Daniel Klein, Restaurant [KOOK] 36 in Moos

Follow us on social media and stay tuned!



facebook.com/ZieherGermany



instagram.com/Zieher\_Selection



linkedin.com/company/zieher-kg



xing.com/companies/zieherkg



# #ziehermoment



15 Marcel Thiele, [instagram.com/thiele.marcel](https://www.instagram.com/thiele.marcel) | 16 Marcel Thiele, [instagram.com/thiele.marcel](https://www.instagram.com/thiele.marcel) | 17 Ulric Nijs, [bar-face.com](https://www.bar-face.com) | 18 eat! Berlin bei Kunst&Kulinarik | 19 Fabian Sanger, Sweet Life: Rezepte fur Patisserie, [fabiansaenger.com](https://www.fabiansaenger.com) „GOURMAND world cookbook awards“ | 20 Enrico Quarta Colosso, @dilettaqc for @enrico.onthewine | 21 Gilbert Bages, [instagram.com/drinkinmoderation](https://www.instagram.com/drinkinmoderation) | 22 Best Events Catering, [instagram.com/besteventscatering](https://www.instagram.com/besteventscatering) | 23, 25 Hane Garza, Workshop TallerJO, Monterrey, Mexico | 24 Vincenzo Lanzilotti

Follow us on social media and stay tuned!



[youtube.com/user/ZieherGermany](https://www.youtube.com/user/ZieherGermany)



[pinterest.de/zieherkg/](https://www.pinterest.de/zieherkg/)



[zieher.com/blog/](https://zieher.com/blog/)







The founders of the company Christa (middle) and Manfred Zieher (2nd from left) with their sons Dominik (left) and Oliver (right), responsible for global sales resp. marketing and design. Daughter Jennifer (2nd from right) is in charge of controlling.

### 31 years of culinary art by Thomas Dötzer:

- 31 years of friendship
- 31 years of culinary highlights
- 31 years of know-how, consultancy and expertise
- 31 years of food-styling and dexterity
- 31 years of support and inspiration

### 31 years of visual arts by Gerd Preiß:

- 31 years of perspective and composition
- 31 years of pictorial language and emotion
- 31 years of food-styling and photography
- 31 years of know-how and consultancy
- 31 years of commitment, support and friendship



Gerd Preiß

Thomas Dötzer

Many thanks!

Our experts after work:

**Thomas Dötzer**, Dötzer Restauration  
([www.doetzers.de](http://www.doetzers.de))

**Gerd Preiß**, Photographer  
([www.die-lichtzeichner.de](http://www.die-lichtzeichner.de))



WWW.ZIEHER.COM



## ZIEHER KG

Kulmbacher Str. 15  
95502 Himmelkron  
Germany

Tel.: +49 9273 / 92 73 40  
Fax: +49 9273 / 92 73 74  
E-Mail: [info@zieher.com](mailto:info@zieher.com)

[WWW.ZIEHER.COM](http://WWW.ZIEHER.COM)

Valid until **February 28<sup>th</sup>, 2021**